

500 mA, 6 MHz synchronous step-down converter

Datasheet - production data

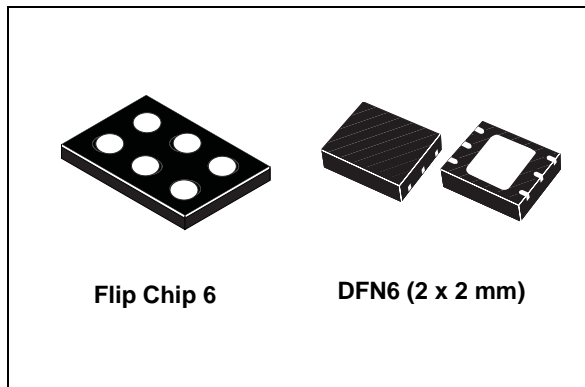

applications where high efficiency and small application area are the key factors. With an output voltage as low as 0.6 V the device supports low voltage DSPs and processors core supply. Due to the 6 MHz switching frequency the ST1S15 can use nominal values of 470 nH for the inductor and 4.7 μ F for the output capacitor, providing, at the same time, very good performance in terms of load and line transients. It is possible to select a PFM mode for high efficiency under light load conditions or PWM mode for tight regulation and best dynamic performance. Short-circuit and thermal protection are also included.

Features

- 85% typical efficiency
- 500 mA output current capability
- 45 μ A typical quiescent current
- PFM or PWM operation for best efficiency over whole load range
- Ultra-fast load and line transient
- Short-circuit and thermal protection
- Tiny external components
- Auto or forced PWM selection with dedicated pin
- Available in Flip Chip 6 and DFN6 (2 x 2 mm) packages

Table 1. Device summary

Order codes	Output voltages (V)	Packages
ST1S15J18R	1.82	Flip Chip 6
ST1S15J28R	2.8	
ST1S15TPUR	1.82	DFN6 (2 x 2 mm)
ST1S15-28TPUR	2.8	

Applications

- DSP and multimedia processors core supply
- Cell phones
- PDAs

Description

The ST1S15 is a high efficiency miniaturized step-down converter able to provide 500 mA output current from an input voltage from 2.3 V to 5.5 V. This converter is specifically designed for

Contents

1	Application schematic	3
2	Pin configuration	4
3	Maximum ratings	5
4	Electrical characteristics	6
5	Typical performance characteristics	8
6	Block schematic	12
7	Detailed description	13
	7.1 General description	13
	7.2 Mode transition	13
	7.3 Soft-start	14
	7.4 Short-circuit protection	14
	7.5 Undervoltage lockout (UVLO)	14
	7.6 Thermal protection	15
	7.7 Overcurrent protection	15
	7.8 Enable function	15
8	Application Information	16
	8.1 Input and output capacitor	16
	8.2 Inductor	16
	8.3 Layout guidelines	17
9	Package mechanical data	18
10	Different output voltage versions of the ST1S15	
	available on request	26
11	Revision history	27

1 Application schematic

Figure 1. ST1S15 application schematic

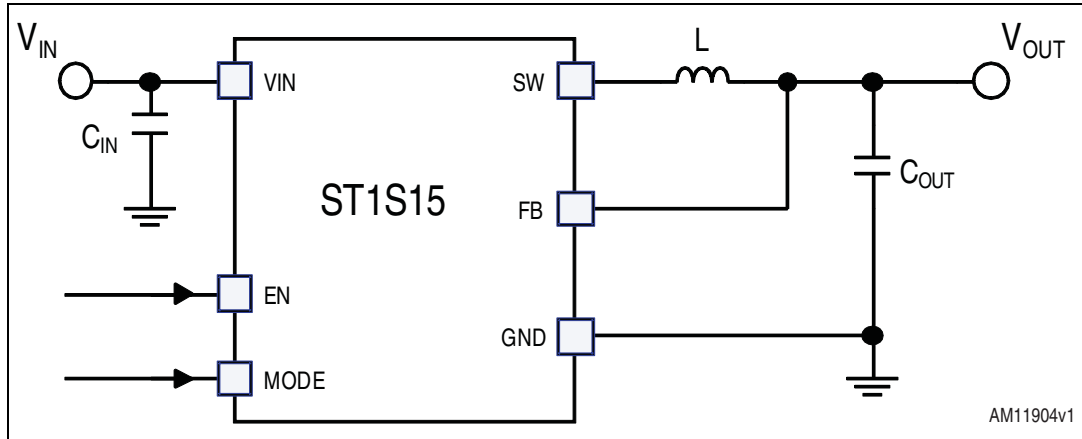

Table 2. Typical external components

Component	Manufacturer	Part number	Value	Size
C_{IN}	Murata	GRM155R60J475ME87	4.7 μ F	0402
C_{OUT}	Murata	GRM155R60G475ME87 ⁽¹⁾	4.7 μ F	0402
		GRM155R60J475ME87		
L	Murata	LQM21PNR47MC0D	470 nH	2.0 x 1.25 x 0.5 mm

1. For $V_{OUT} \leq 1.82$ V.

Note: All the above components refer to a typical application. Operation of the ST1S15 is not limited to the choice of these external components.

2 Pin configuration

Figure 2. Pin connections (top view)

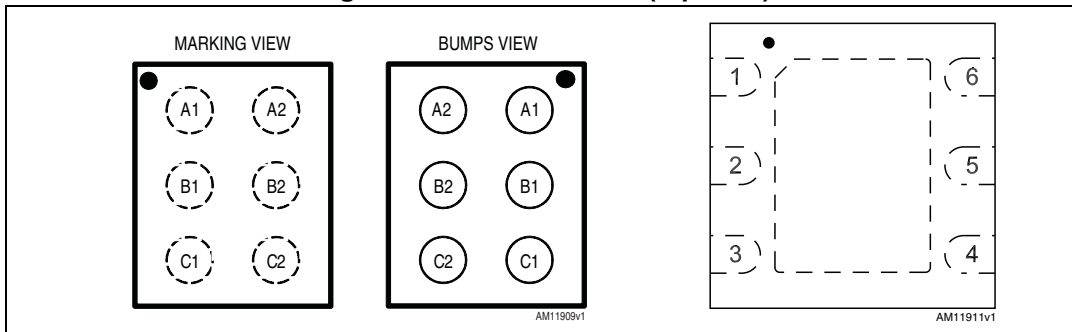

Table 3. Pin description

Pin name	Flip Chip	DFN6	Description
V _{IN}	A2	1	High-side switch connection and IC supply.
EN	B2	2	ENABLE pin with positive logic. The IC goes into shutdown if pulled low. Do not leave this pin floating.
GND	C2	3	Power and IC supply ground.
FB	C1	4	Feedback input.
SW	B1	5	Inductor connection to internal PFET and NFET.
MODE	A1	6	Operation mode selection: - LOW => Automatic operation PFM or PWM according to output load; - HIGH => Forced PWM operation. Do not leave this pin floating.
Epad	-	Epad	Exposed pad to be connected to ground

3 Maximum ratings

Table 4. Absolute maximum ratings

Symbol	Parameter	Value	Unit
V_{IN}	Power and signal supply voltage	- 0.3 to + 6.0	V
EN, MODE	Logic input pins	- 0.3 to + 6.0	V
FB, SW	Feedback and switching pins	-0.3 to $V_{IN} + 0.3$	V
T_{AMB}	Operating ambient temperature	- 40 to 85	°C
T_J	Junction temperature	- 40 to 150	°C
T_{STG}	Storage temperature	- 65 to 150	°C

Note: Absolute maximum ratings are those values beyond which damage to the device may occur. Functional operation under these conditions is not implied.

Table 5. Thermal data

Symbol	Parameter	DFN6	Flip Chip	Unit
R_{thJA}	Thermal resistance junction-ambient	80	130	°C/W

Table 6. ESD performance

Symbol	Parameter	Value	Unit
ESD	Human body model	± 2000	V
	Machine model	± 100	

4 Electrical characteristics

- 40 °C < T_A < 85 °C, C_{IN} = 4.7 µF nominal, C_{OUT} = 4.7 µF nominal, L = 470 nH, typical values are at T_A = 25 °C, V_{EN} = V_{IN} unless otherwise specified.

Table 7. Electrical characteristics

Symbol	Parameter	Test conditions	Min.	Typ.	Max.	Unit
General section						
V _{IN}	Operating input voltage range		2.3		5.5	V
V _{UVLO}	Undervoltage lockout threshold	V _{IN} rising		2.1	2.2	V
		V _{IN} falling	1.8	1.9		
I _Q	PFM mode quiescent current	No load		45	60	µA
	PWM mode quiescent current	No load		15		mA
	Shutdown current	V _{EN} = 0		0.5	5	µA
f _{SW}	Switching frequency		5.4	6	6.6	MHz
I _{OUT}	Continuous output current ⁽¹⁾	V _{IN} ≥ V _{OUT} + 0.40 V	500			mA
I _{SC}	Short-circuit current ⁽²⁾				1200	mA
I _{PFM-PWM}	PFM to PWM transition	V _{IN} = 3.6V, V _{OUT} = 1.82 V		200		mA
	PWM to PFM transition			100		
h	Efficiency (V _{IN} = 3.6 V, V _{OUT} = 1.82 V)	I _{OUT} = 10 mA PFM mode		80		%
		I _{OUT} = 150 mA		83		
t _{ON}	Startup time	V _{EN} from low to high, V _{IN} = 3.6 V, V _{OUT} = 1.82 V		260		µs
T _{SHDN}	Thermal shutdown			125		°C
	Hysteresis			30		°C
Output voltage						
V _{OUT}	Accuracy (ST1S15x18)	2.3 ≤ V _{IN} ≤ 5.5 V, I _{OUT} = 10 mA, PWM mode, -40 ≤ T _A ≤ 85 °C	1.78	1.82	1.86	V
		2.3 ≤ V _{IN} ≤ 5.5 V, I _{OUT} = 10 mA, PFM mode, -40 ≤ T _A ≤ 85 °C	1.78	1.82	1.86	
	Load regulation	2.3 ≤ V _{IN} ≤ 5.5 V, V _{OUT} = 1.82 V, I _{OUT} = 0 to 500 mA, PWM mode, -40 ≤ T _A ≤ 85 °C		-1.5		%
	Accuracy (ST1S15x28)	3.2 ≤ V _{IN} ≤ 5.5 V, I _{OUT} = 10 mA, PWM mode, -40 ≤ T _A ≤ 85 °C	2.74	2.8	2.86	V
		3.2 ≤ V _{IN} ≤ 5.5 V, I _{OUT} = 10 mA, PFM mode, -40 ≤ T _A ≤ 85 °C	2.74	2.8	2.86	
Load regulation	3.2 ≤ V _{IN} ≤ 5.5 V, V _{OUT} = 2.8 V, I _{OUT} = 0 to 500 mA, PWM mode, -40 ≤ T _A ≤ 85 °C		-1.5		%	

Table 7. Electrical characteristics (continued)

Symbol	Parameter	Test conditions	Min.	Typ.	Max.	Unit
V_{OUT_Ripple}	Peak-to-Peak output voltage ripple	PWM mode, $I_{OUT} = 150\text{ mA}$, $V_{IN} = 3.6\text{ V}$, $V_{OUT} = 1.82\text{ V}$		10		mV
		PFM mode, $I_{OUT} = 150\text{ mA}$, $V_{IN} = 3.6\text{ V}$, $V_{OUT} = 1.82\text{ V}$		30		mV
I_{LKFB}	FB pin leakage current	$V_{FB} = 5.5\text{ V}$			9	μA
V_{IN_TR}	Line transient response. Output voltage variation over nominal DC level. $t_R = t_F = 10\text{ }\mu\text{s}$ Case 1: $V_{IN} = 2.5\text{ to }3.1\text{ V}$ Case 2: $V_{IN} = 3.9\text{ to }4.5\text{ V}$	$I_{OUT} = 50\text{ mA}$, $V_{OUT} = 1.82\text{ V}$		± 50		mV
		$I_{OUT} = 250\text{ mA}$, $V_{OUT} = 1.82\text{ V}$				
I_{OUT_TR}	Load transient response $t_R = t_F = 0.1\text{ }\mu\text{s}$. Case 1: $V_{IN} = 2.5\text{ V}$ Case 2: $V_{IN} = 3.6\text{ V}$ Case 3: $V_{IN} = 4.5\text{ V}$	$I_{OUT} = 0\text{ to }150\text{ mA}$, $V_{OUT} = 1.82\text{ V}$		± 50		mV
		$I_{OUT} = 50\text{ to }250\text{ mA}$, $V_{OUT} = 1.82\text{ V}$		± 70		
		$I_{OUT} = 150\text{ to }400\text{ mA}$, $V_{OUT} = 1.82\text{ V}$		± 70		
Logic Inputs						
V_{IL}	Low-level input voltage (EN, MODE pins)				0.4	V
V_{IH}	High-level input voltage (EN, MODE pins)		1.2			V
I_{LK-I}	Input leakage current (EN, MODE pins)	$V_{EN} = V_{MODE} = 5.5\text{ V}$		0.01	1	μA
Power Switches						
R_{DSON}	P-channel MOSFET on-resistance			300	400	m Ω
	N-channel MOSFET on-resistance			350	450	
I_{LPEAK}	P-channel peak current limit	Over input voltage range	900	1000	1200	mA
I_{LKG-P}	P-channel leakage current	$V_{IN} = 5.5\text{ V}$, $V_{EN} = 0$			1	μA
I_{LKG-N}	N-channel leakage current	$V_{SW} = 5.5\text{ V}$, $V_{EN} = 0$			1	μA

1. Not tested in production. This value is guaranteed by correlation with R_{DSON} , peak current limit and operating input voltage.
2. Not tested in production. This parameter is guaranteed by peak current limit.

5 Typical performance characteristics

Figure 3. Efficiency vs. output current
($V_{OUT} = 1.82\text{ V}$)

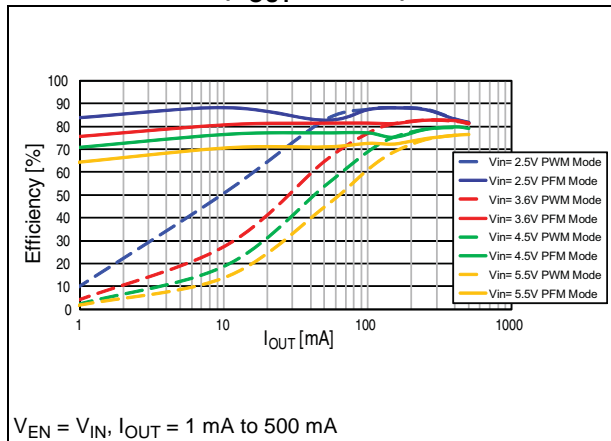

Figure 4. Efficiency vs. output current
($V_{OUT} = 2.8\text{ V}$)

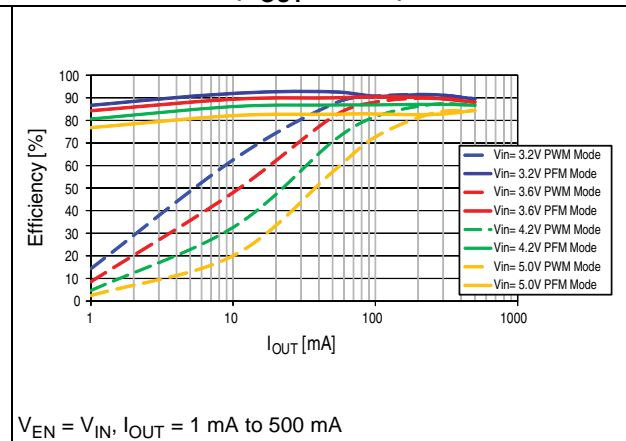

Figure 5. Output voltage vs. input voltage

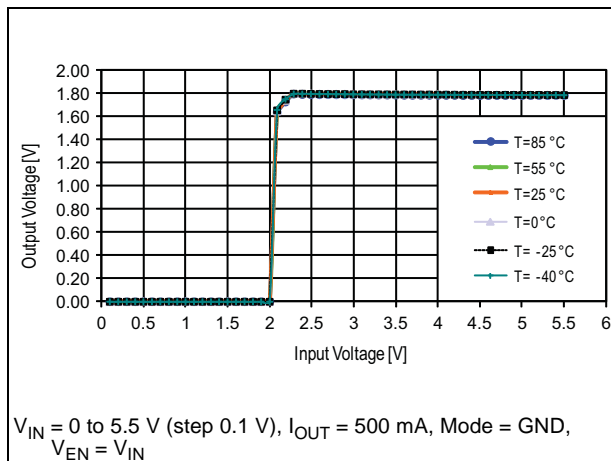

Figure 6. Supply current vs. input voltage in auto mode

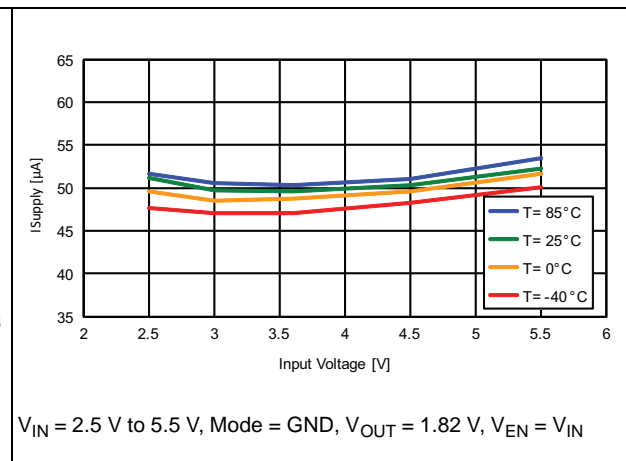

Figure 7. Supply current vs. input voltage in PWM mode

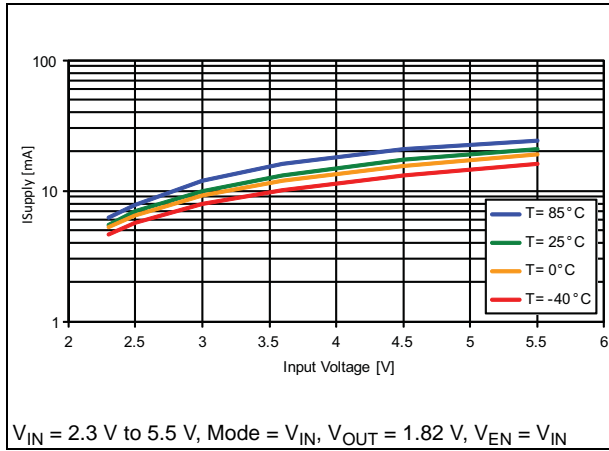

Figure 8. Output voltage vs. output current

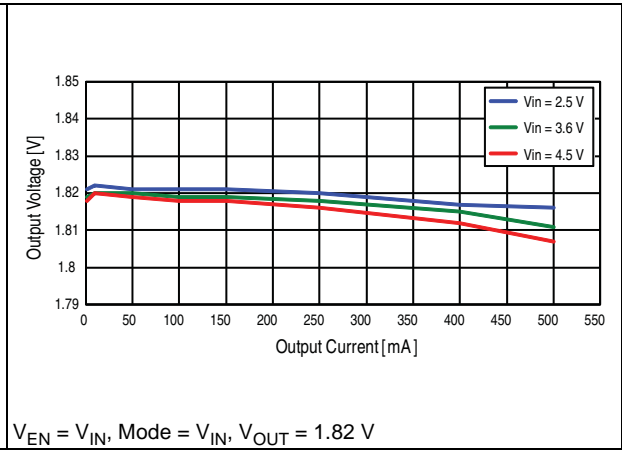

Figure 9. Frequency vs. input voltage

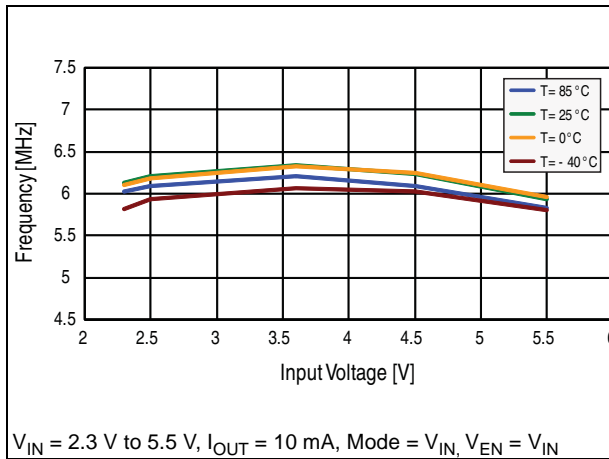

Figure 10. Output voltage vs. output current

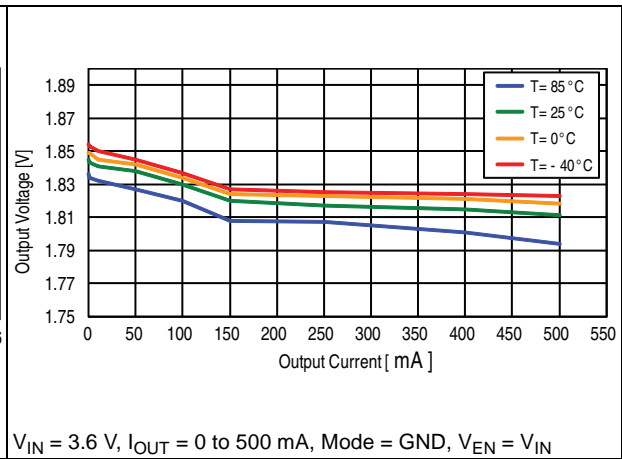

Figure 11. Mode transition vs. input voltage

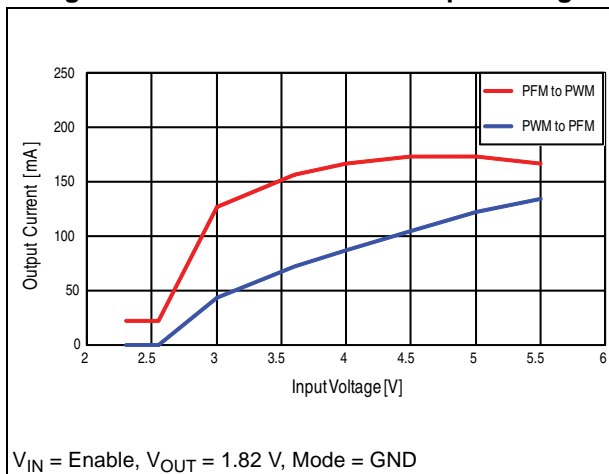

Figure 12. Mode transition PFM to PWM

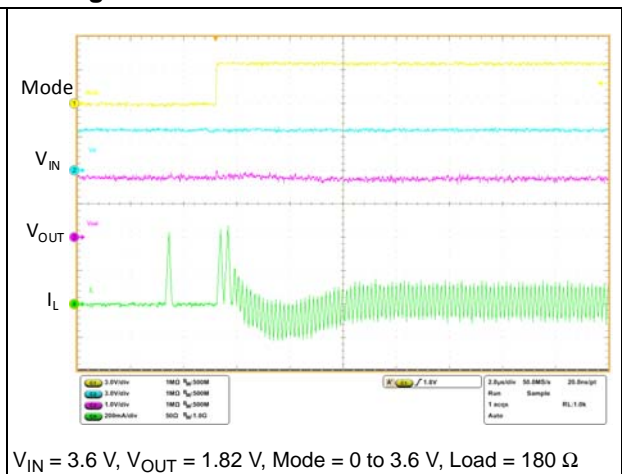

Figure 13. Mode transition PWM to PFM

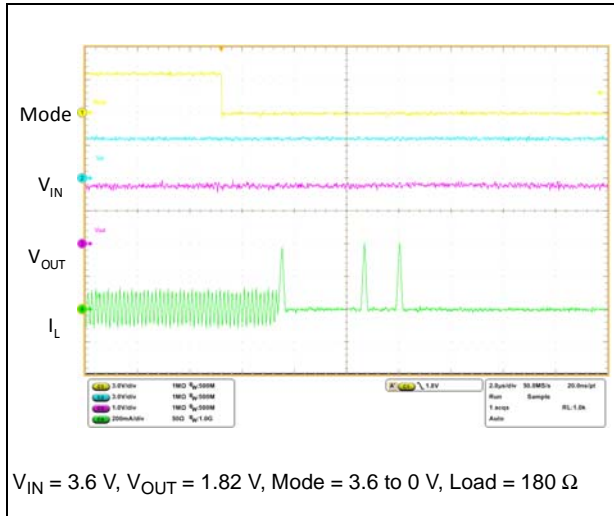

Figure 14. Output voltage ripple

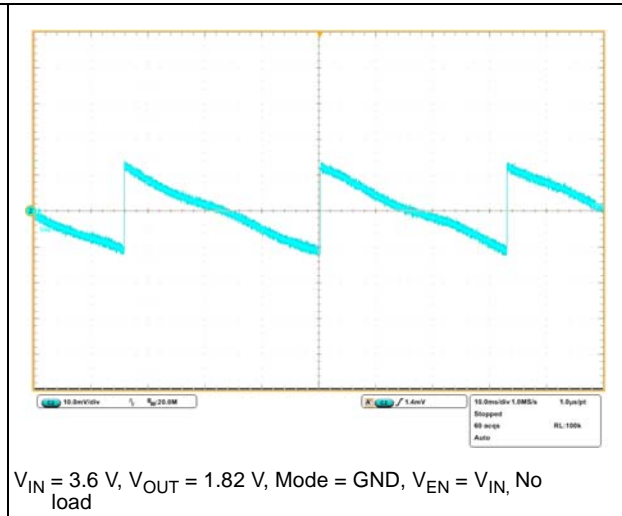

Figure 15. Output voltage ripple

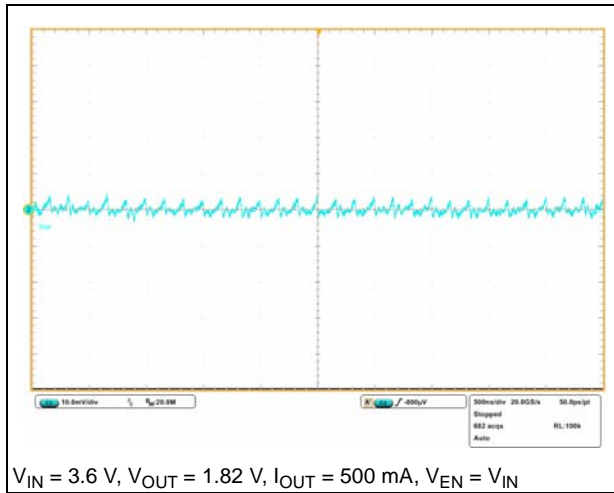

Figure 16. Line transient

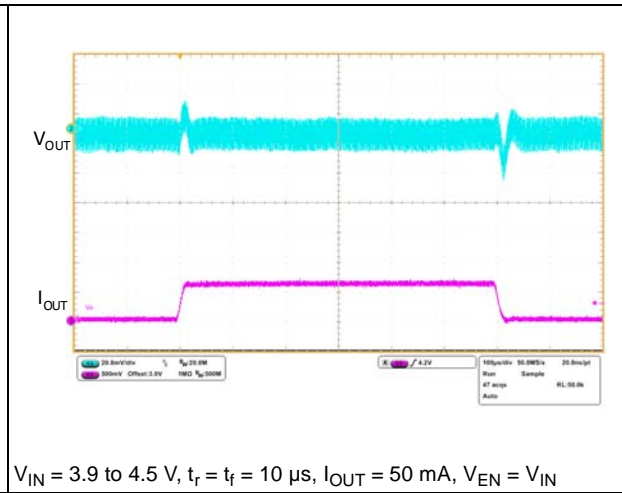

Figure 17. Load transient $I_{OUT} = 50$ to 250 mA

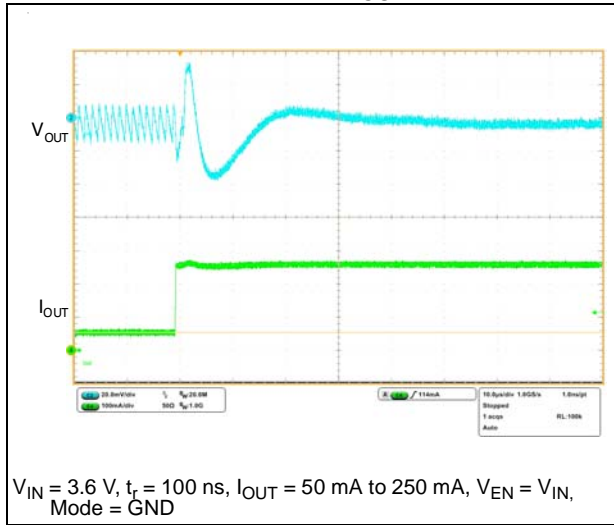

Figure 18. Load transient $I_{OUT} = 250$ to 50 mA

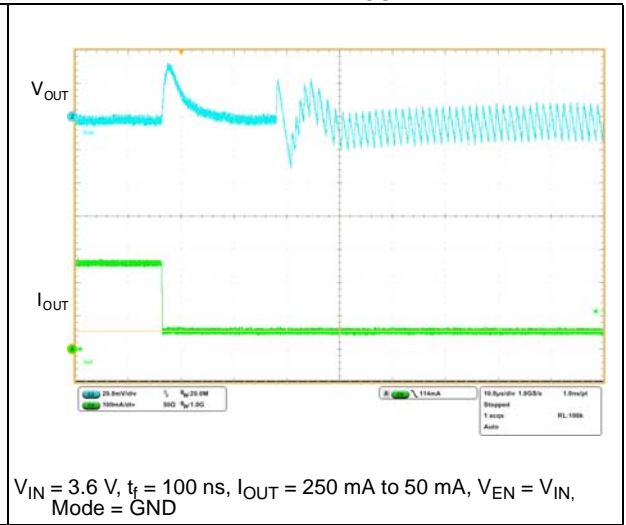

Figure 19. Enable startup

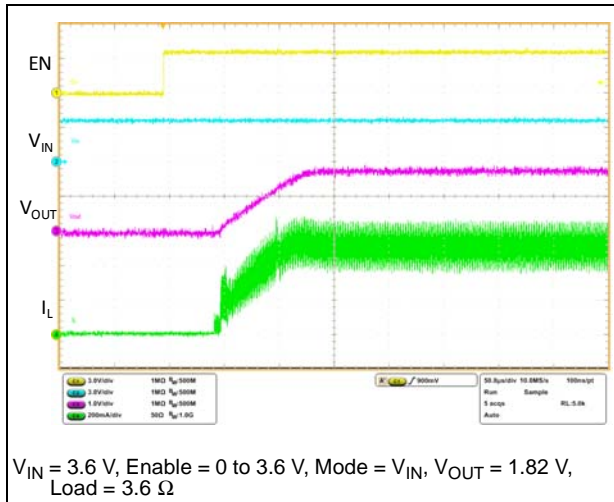
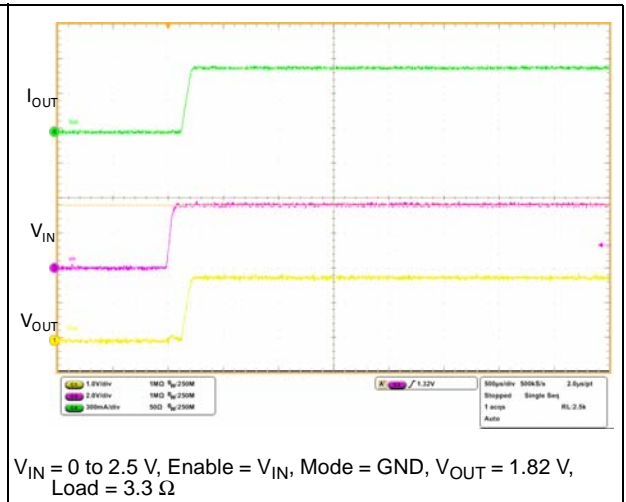
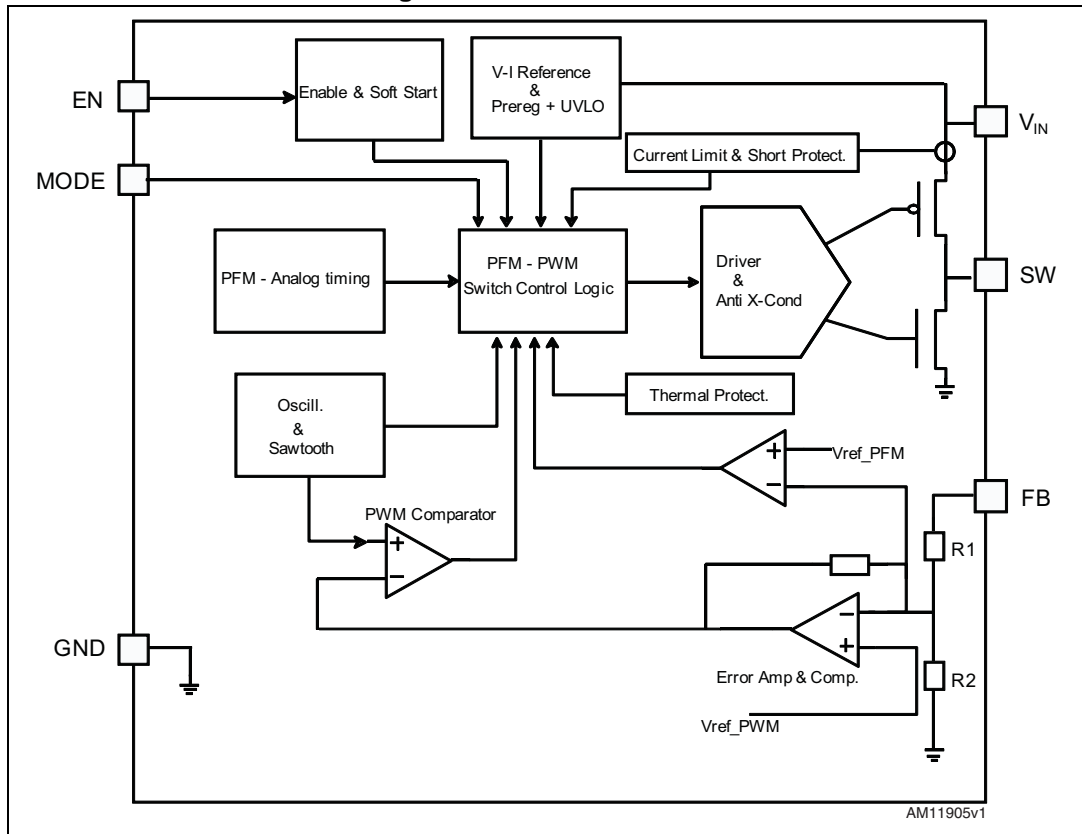

Figure 20. V_{IN} startup



6 Block schematic

Figure 21. Block schematic



7 Detailed description

7.1 General description

The ST1S15 is a fixed voltage mode PWM step-down DC-DC converter which operates with typically 6 MHz fixed frequency pulse width modulation (PWM) at moderate to heavy load currents. At light load currents the converter can automatically enter PFM (pulse frequency mode) mode.

To make the device work, few components are required: an inductor and two capacitors. It has been designed to work properly with X5R or X7R SMD ceramic capacitors both at the input and at the output. These kinds of capacitors, thanks to their very low series resistance (ESR), minimize the output voltage ripple. In addition, the chosen inductor must be able to not saturate at the peak current level.

7.2 Mode transition

The ST1S15 can work in PWM mode or in PFM mode according to the different operating conditions. If the MODE pin is pulled high, the device works only in PWM mode even at light or no load. If the MODE pin is low, the operation changes according to the average input current handled by the device. At low output current the device works in PFM mode in order to obtain very low power consumption and very good efficiency. When the output current increases, the device automatically switches to PWM mode in order to deliver the power needed by the load.

The ST1S15 passes from PFM to PWM when 3 consecutive PFM pulses occur. This means that the PFM has reached its maximum current capability and the device needs to go into PWM mode. The whole PWM circuitry starts after a transition time. During this time the duration of the PFM pulses are increased to about 350 ns so as to provide higher current capability. After startup of the PWM circuitry, the ST1S15 switches to PWM operation.

Figure 22. PFM to PWM transition

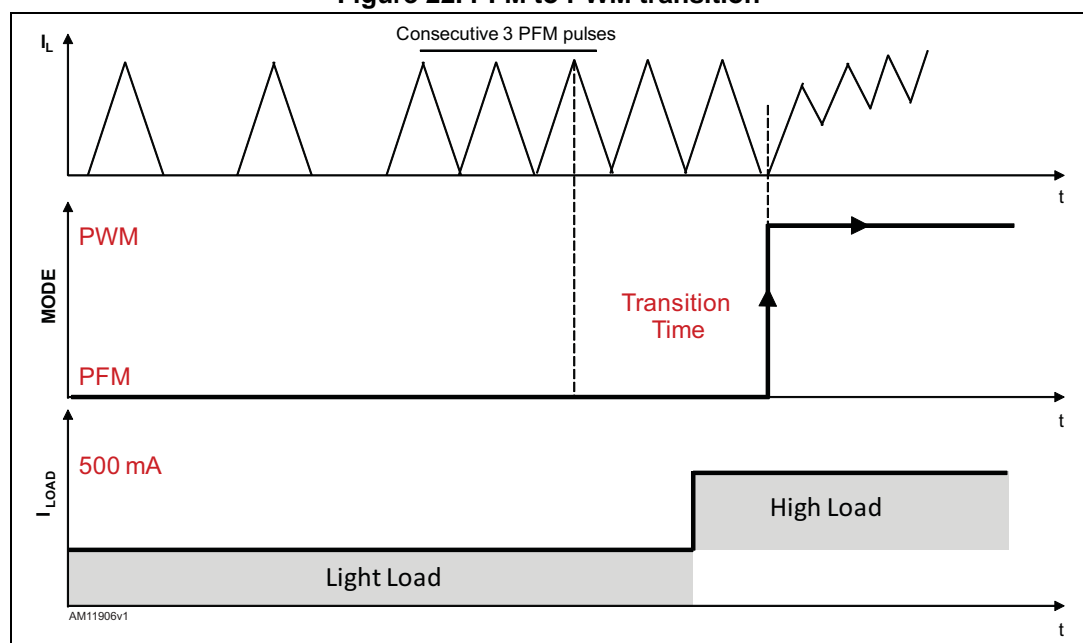

The transition from PWM to PFM mode occurs when the load current decreases and the coil current becomes negative. After the zero-crossing output goes up for 127 consecutive times the device switches to PFM mode.

Figure 23. PWM to PFM transition

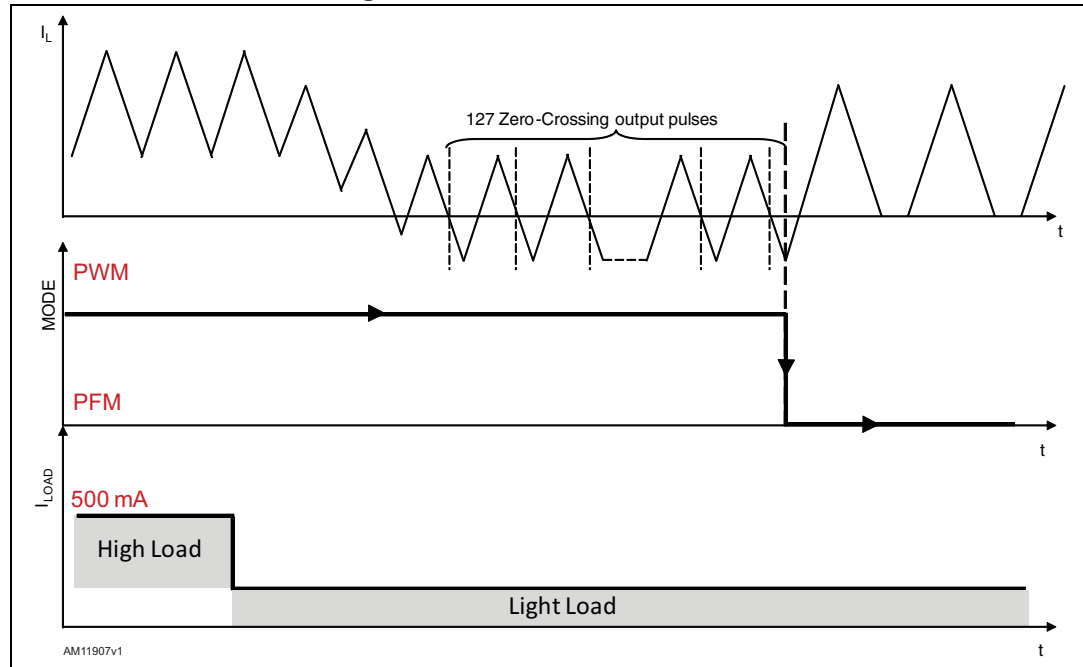

7.3 Soft-start

The internal soft-start is enabled after V_{IN} reaches the UVLO threshold and the EN pin is high or for startup after enable. An overtemperature shutdown event or over short-circuit event also activates the soft-start sequence.

It eliminates the in-rush current problem during the startup phase. During the soft-start the device works always in PWM regardless of the status of the Mode pin.

7.4 Short-circuit protection

The short-circuit protection begins when there is a short between the device output and ground. In this case the output voltage value is lower than the voltage reference and the overcurrent protection comparator output is high. When this happens the power stage (Pch and Nch) turns off and a soft-start phase starts. The device repeats the soft-start sequence during the short-circuit condition.

7.5 Undervoltage lockout (UVLO)

The UVLO circuit prevents the device from malfunctioning when the input voltage is not high enough. The device is in shutdown mode, when the input voltage is below the UVLO threshold. The hysteresis of 200 mV prevents unstable operation when the input voltage is close to the UVLO threshold.

7.6 Thermal protection

The device also has thermal shutdown protection, which is active when the junction temperature reaches 125 °C. In this case both the high and low-side MOSFETs are turned off.

Once the junction temperature goes back below 95 °C, the device resumes normal operation.

7.7 Overcurrent protection

The overcurrent protection is used to limit the maximum inductor current. This current flowing through the Pch of the power stage causes a voltage drop, across its RDSON, at the switching node. A comparator compares the switching node voltage with a reference voltage VR. To generate the VR voltage a current generator is used, which causes a drop across a Pch of the same kind as the power stage. When the switching node voltage is lower than VR, the comparator output goes high and the power Pch turns off.

7.8 Enable function

The ST1S15 features an enable function (pin 2 or B2). When the EN voltage is higher than 1.2 V the device is ON, and if it is lower than 0.4 V the device is OFF. In shutdown mode the consumption is lower than 5 μA.

The EN pin does not have an internal pull-up, which means that the EN pin cannot be left floating.

If the enable function is not used, the EN pin must be connected to V_{IN} .

8 Application Information

8.1 Input and output capacitor

It is recommended to use ceramic capacitors with X5R or X7R dielectric and low ESR. The input capacitor is used to filter any disturbance present in the input line and to obtain stable operation. The output capacitor is very important to satisfy the output voltage ripple requirement.

The output voltage ripple (V_{OUT_RIPPLE}), in continuous mode, must be calculated:

Equation 1

$$V_{OUT_RIPPLE} = \Delta I_L \times \left[ESR + \frac{1}{8 \times C_{OUT} \times f_{SW}} \right] + \frac{V_{IN} \times ESL}{L}$$

where ΔI_L is the ripple current and f_{SW} is the switching frequency.

The use of ceramic capacitors with voltage ratings in the range higher than 1.5 times the maximum input or output voltage is recommended.

8.2 Inductor

The inductor is the key passive component for switching converters. The internal compensation is optimized to operate with an output filter of $L = 0.47 \mu H$ and $C_{OUT} = 4.7 \mu F$.

In addition to the inductance value, in order to avoid saturation, the maximum saturation current of the inductor must be higher than that of the I_{PEAK} .

The peak current of the inductor must be calculated as:

Equation 2

$$I_{PEAK} = I_{OUT} + \frac{V_{OUT} \times (V_{IN_MAX} - V_{OUT})}{2 \times V_{IN_MAX} \times f_{SW} \times L}$$

The following inductor p/ns from different suppliers have been tested in the ST1S15 converters.

Table 8. Inductors

Manufacturers	p/ns	Dimensions (in mm)
Murata	LQM21PNR47MC0D	2.0 x 1.25 x 0.5
	LQM21PNR54MG0D	2.0 x 1.25 x 0.5
	LQH32PNR47NN0L	3.2 x 2.7 x 1.55
TDK	MLP2012SR47T	2.0 x 1.25 x 0.5
	VLS2010ET-1R0N	2.0 x 2.0 x 1.0

8.3 Layout guidelines

Due to the high switching frequency and peak current, the layout is an important design step for all switching power supplies. If the layout is not done carefully, important parameters such as stability, efficiency, line and load regulation and output voltage ripple may be compromised.

Short, wide traces must be implemented for main current and for power ground paths. The input capacitor must be placed as close as possible to the device pin as well as the inductor and output capacitor.

The FEEDBACK pin (FB) is a high impedance node, so the interference can be minimized by placing the routing of the feedback node as far as possible from the high current paths.

A common ground node minimizes ground noise.

The exposed pad of the DFN package must be connected to the common ground node.

Figure 24. DFN layout recommended (not to scale)

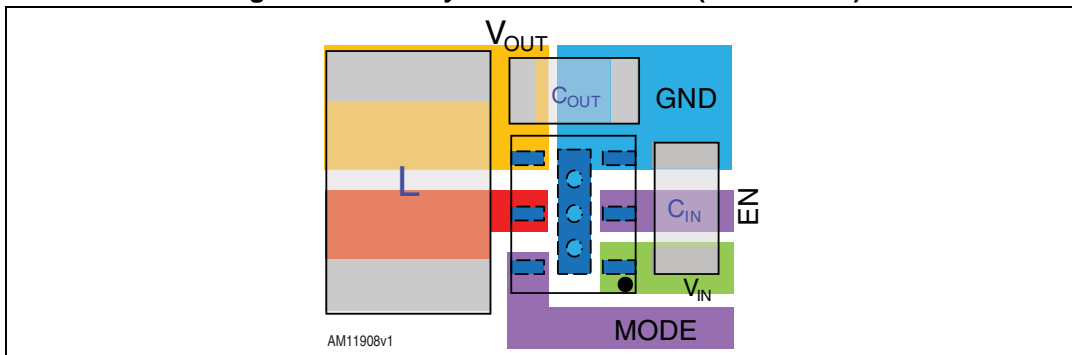
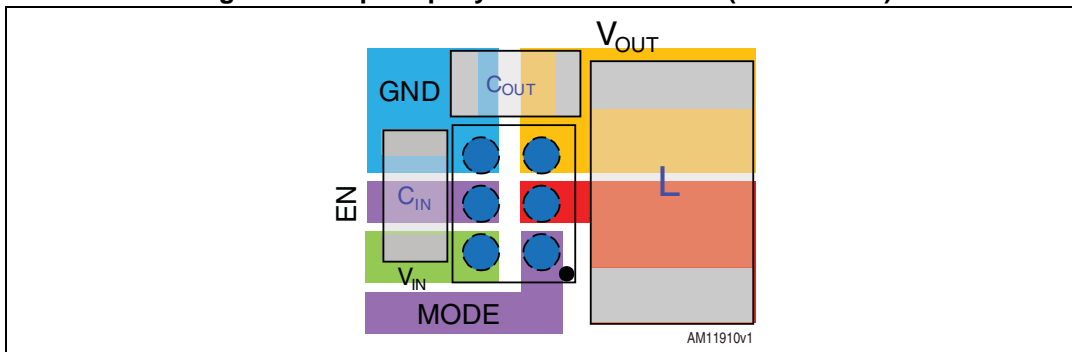

Figure 25. Flip-Chip layout recommended (not to scale)



9 Package mechanical data

In order to meet environmental requirements, ST offers these devices in different grades of ECOPACK[®] packages, depending on their level of environmental compliance. ECOPACK specifications, grade definitions and product status are available at: www.st.com. ECOPACK is an ST trademark.

Table 9. DFN6 (2 x 2 mm) mechanical data

Dim.	(mm)		
	Min.	Typ.	Max.
A	0.51	0.55	0.60
A1	0	0.02	0.05
b	0.18	0.25	0.30
D		2.00	
D2	1.30	1.45	1.55
E		2.00	
E2	0.85	1.00	1.10
e		0.50	
L	0.15	0.25	0.35

Figure 26. DFN6 (2 x 2 mm) package dimensions

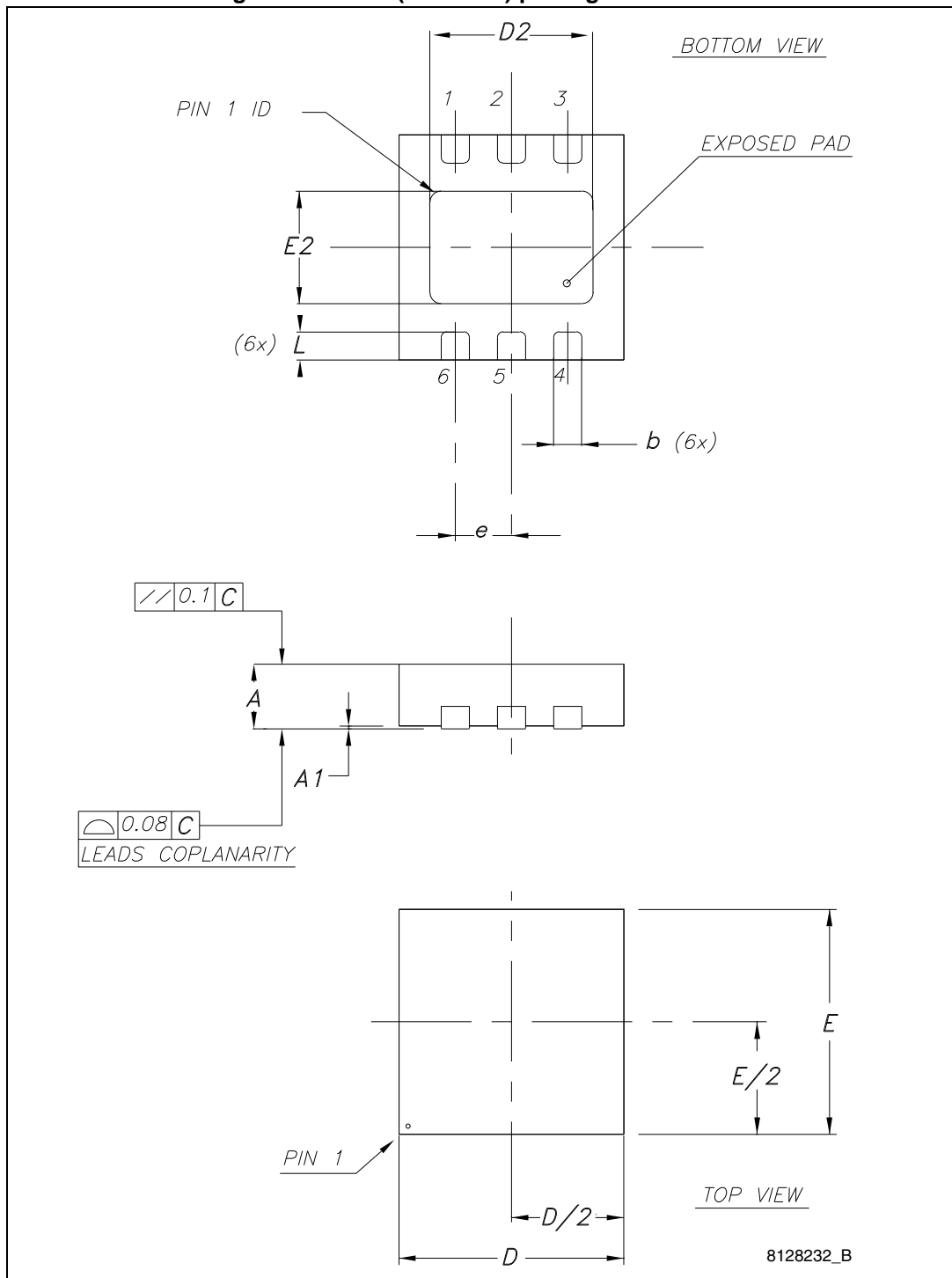

Table 10. Flip Chip 6 mechanical data

Dim.	(mm)		
	Min.	Typ.	Max.
A	0.52	0.56	0.6
A1	0.17	0.20	0.23
A2	0.35	0.36	0.37
b	0.23	0.25	0.29
D	1.16	1.19	1.22
D1		0.8	
e		0.4	
E	0.905	0.935	0.965
E1		0.4	
f _D		0.272	
f _E		0.200	
ccc		0.075	

Figure 28. Flip Chip 6 package dimensions

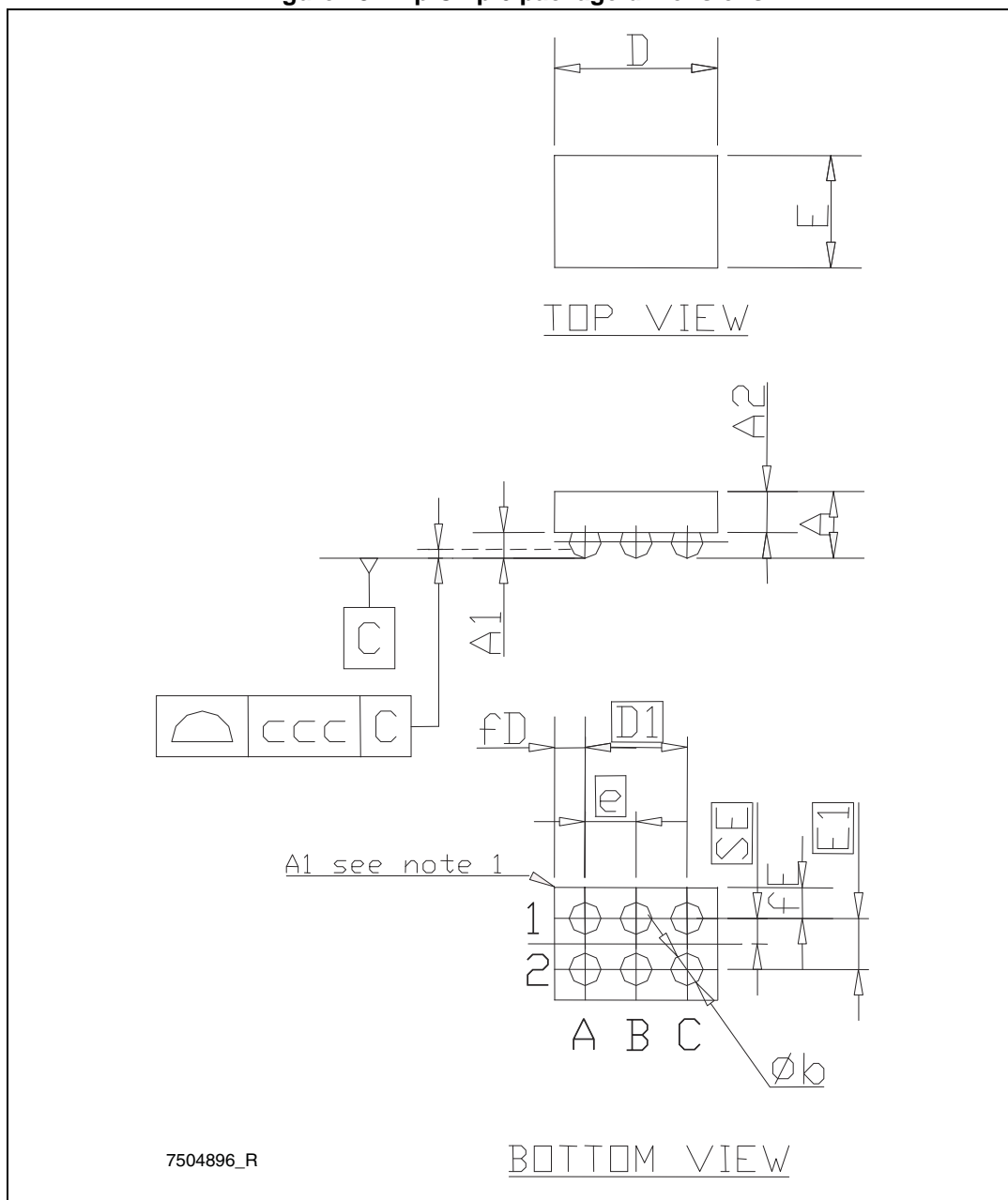
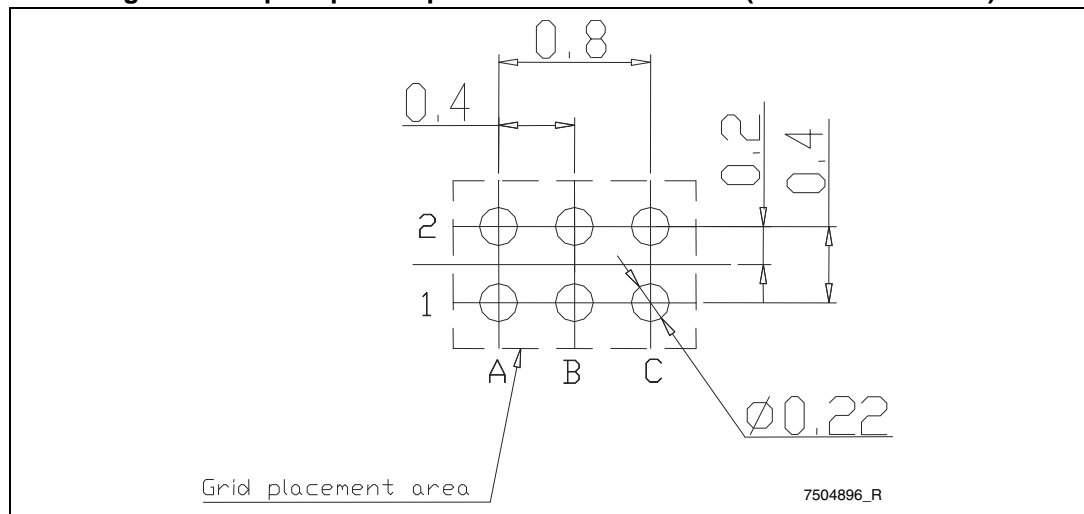
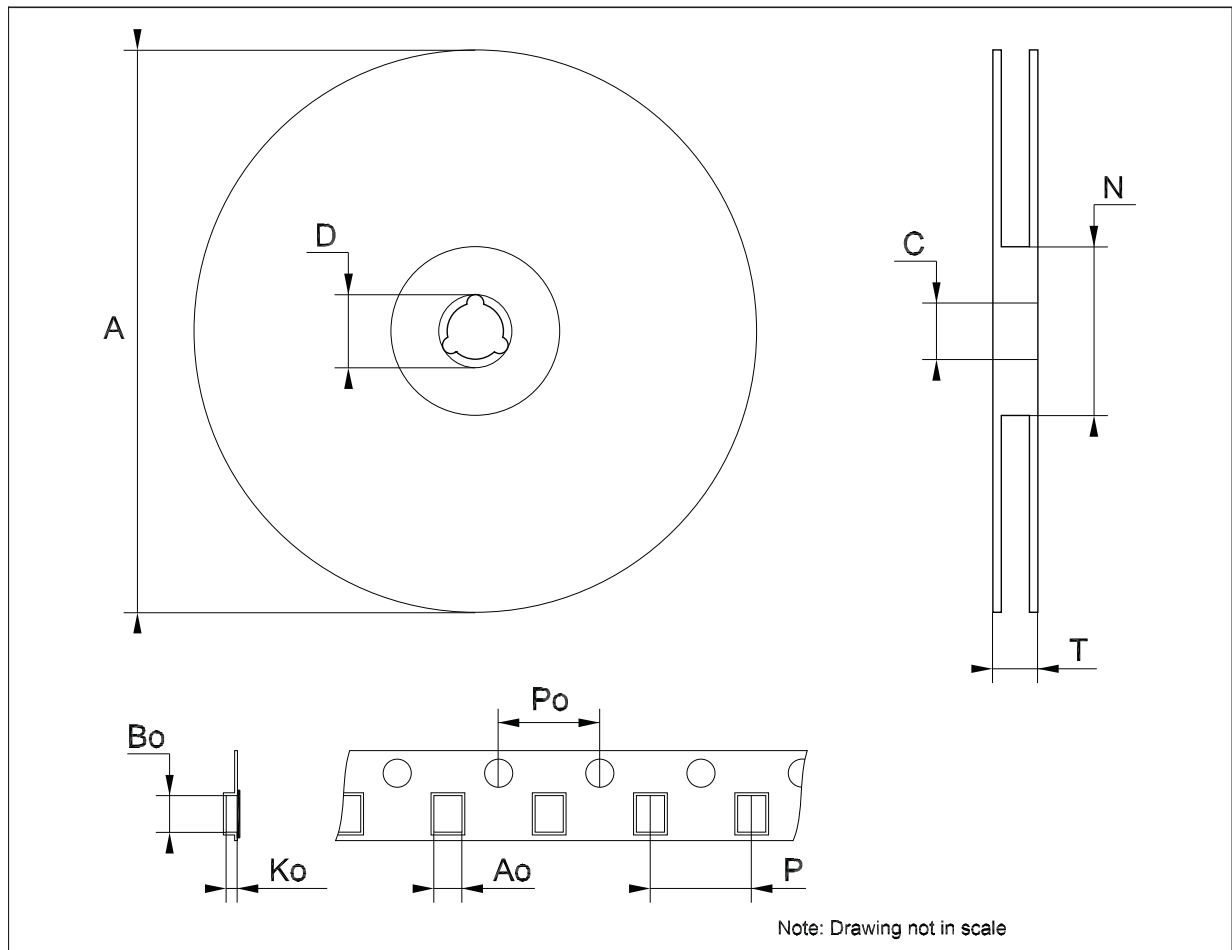

Figure 29. Flip Chip 6 footprint recommended data (dimensions in mm)



Tape & reel QFNxx/DFNxx (2x2 mm) mechanical data

Dim.	mm.			inch.		
	Min.	Typ.	Max.	Min.	Typ.	Max.
A			180			7.087
C	12.8		13.2	0.504		0.519
D	20.2			0.795		
N	60			2.362		
T			14.4			0.567
Ao	2.1	2.2	2.3	0.083	0.087	0.091
Bo	2.1	2.2	2.3	0.083	0.087	0.091
Ko	0.65	0.75	0.85	0.026	0.030	0.033
Po		4			0.157	
P		4			0.157	



Tape & reel Flip-Chip 6 mechanical data

Dim.	mm.		
	Min.	Typ.	Max.
A			180
C	12.8		13.2
D	20.2		
N	60		
T			14.4
Ao	1.01	1.06	1.11
Bo	1.26	1.31	1.36
Ko	0.61	0.66	0.71
Po	3.9		4.1
P	3.9		4.1

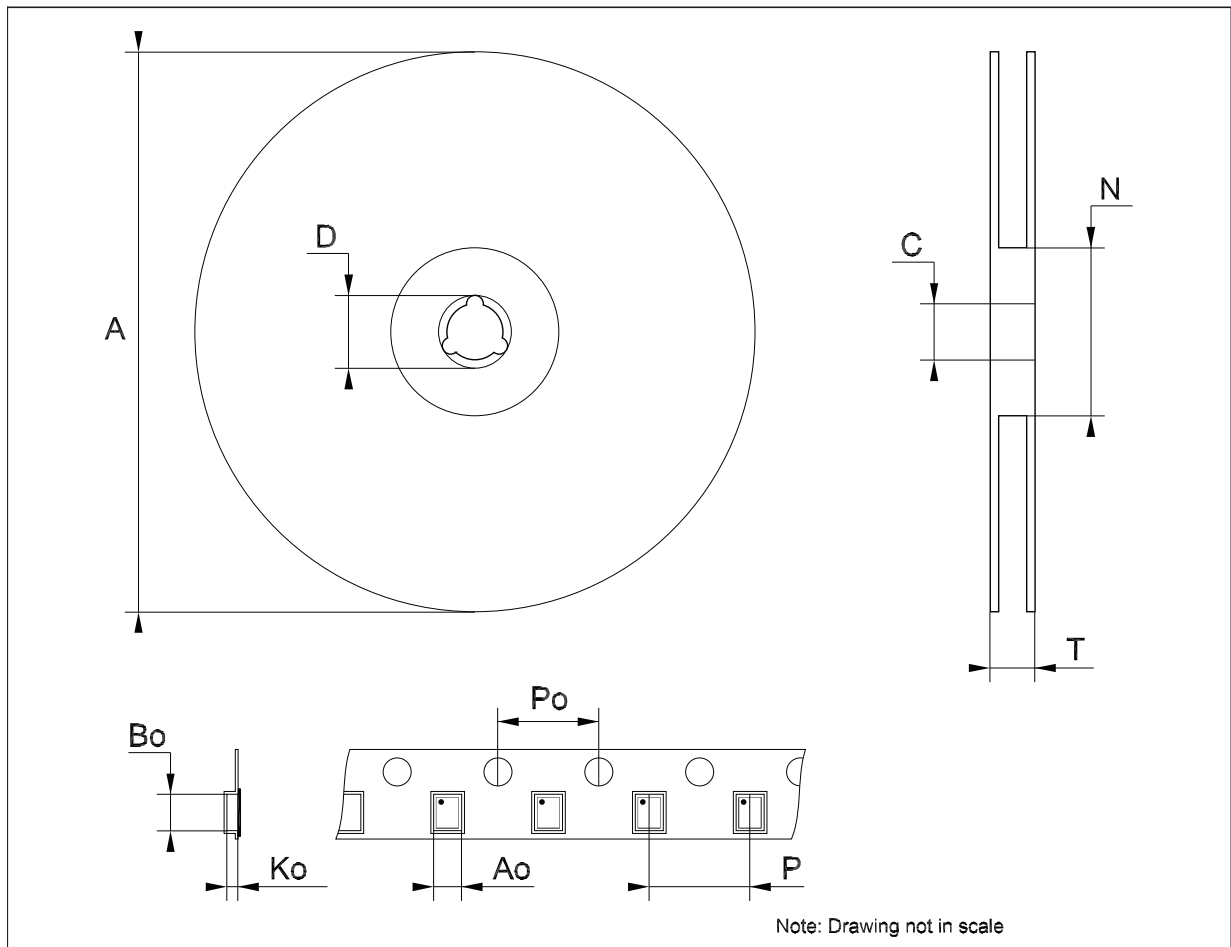

10 Different output voltage versions of the ST1S15 available on request

Options available on request:

- 0.8 V
- 1 V
- 1.05 V
- 1.2 V
- 1.25 V
- 1.5 V
- 1.8 V
- 1.85 V
- 1.875 V
- 2.5 V
- 3 V
- 3.3 V

11 Revision history

Table 11. Document revision history

Date	Revision	Changes
07-Jun-2012	1	First release.
04-Mar-2013	2	Modified: D1 and E1 values Table 10 on page 21 .
27-Aug-2013	3	Updated Table 1: Device summary on page 1 , Table 7: Electrical characteristics on page 6 , Section 9: Package mechanical data and Section 10: Different output voltage versions of the ST1S15 available on request . Minor text changes.

Please Read Carefully:

Information in this document is provided solely in connection with ST products. STMicroelectronics NV and its subsidiaries ("ST") reserve the right to make changes, corrections, modifications or improvements, to this document, and the products and services described herein at any time, without notice.

All ST products are sold pursuant to ST's terms and conditions of sale.

Purchasers are solely responsible for the choice, selection and use of the ST products and services described herein, and ST assumes no liability whatsoever relating to the choice, selection or use of the ST products and services described herein.

No license, express or implied, by estoppel or otherwise, to any intellectual property rights is granted under this document. If any part of this document refers to any third party products or services it shall not be deemed a license grant by ST for the use of such third party products or services, or any intellectual property contained therein or considered as a warranty covering the use in any manner whatsoever of such third party products or services or any intellectual property contained therein.

UNLESS OTHERWISE SET FORTH IN ST'S TERMS AND CONDITIONS OF SALE ST DISCLAIMS ANY EXPRESS OR IMPLIED WARRANTY WITH RESPECT TO THE USE AND/OR SALE OF ST PRODUCTS INCLUDING WITHOUT LIMITATION IMPLIED WARRANTIES OF MERCHANTABILITY, FITNESS FOR A PARTICULAR PURPOSE (AND THEIR EQUIVALENTS UNDER THE LAWS OF ANY JURISDICTION), OR INFRINGEMENT OF ANY PATENT, COPYRIGHT OR OTHER INTELLECTUAL PROPERTY RIGHT.

ST PRODUCTS ARE NOT AUTHORIZED FOR USE IN WEAPONS. NOR ARE ST PRODUCTS DESIGNED OR AUTHORIZED FOR USE IN: (A) SAFETY CRITICAL APPLICATIONS SUCH AS LIFE SUPPORTING, ACTIVE IMPLANTED DEVICES OR SYSTEMS WITH PRODUCT FUNCTIONAL SAFETY REQUIREMENTS; (B) AERONAUTIC APPLICATIONS; (C) AUTOMOTIVE APPLICATIONS OR ENVIRONMENTS, AND/OR (D) AEROSPACE APPLICATIONS OR ENVIRONMENTS. WHERE ST PRODUCTS ARE NOT DESIGNED FOR SUCH USE, THE PURCHASER SHALL USE PRODUCTS AT PURCHASER'S SOLE RISK, EVEN IF ST HAS BEEN INFORMED IN WRITING OF SUCH USAGE, UNLESS A PRODUCT IS EXPRESSLY DESIGNATED BY ST AS BEING INTENDED FOR "AUTOMOTIVE, AUTOMOTIVE SAFETY OR MEDICAL" INDUSTRY DOMAINS ACCORDING TO ST PRODUCT DESIGN SPECIFICATIONS. PRODUCTS FORMALLY ESCC, QML OR JAN QUALIFIED ARE DEEMED SUITABLE FOR USE IN AEROSPACE BY THE CORRESPONDING GOVERNMENTAL AGENCY.

Resale of ST products with provisions different from the statements and/or technical features set forth in this document shall immediately void any warranty granted by ST for the ST product or service described herein and shall not create or extend in any manner whatsoever, any liability of ST.

ST and the ST logo are trademarks or registered trademarks of ST in various countries.

Information in this document supersedes and replaces all information previously supplied.

The ST logo is a registered trademark of STMicroelectronics. All other names are the property of their respective owners.

© 2013 STMicroelectronics - All rights reserved

STMicroelectronics group of companies

Australia - Belgium - Brazil - Canada - China - Czech Republic - Finland - France - Germany - Hong Kong - India - Israel - Italy - Japan - Malaysia - Malta - Morocco - Philippines - Singapore - Spain - Sweden - Switzerland - United Kingdom - United States of America

www.st.com