

Multistage Ejector

Series ZL112-212

Energy-saving, large flow rate, 3 stage diffuser construction

Suction flow rate increased 250% and air consumption reduced 20% with 3 stage diffuser construction (Versus $\phi 1.3$, one stage model)

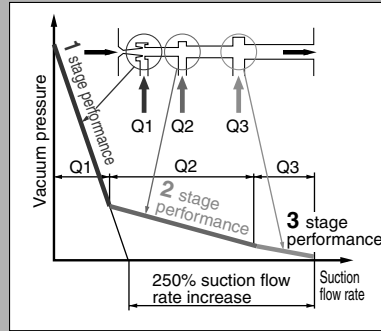

	Suction flow rate (ℓ/min (ANR))	Air consumption (ℓ/min (ANR))
ZL112	100	63
ZL212	200	126

Series ZL212

Diffusers stacked and integrated
Compact size and large flow rate
(Twice the flow rate of the ZL112)

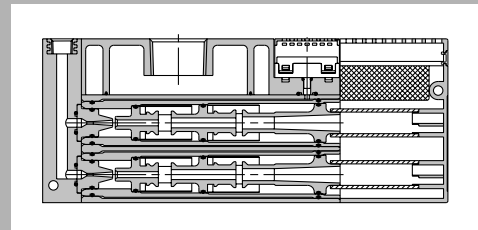

Vacuum pressure sensor

- With adaptor for vacuum
- With vacuum pressure gauge
- Digital vacuum pressure switch ZSE30A
 - Rated pressure range: 0.0 to -101.0 kPa
 - 3-step setting
 - Push
 - Adjust to set-value with Δ ∇ buttons.
 - Push
 Finish setting
 - Power-saving function
Power consumption is reduced by turning off the monitor. (Reduce power consumption by up to 20%.)

* For series ZSE30A, refer to the separate catalog (CAT.ES100-70) for details.

With One-touch fittings
Makes piping work easy (ZL112 only)

Exhaust port

- Built-in silencer
- Port exhaust

Other labels: Release valve, Supply valve, Release flow rate adjusting needle.

Series Variations

Series	Maximum suction flow rate (ℓ/min (ANR))	Air consumption (ℓ/min (ANR))	Vacuum pressure sensor option						
			Exhaust port		With valve		With digital vacuum pressure switch	Vacuum pressure gauge	Vacuum adaptor
			Built-in silencer	Port exhaust	With supply and release valves	With supply valve	ZSE30A		
ZL112	100	63	●	●	●	●	●	●	●
ZL212	200	126	●	●	●	●	●	●	●

- ZA
- ZX
- ZR
- ZM
- ZMA
- ZQ
- ZH
- ZU
- ZL
- ZY□
- ZF□
- ZP□
- SP
- ZCUK
- AMJ
- AMV
- AEP
- HEP
- Related Equipment

Ejector Specifications

Standard



With valve



With vacuum pressure gauge



Adapter



Port exhaust



Model	ZL112
Nozzle diameter	1.2 mm
Maximum suction flow rate	100 ℓ/min (ANR)
Air consumption	63 ℓ/min (ANR)
Maximum vacuum pressure	-84 kPa
Maximum operating pressure	0.7 MPa
Supply pressure range	0.2 to 0.5 MPa
Standard supply pressure	0.4 MPa
Operating temperature range	5 to 50°C

Supply/Release Valve Specifications

Part no.	SYJ514-□□□□
Type of valve actuation	N.C.
Fluid	Air
Operating pressure range	Internal pilot type 0.15 to 0.7 Mpa
Ambient and fluid temperature	-10°C to 50°C (No freezing)
Response time (For 0.5 MPa) ⁽¹⁾	25 ms or less
Maximum operating frequency	5 Hz
Manual override	Non-locking push type/Locking slotted type
Pilot exhaust type	Pilot valve individual exhaust, Main valve/Pilot valve common exhaust
Lubrication	Not required
Mounting position	Unrestricted
Impact/Vibration resistance ⁽²⁾	150/30 m/s ²
Enclosure	Dust proof

Note 1) Based on JIS B 8374-1981 dynamic performance test. (coil temperature 20°C, at rated voltage, without surge voltage suppressor)

Note 2) Impact resistance: No malfunction when tested with a drop tester in the axial direction and at a right angle to the main valve and armature, one time each in both energized and deenergized states. (initial value)

Vibration resistance: No malfunction when tested with one sweep of 45 to 2000 Hz in the axial direction and at a right angle to the main valve and armature, one time each in both energized and deenergized states. (initial value)

Note 3) Refer to "Best Pneumatics No. 1" for details on valves.

Option Specifications

Vacuum Pressure Gauge Specifications

Part no.	GZ30S
Fluid	Air
Pressure range	-100 to 100 kPa
Scale range (Angular)	230°
Accuracy	±3% F.S. (Full span)
Class	Class 3
Operating temperature range	0 to 50°C
Material	Housing: Polycarbonate/ABS resin

JIS Symbol

Standard

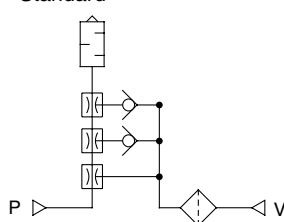

Mass

ZL112 (Basic)	450 g
Port exhaust	+110 g
Digital pressure switch for vacuum (Excluding lead wire)	+43 g
Digital pressure switch for vacuum (Including 3 cores lead wire)	+81 g
Digital pressure switch for vacuum (Including 4 cores lead wire)	+85 g
Valve (per 1 pc.)	+45 g

ZA

ZX

ZR

ZM

ZMA

ZQ

ZH

ZU

ZL

ZY□

ZF□

ZP□

SP

ZCUK

AMJ

AMV

AEP

HEP

Related Equipment

Series ZL112

Vacuum Pressure Switch Unit/Digital Pressure Switch for Vacuum: ZSE30A-00-□-□□□-X505



How to Order

ZSE30A - 00 - □ - □ □ □ - X505

Output specifications

Symbol	Output		Analog output	
	Type	Point	Voltage	Current
N	NPN	1	—	—
P	PNP	1	—	—
A	NPN	2	—	—
B	PNP	2	—	—
C	NPN	1	○	—
D	NPN	1	—	○
E	PNP	1	○	—
F	PNP	1	—	○

• Option 2 (Operating manual specifications)

Nil	Operating manual (Leaflet)
Y	Without operating manual

• Option 1 (Connector/Lead wire specifications)

Nil	Without lead wire
L	Lead wire with connector (Length 2 m)

• Display unit

Nil	With unit display switching function
M	Fixed SI unit
P	With unit display switching function (Initial value psi)

Specifications

Rated pressure range	0.0 to -101.0 kPa		
Set pressure range	10.0 to -105.0 kPa		
Withstand pressure	500 kPa		
Minimum unit setting	0.1 kPa		
Applicable fluid	Air, Non-corrosive gas, Non-flammable gas		
Power supply voltage	12 to 24 VDC ±10% (with power supply polarity protection)		
Current consumption	40 mA (at no load)		
Switch output	NPN or PNP open collector 1 output NPN or PNP open collector 2 outputs (selectable)		
Maximum load current	80 mA		
Maximum applied voltage	28 V (at NPN output)		
Residual voltage	1 V or less (with load current of 80 mA)		
Response time	2.5 ms or less (with anti-chattering function: 20, 100, 500, 1000, 2000 ms)		
Short circuit protection	Yes		
Repeatability	±0.2% F.S. ±1 digit		
Hysteresis	Hysteresis mode	Variable (0 to variable)	
	Window comparator mode		
Analog output	Voltage output	Note 1) Output voltage (Rated pressure range)	1 to 5 V ±2.5% F.S.
		Linearity	±1% F.S. or less
	Current output	Note 2) Output current (Rated pressure range)	4 to 20 mA ±2.5% F.S.
		Linearity	±1% F.S. or less
Load impedance	Maximum load impedance: Power supply voltage 12 V: 300 Ω, Power supply voltage 24 V: 600 Ω Minimum load impedance: 50 Ω		
Display	4-digit, 7-segment, 2-color LCD (Red/Green) Sampling cycle: 5 times/sec.		
Display accuracy	±2% F.S. ±1 digit (Ambient temperature of 25°C)		
Indicator light	Lights up when switch output is turned ON. (OUT1: Green, OUT2: Red)		
Environment resistance	Enclosure	IP40	
	Operating temperature range	Operating: 0 to 50°C, Stored: -10 to 60°C (No freezing or condensation)	
	Operating humidity range	Operating/Stored: 35 to 85% RH (No condensation)	
	Withstand voltage	1000 VAC for 1 minute between live parts and case	
	Insulation resistance	50 MΩ or more between live parts and case (at 500 VDC Mega)	
	Vibration resistance	10 to 150 Hz at whichever is smaller of 1.5 mm amplitude or 20 m/s ² acceleration, in X, Y, Z directions, for 2 hours each	
Impact resistance	100 m/s ² , in X, Y, Z directions, for 2 hours each		
Temperature characteristics	±2% F.S. (Based on 25°C)		
Lead wire	Oilproof heavy-duty vinyl cable, 3 cores ø3.5, 2 m 4 cores Conductor area: 0.15 mm ² (AWG26) Insulator O.D.: 1.0 mm		
Standards	CE Marking, UL/CSA, RoHS compliance		

Note 1) When analog voltage output is selected, analog current output cannot be used together.

Note 2) When analog current output is selected, analog voltage output cannot be used together.

Exhaust Characteristics/Flow Characteristics/Time to Reach Vacuum

ZL112

Exhaust Characteristics

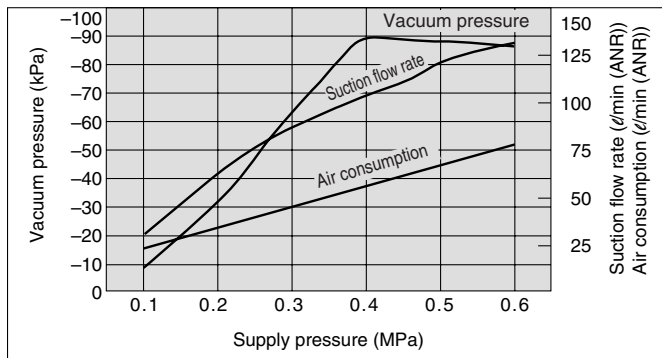

Flow Characteristics

Supply pressure: 0.4 MPa

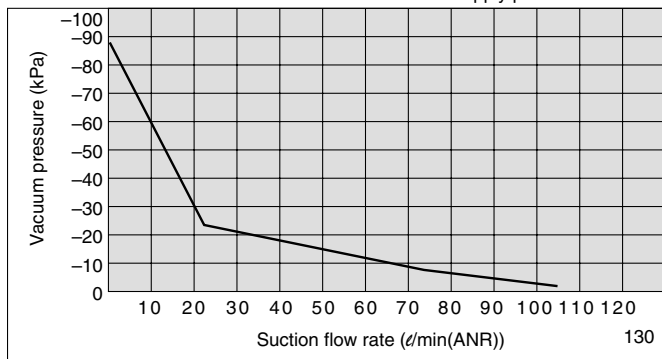

Time to Reach Vacuum

Tank capacity: 1ℓ
Supply pressure: 0.4 MPa

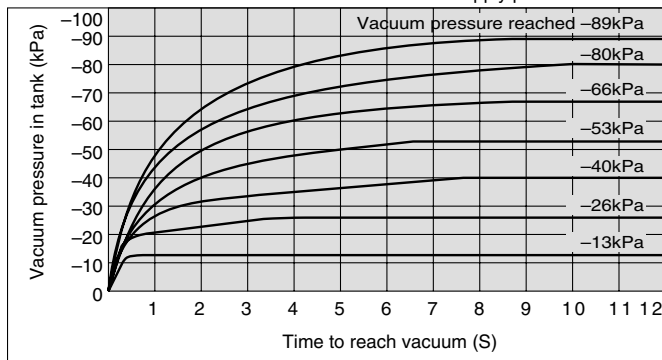

<How to Read the Graph>

The graphics indicate the time required to reach a vacuum pressure determined by adsorption conditions for workpieces, etc., starting from atmospheric pressure in a 1ℓ sealed tank. Approximately 8.8 seconds are necessary to attain a vacuum pressure of -89 kPa.

ZL212

Exhaust Characteristics

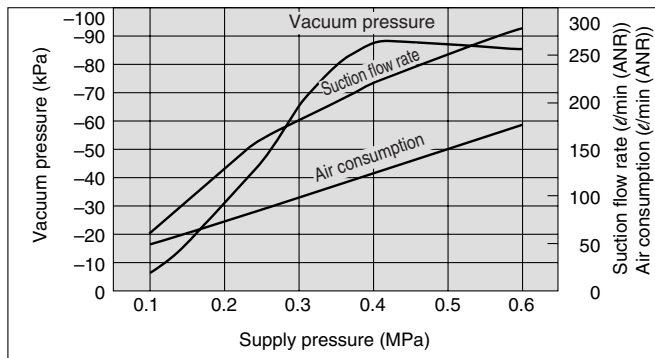

Flow Characteristics

Supply pressure: 0.4 MPa

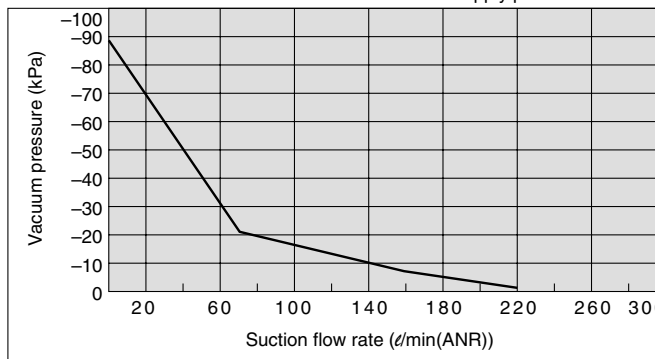

Time to Reach Vacuum

Tank capacity: 1ℓ
Supply pressure: 0.4 MPa

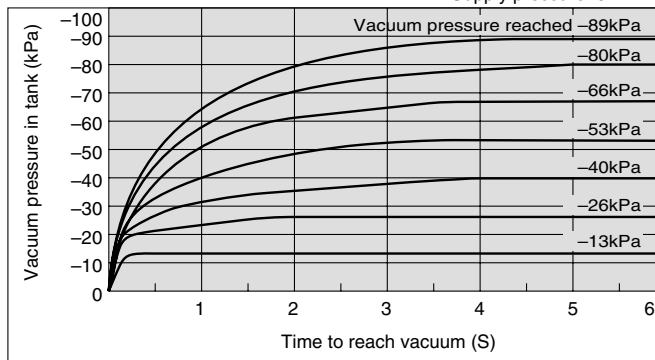

<How to Read the Graph>

The flow characteristics indicate the relationship between the vacuum pressure and the suction flow rate of the ejector, and show that when the suction flow rate changes the vacuum pressure also changes. In general, this indicates the relationship at the ejector's standard operating pressure. In the graph, Pmax indicates the maximum vacuum pressure, and Qmax indicates the maximum suction flow rate. These are the values that are published as specifications in catalogs, etc. Changes in vacuum pressure are explained below.

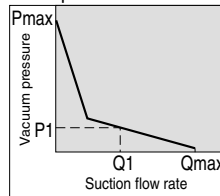

1. If the ejector's suction port is closed and sealed tight, the suction flow rate becomes "0" and the vacuum pressure increases to the maximum (Pmax).
2. If the suction port is opened and air is allowed to flow (the air leaks), the suction flow rate increases and the vacuum pressure decreases. (the condition of P1 and Q1)
3. If the suction port is opened completely, the suction flow rate increases to the maximum (Qmax), while the vacuum pressure then drops almost to "0" (atmospheric pressure). When adsorbing work pieces which are permeable or subject to leakage, etc., caution is required as the vacuum pressure will not be very high.

ZA

ZX

ZR

ZM

ZMA

ZQ

ZH

ZU

ZL

ZY□

ZF□

ZP□

SP

ZCUK

AMJ

AMV

AEP

HEP

Related Equipment

Series ZL112

Construction

Without valve

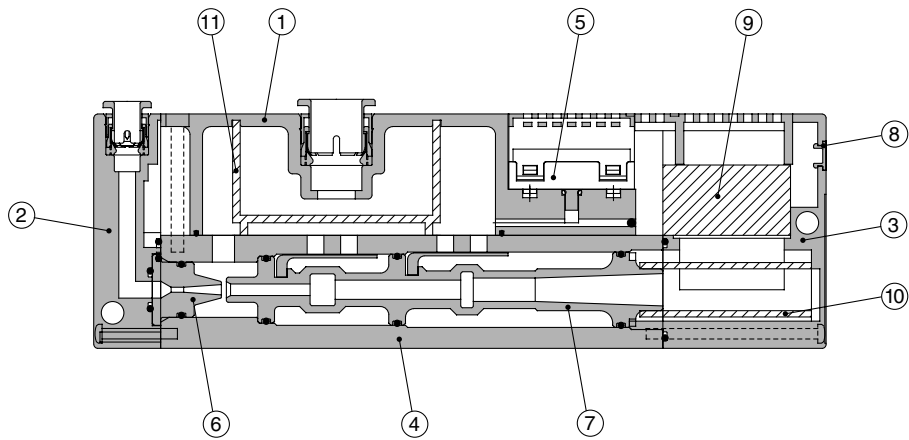

With valve

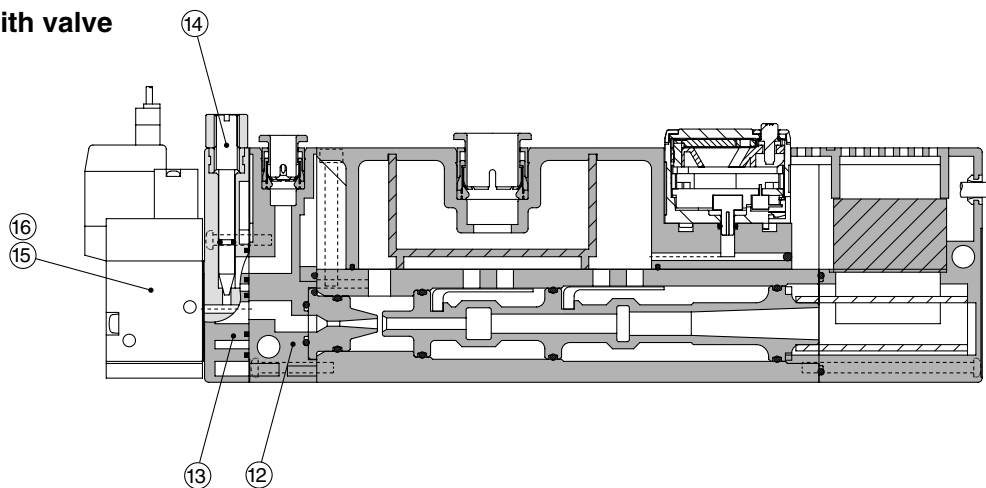

Comonent Parts

No.	Description	Part no.	Note
1	Suction cover		
2	Front cover		Without valve
3	End cover		
4	Body		
5	Vacuum sensor unit		
6	Nozzle		
7	Diffuser		
8	Detent plug		Other than vacuum switch
	Lead wire cover		Vacuum switch specifications
12	Front cover B		With valve
13	Valve plate		With valve
14	Needle		With valve
15	Supply valve (N.C.)	SYJ514-□□□	With valve
16	Release valve (N.C.)	SYJ514-□□□	With valve

Replacement Parts

No.	Description	Material	Part no.
9	Sound absorbing material B	PVF	ZL112-SP01 (Set no. for 9, 10 & 11)
10	Sound absorbing material A	PVF	
11	Suction filter	PE	

Series ZL112

Dimensions: Series ZL112 (With Valve)

With supply valve and release valve

ZL112-K1□L□□-D□□□

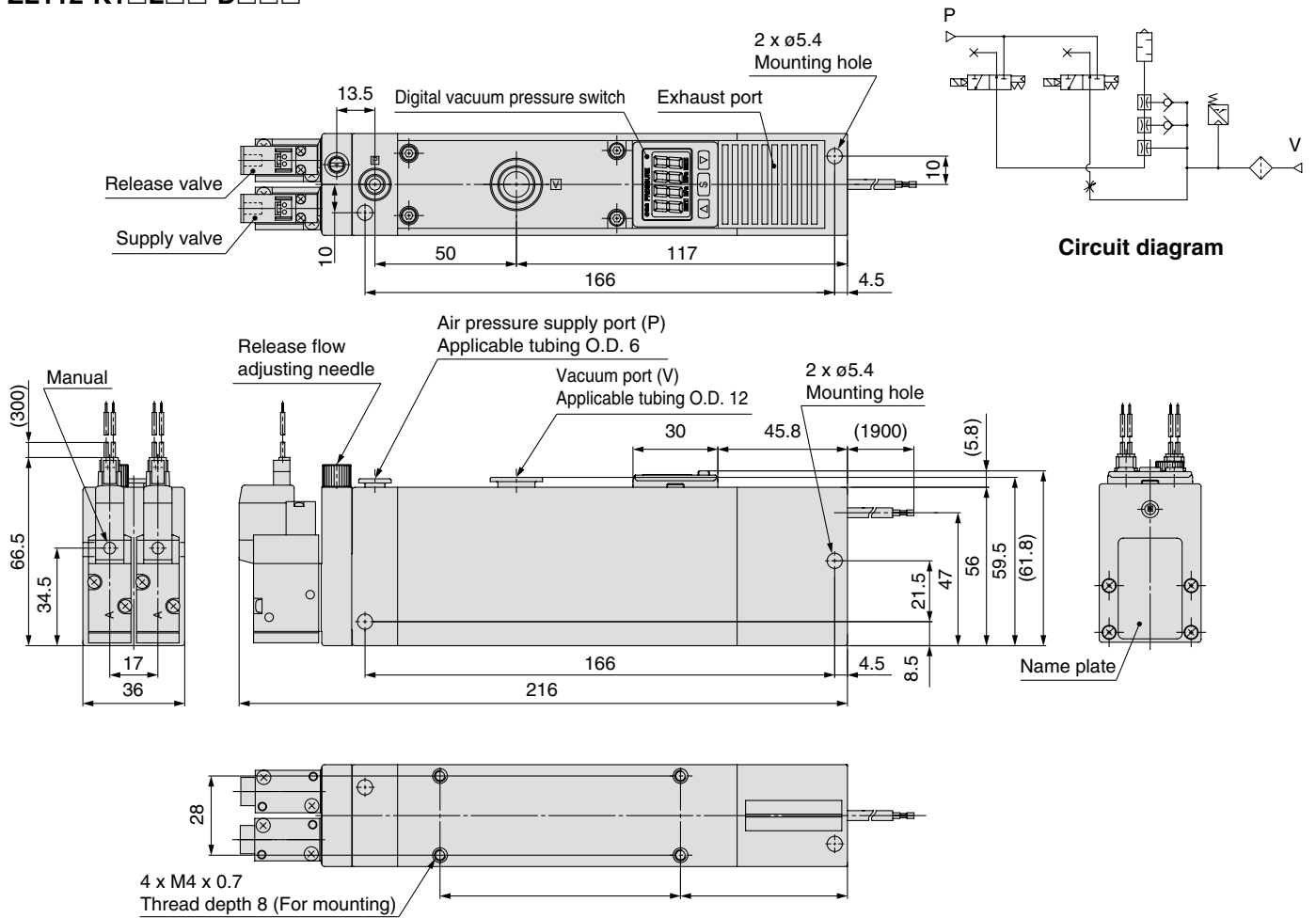

With supply valve

ZL112-K2□L□□-D□□□

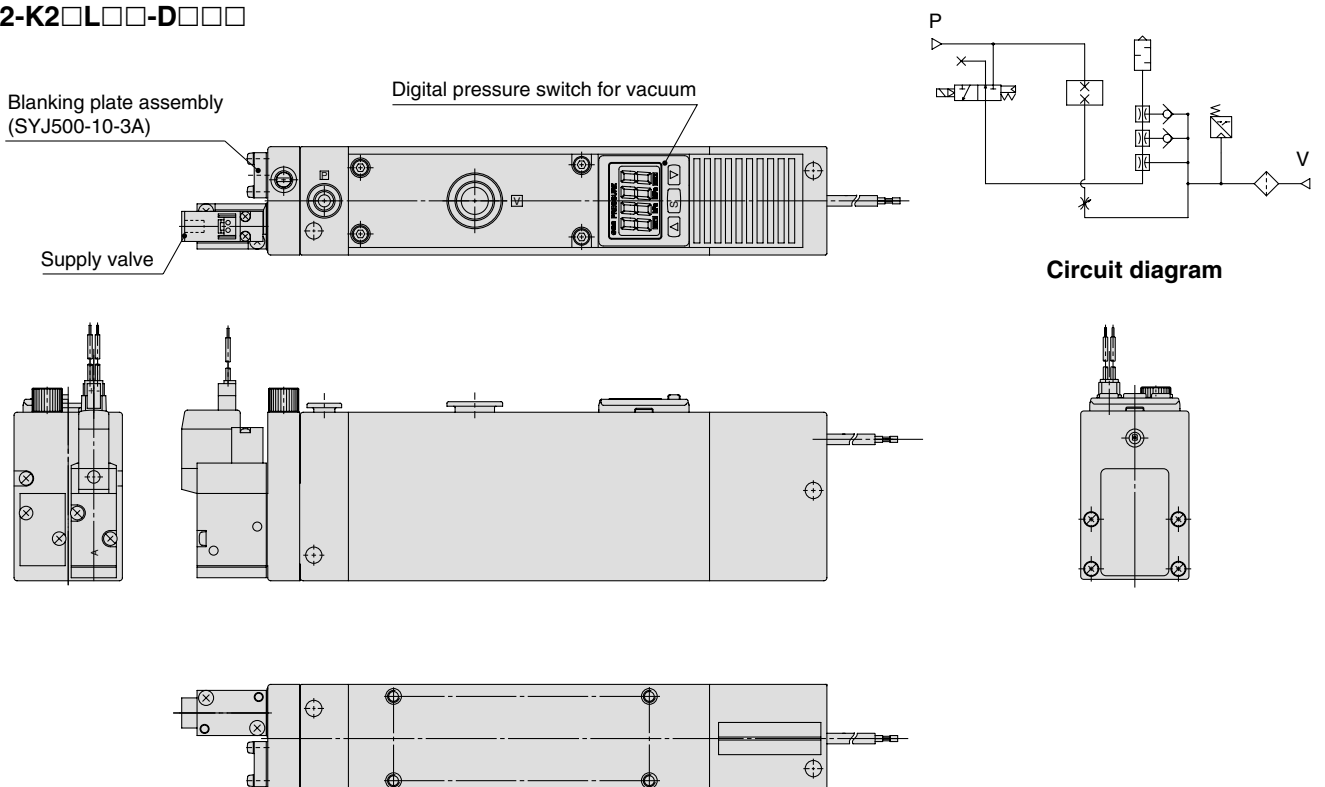

Multistage Ejector Series ZL212

Standard



With vacuum pressure gauge



With digital vacuum pressure switch



With adaptor



Port exhaust



How to Order

ZL2 12 □ - □ □ □ □

Nozzle diameter
12 1.2 mm

Exhaust specifications
Nil Built-in silencer
P Port exhaust

Vacuum pressure sensor
Nil None
GN Vacuum port adaptor Rc 1/8
G Vacuum pressure gauge
D Digital pressure switch for vacuum

Lead wire specifications

(Applicable only when the vacuum pressure sensor specification is "D" for digital pressure switch for vacuum)

L Lead wire with connector (Length 2 m)

Unit specifications

(Applicable only when the vacuum pressure sensor specification is "D" for digital pressure switch for vacuum)

Nil	With unit switching function
M	SI unit only
P	With unit switching function (Initial value psi)

Note 1) W/ unit switching function is not permitted to sell for the domestic use in Japan, because the new Weight and Measure Act has been implemented since October '99.

Note 2) Fixed unit: kPa

Output specifications

(Applicable only when the vacuum pressure sensor specification is "D" for digital pressure switch for vacuum)

N	NPN open collector 1 output
P	PNP open collector 1 output
A	NPN open collector 2 outputs
B	PNP open collector 2 outputs
C	NPN open collector 1 output + Analog voltage output
D	NPN open collector 1 output + Analog current output
E	PNP open collector 1 output + Analog voltage output
F	PNP open collector 1 output + Analog current output

Ejector Specifications

Model	ZL212
Nozzle diameter	ø1.2 mm x 2
Maximum suction flow rate	200 ℓ/min (ANR)
Air consumption	126 ℓ/min (ANR)
Maximum vacuum pressure	-84 kPa
Maximum operating pressure	0.7 MPa
Supply pressure range	0.2 to 0.5 MPa
Standard supply pressure	0.4 MPa
Operating temperature range	5 to 50°C

JIS Symbol
Standard

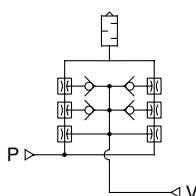

Mass

ZL212	700 g
Port exhaust	+300 g
Digital pressure switch for vacuum (Excluding lead wire)	+43 g
Digital pressure switch for vacuum (Including 3 cores lead wire)	+81 g
Digital pressure switch for vacuum (Including 4 cores lead wire)	+85 g
Valve (per 1 pc.)	+45 g

ZA

ZX

ZR

ZM

ZMA

ZQ

ZH

ZU

ZL

ZY□

ZF□

ZP□

SP

ZCUK

AMJ

AMV

AEP

HEP

Related Equipment



Made to Order
(Refer to page 1078 for details.)

Series ZL212

Construction

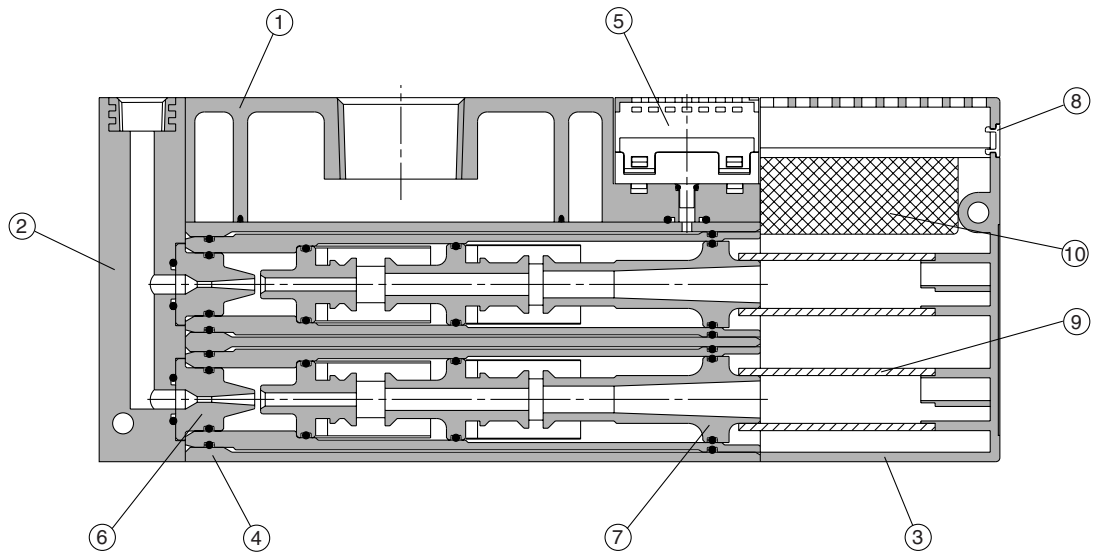

Component Parts

No.	Description	Note
1	Suction cover	
2	Front cover A	
3	End plate	
4	Body	
5	Vacuum sensor unit	
6	Nozzle	
7	Diffuser	
8	Detent plug	Other than vacuum switch
	Lead wire cover	Vacuum switch specifications

Replacement Parts

No.	Description	Material	Part no.
9	Sound absorbing material A	PVF	ZL212-SP01
10	Sound absorbing material	PVF	(Set no. for 9 & 10)

Dimensions: Series ZL212

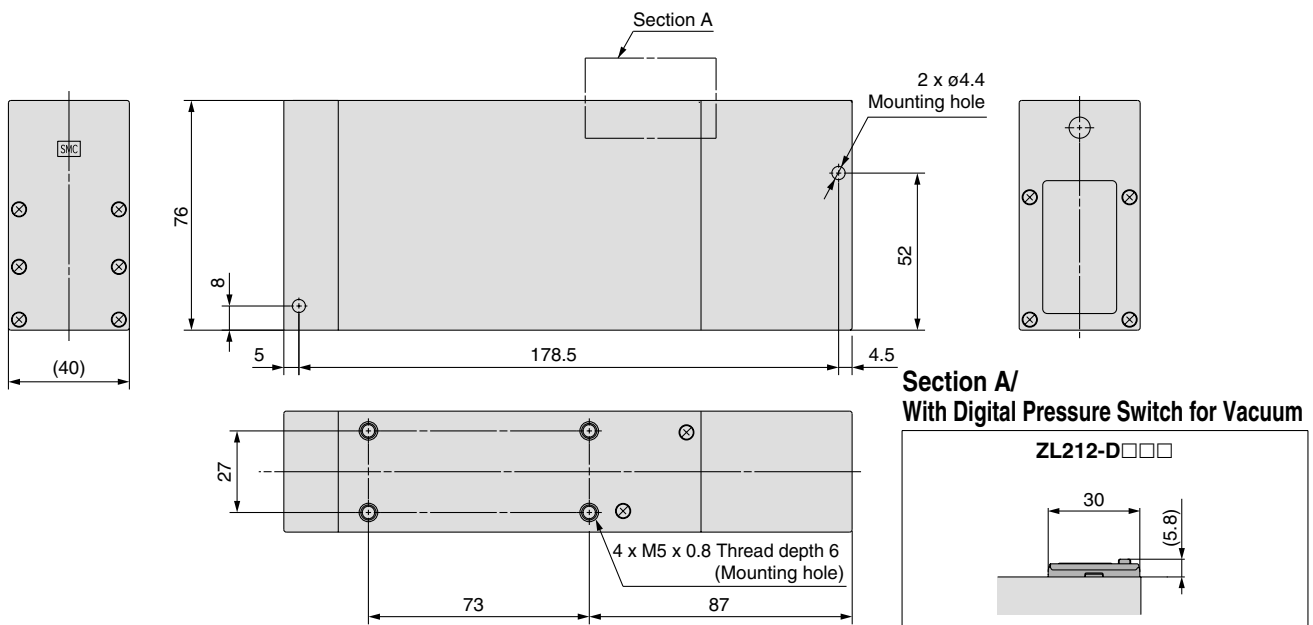
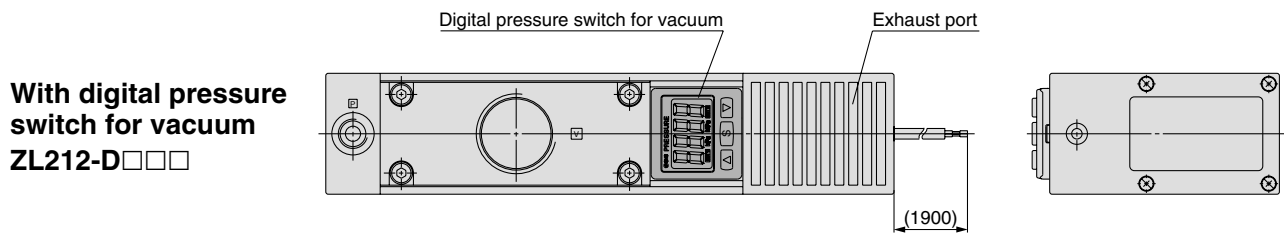
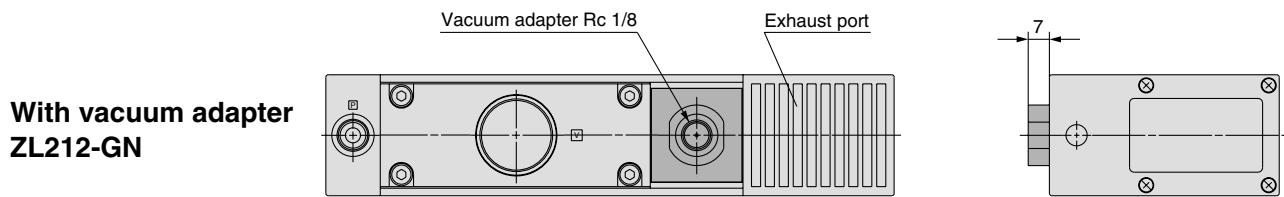
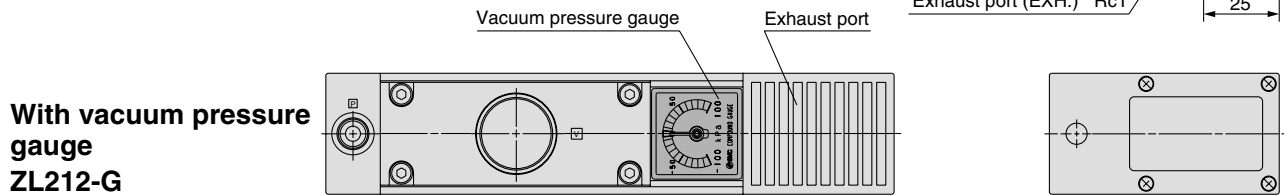
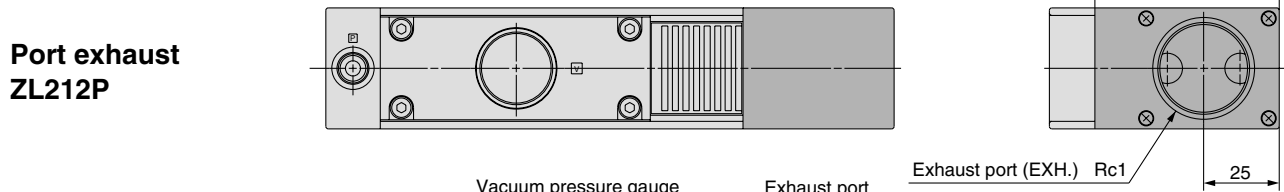
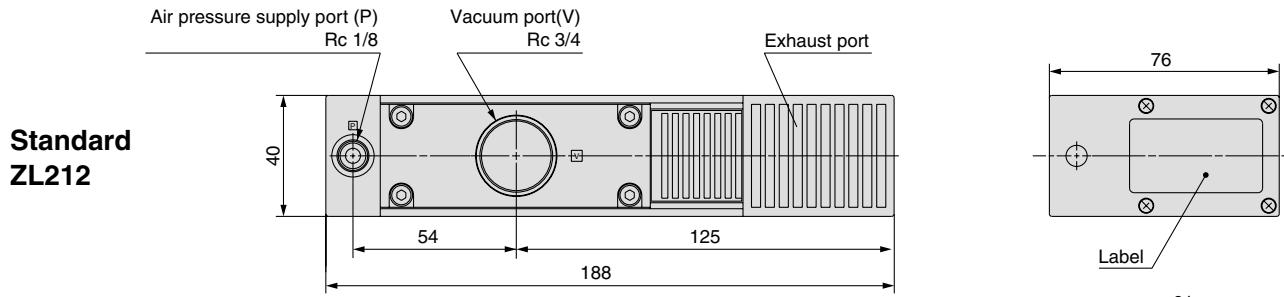

- ZA
- ZX
- ZR
- ZM
- ZMA
- ZQ
- ZH
- ZU
- ZL**
- ZY□
- ZF□
- ZP□
- SP
- ZCUK
- AMJ
- AMV
- AEP
- HEP
- Related Equipment

Series ZL

Made to Order Specifications



Please contact SMC for detailed specifications, dimensions and delivery.

1 With Supply and Release Valves

ZL212 Valve Voltage Electrical entry — Vacuum pressure switch Electrical entry — X132

With supply and release valves

ZL212 type with supply and release valves



Dimensions

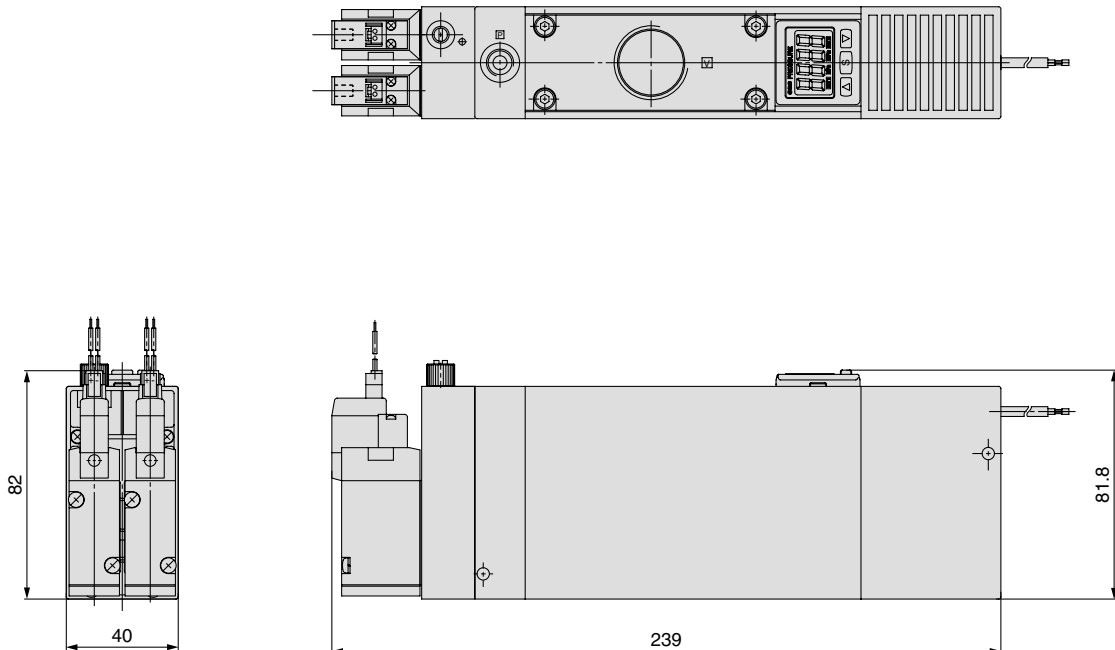



Series ZL Specific Product Precautions

Be sure to read before handling.

Refer to front matters 38 and 39 for Safety Instructions and pages 844 to 846 for Vacuum Equipment Precautions.

Operation of Ejector Valves

Caution

1. When the air supply valve is turned ON, vacuum is generated by the flow of compressed air from the nozzle to the diffuser.

When the vacuum release valve is turned ON, the vacuum is quickly released as air passes through the release flow adjustment needle and flows to the vacuum port.

Operating Environment

Caution

1. Avoid use exposed to direct sunlight.

Solenoid Valves (Series ZL112)

Caution

1. For specific product precautions on solenoid valves, refer to the solenoid valve (Series SYJ500) catalog.

ZA

ZX

ZR

ZM

ZMA

ZQ

ZH

ZU

ZL

ZY□

ZF□

ZP□

SP

ZCUK

AMJ

AMV

AEP

HEP

Related
Equipment