

## MKDS 1/12-3,5

Order No.: 1751345

The figure shows a 10-position version of the product

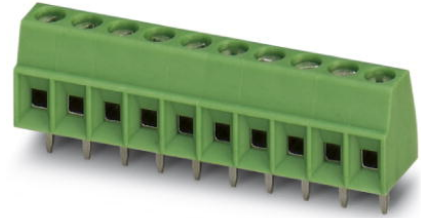

Printed circuit terminal block, nominal current: 10 A, rated voltage: 160 V, pitch: 3.5 mm, no. of positions: 12, mounting: Soldering, type of connection: Screw connection, connection direction from the conductor to the PCB: 0°

### Commercial data

EAN	4017918103903
Pack	50 Pcs.
Customs tariff	85369010
Weight/Piece	0.0062 KG
Catalog page information	Page 49 (CC-2007)

### Product notes

WEEE/RoHS-compliant since:  
01/01/2003



<http://www.download.phoenixcontact.com>  
Please note that the data given here has been taken from the online catalog. For comprehensive information and data, please refer to the user documentation. The General Terms and Conditions of Use apply to Internet downloads.

### Technical data

#### Dimensions / positions

Pitch	3.5 mm
Dimension a	38.5 mm
Number of positions	12

Pin dimensions	0,5 x 0,9 mm
Hole diameter	1.1 mm
Screw thread	M 2
Tightening torque, min	0.22 Nm

#### Technical data

Insulating material group	I
Rated surge voltage (III/3)	2.5 kV
Rated surge voltage (III/2)	2.5 kV
Rated surge voltage (II/2)	2.5 kV
Rated voltage (III/2)	200 V
Rated voltage (II/2)	400 V
Connection in acc. with standard	EN-VDE
Nominal current $I_N$	10 A
Nominal voltage $U_N$	160 V
Nominal cross section	1 mm <sup>2</sup>
Maximum load current	12 A
Insulating material	PA
Inflammability class acc. to UL 94	V0
Stripping length	5 mm

#### Connection data

Conductor cross section solid min.	0.14 mm <sup>2</sup>
Conductor cross section solid max.	1.5 mm <sup>2</sup>
Conductor cross section stranded min.	0.14 mm <sup>2</sup>
Conductor cross section stranded max.	1 mm <sup>2</sup>
Conductor cross section stranded, with ferrule without plastic sleeve min.	0.25 mm <sup>2</sup>
Conductor cross section stranded, with ferrule without plastic sleeve max.	0.5 mm <sup>2</sup>
Conductor cross section stranded, with ferrule with plastic sleeve min.	0.25 mm <sup>2</sup>
Conductor cross section stranded, with ferrule with plastic sleeve max.	0.5 mm <sup>2</sup>
Conductor cross section AWG/kcmil min.	26
Conductor cross section AWG/kcmil max	16
2 conductors with same cross section, solid min.	0.14 mm <sup>2</sup>

2 conductors with same cross section, solid max.	0.5 mm <sup>2</sup>
2 conductors with same cross section, stranded min.	0.14 mm <sup>2</sup>
2 conductors with same cross section, stranded max.	0.2 mm <sup>2</sup>

## Certificates / Approvals

### Approval logo



#### CSA

Nominal voltage U <sub>N</sub>	300 V
Nominal current I <sub>N</sub>	10 A
AWG/kcmil	28-16

#### CUL

Nominal voltage U <sub>N</sub>	300 V
Nominal current I <sub>N</sub>	10 A
AWG/kcmil	30-16

#### UL

Nominal voltage U <sub>N</sub>	300 V
Nominal current I <sub>N</sub>	10 A
AWG/kcmil	30-16
Certification	CB, CCA, CSA, CUL, GOST, SEV, UL

## Accessories

Item	Designation	Description
------	-------------	-------------

#### Marking

1051993	B-STIFT	Marker pen, for manual labeling of unprinted Zack strips, smear-proof and waterproof, line thickness 0.5 mm
0804073	SK 3,5/2,8:FORTL.ZAHLEN	Marker card, printed horizontally, self-adhesive, 10-section marker strip, 14 identical decades marked 1-10, 11-20 etc. up to 91-100, sufficient for 140 terminal blocks

0805030	SK 3,5/2,8:SO	Marker card, special printing, self-adhesive, labeled acc. to customer requirements, 14 identical marker strips per card, max. 25-position labeling per strip, color: White
0803883	SK U/2,8 WH:UNBEDRUCKT	Unprinted marker cards, DIN A4 format, pitch as desired, self-adhesive, with 50 stamped marker strips, 185 mm strip length, can be labeled with the CMS system or manually with the M-PEN
<b>Tools</b>		
1205037	SZS 0,4X2,5	Screwdriver, bladed, matches all screw terminal blocks up to 1.5 mm <sup>2</sup> connection cross section, blade: 0.4 x 2.5 mm

## Drawings

Drilling diagram

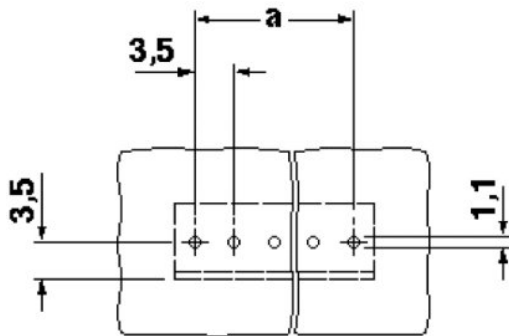

Dimensioned drawing

