

DETAILS

Product Number	F13838_ANGELINA-XW
Family	ANGELINA
Type	Reflector
Color	white
Diameter	82 mm
Height	31 mm
Style	round
Optic Material	HRPC
Holder Material	
Fastening	
Status	ready
ROHS Compliant	Yes
Date Updated	30/10/2014



OPTICAL PROPERTIES

LED	Viewing Angle	Light Beam	Efficiency	cd/lm	Connector
J216A/J130B/J108B/J048Z	88 deg	Wide	92 %	0.530	IDEAL: 50-2103NC + Angela(50-2100AN)
PrevaLED Core AC (LEP-2000)	89 deg	Wide	94 %	0.510	TE: Z50 Optic Clip part nr. 2213194-1
CLL03x/CLU034	89 deg	Wide	94 %	0.500	IDEAL: 50-2103CT + Angela(50-2100AN)
CLU720	89 deg	Wide	94 %	0.540	IDEAL: 50-2103CT + Angela(50-2100AN)
Fortimo SLM 4500 G3	90 deg	Wide	94 %	0.490	TE: Z50 Optic Clip part nr. 2213194-1
STARK SLE G2 LES26	90 deg	Wide	94 %	0.500	TE: Z50 Optic Clip part nr. 2213194-1
STARK SLE G2 LES23	90 deg	Wide	94 %	0.500	TE: Z50 Optic Clip part nr. 2213194-1
PrevaLED Core AC (LEP-800)	90 deg	Wide	94 %	0.520	TE: Z50 Optic Clip part nr. 2213194-1
PrevaLED Core Z4 LES19	90 deg	Wide	94 %	0.510	TE: Z50 Optic Clip part nr. 2213194-1
Fortimo LED SLM L19 G4 standard	90 deg	Wide	93 %	0.490	TE: Z50 Optic Clip part nr. 2213194-1
SLE G4 LES23 H	90 deg	Wide	94 %	0.500	TE: Z50 Optic Clip part nr. 2213194-1
LUXEON K16	90 deg	Wide	94 %	0.530	BJB: Solderless Connector 47.319.2070
CXA/B 3590	90 deg	Wide	94 %	0.480	IDEAL: 50-2303CR + Angela(50-2300AN)
Fortimo SLM 2000 G3	91 deg	Wide	94 %	0.517	TE: Z50 Optic Clip part nr. 2213194-1
Fortimo SLM 3000 G3	91 deg	Wide	94 %	0.489	TE: Z50 Optic Clip part nr. 2213194-1
STARK SLE G2 LES19	91 deg	Wide	94 %	0.500	TE: Z50 Optic Clip part nr. 2213194-1
Soleriq S19	91 deg	Wide	94 %	0.500	TE: part nr. 2213407-2 + Z50 Optic Clip part nr. 2213194-1
Fortimo LED SLM L15 G4 standard	91 deg	Wide	94 %	0.490	TE: Z50 Optic Clip part nr. 2213194-1
SLE G4 LES19 H	91 deg	Wide	93 %	0.490	TE: Z50 Optic Clip part nr. 2213194-1
LUXEON K12	92 deg	Wide	94 %	0.520	TE: part nr. 2213134-2 + Z50 Optic Clip part nr. 2213194-1
Mega Zenigata (GW6DME)	92 deg	Wide	94 %	0.500	TE: part nr. 2213130-2 + Z50 Optic Clip part nr. 2213194-1
WU-M-486	92 deg	Wide	94 %	0.470	TE: Z50 Optic Clip part nr. 2213194-1
Soleriq P13	92 deg	Wide	94 %	0.490	TE: part nr. 2213401-2 + Z50 Optic Clip part nr. 2213194-1
Soleriq S13	92 deg	Wide	94 %	0.500	TE: part nr. 2213401-2 + Z50 Optic Clip part nr. 2213194-1
L121A/L060B/L024Z	92 deg	Wide	94 %	0.520	TE: Solderless Connector part nr. 2213382-2 + Z50 Optic Clip part nr. 2213194-1

D

C

B

A

4

4

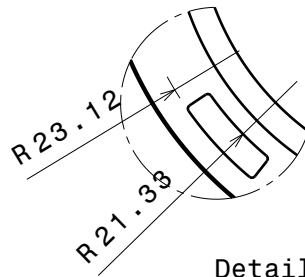
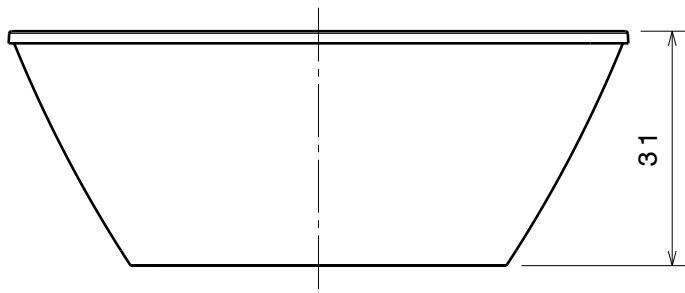

Detail B
Scale: 2:1

3

3

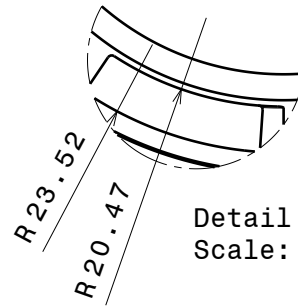
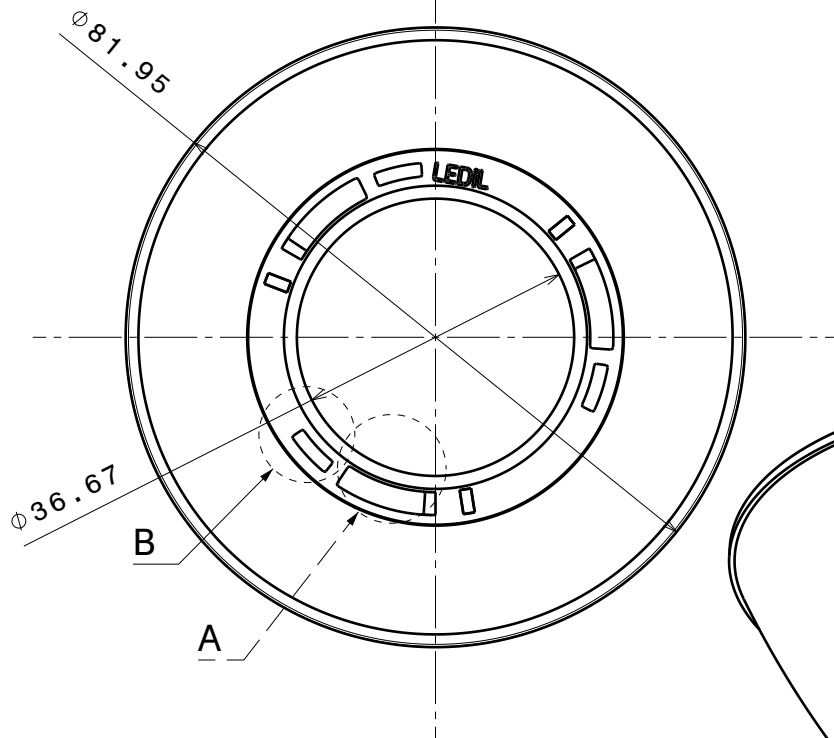

Detail A
Scale: 2:1

2

2

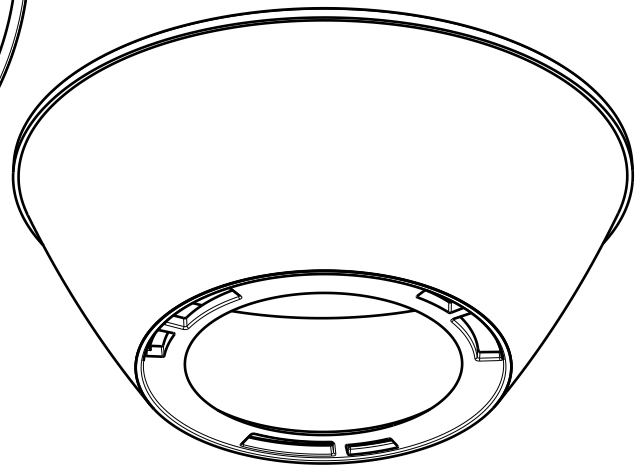

1

1

INDEX	PART NO	DESCRIPTION	MATERIAL	COLOR
1		ANGELINA	Reflective PC	White

Tolerances if not otherwise shown
According to DIN ISO 2768-1
Linear measures:
Up to 30mm class M, otherwise class C.
According to DIN ISO 2768-2
Form and position: class L



Ledil Oy
Salorankatu 10
FIN 24240 SALO
Finland

THIRD ANGLE PROJECTION:

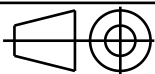

DRAWING TITLE

ANGELINA series Reflector

This drawing is the property of LEDiL Oy. It may not be reproduced, copied or communicated without a written agreement with LEDiL Oy."

SIZE PART NUMBER

A4

-

SCALE 1:1 WEIGHT - SHEET 1/1

D

A

Luminaire: LEDil Oy F13838_ANGELINA-XW_(NFDxJ130B)
Lamps: 1 x Nichia NFDxJ130B (SM403G6450R8000) 1410.46lm @ 250mA P=8.9W I=250mA

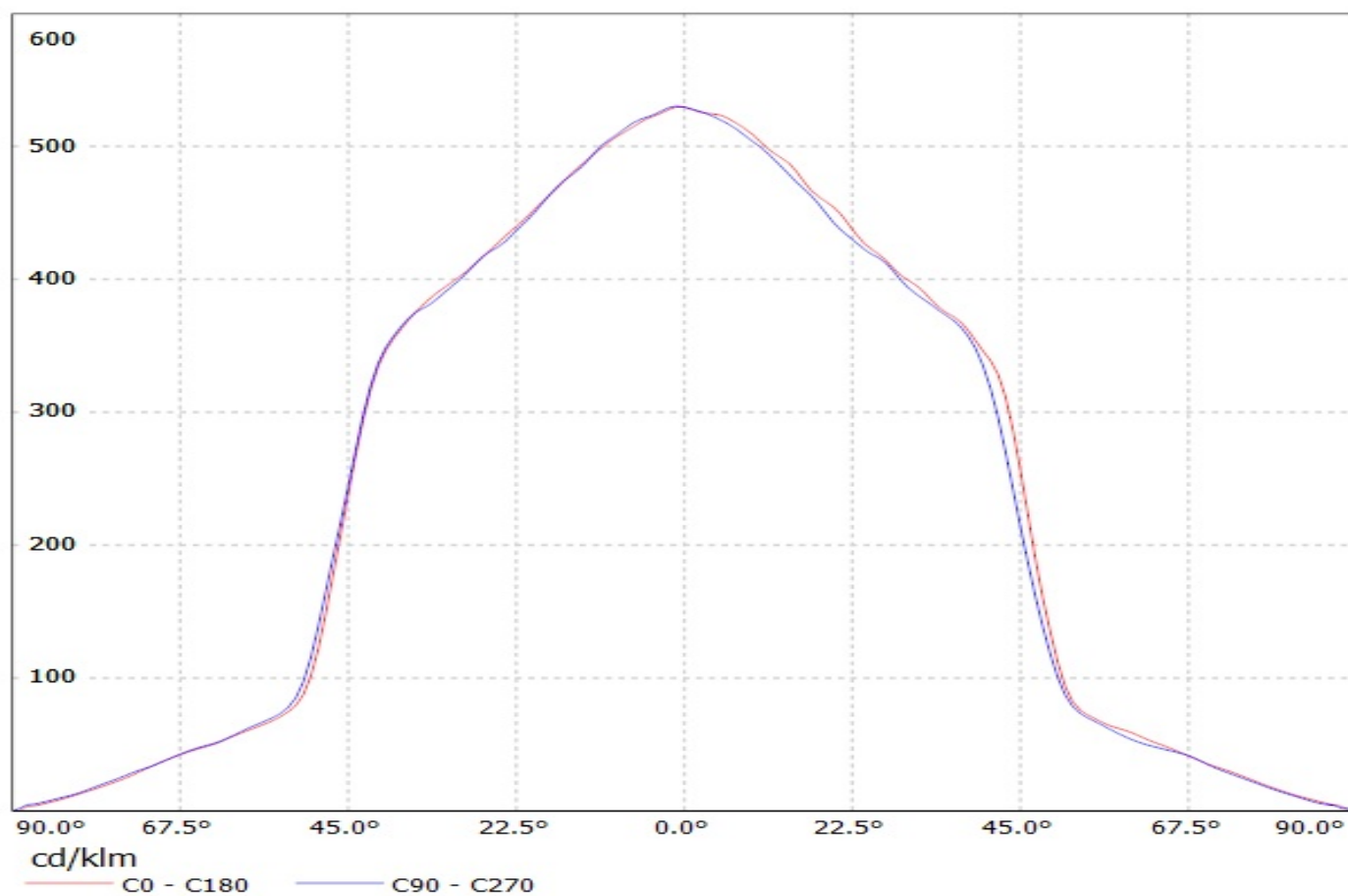

Luminaire: LEDiL Oy F13838_ANGELINA-XW_(LEP-2000-827-C-AC)
Lamps: 1 x OSRAM PrevaLED Core AC (LEP-2000-827-C-AC)

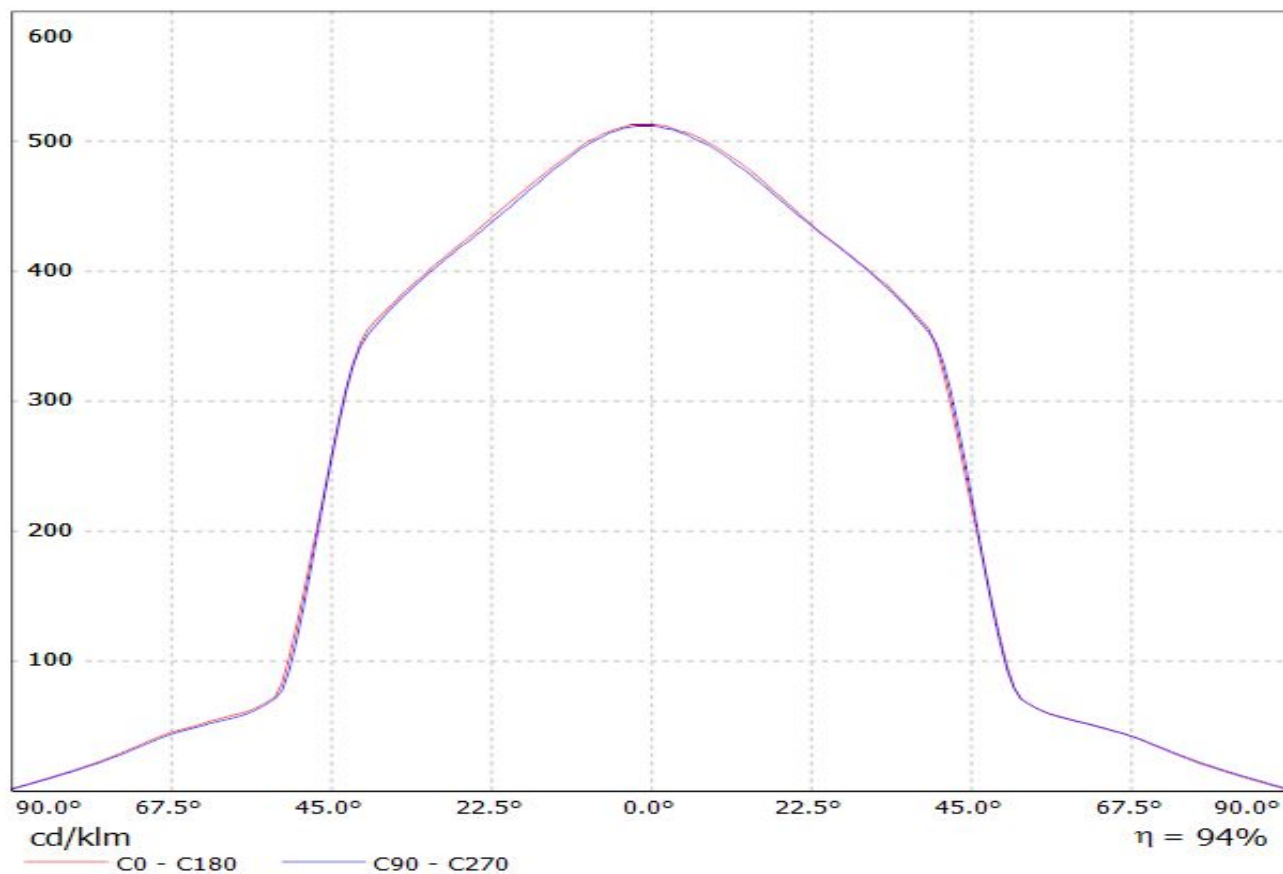

Luminaire: LEDiL Oy F13838_ANGELINA-XW_(CLL030)

Lamps: 1 x Citizen_CLL030_(CLL030-1206A1-303M1A2)_971.531lm@250mA_P=8.42026W_I=249.8mA

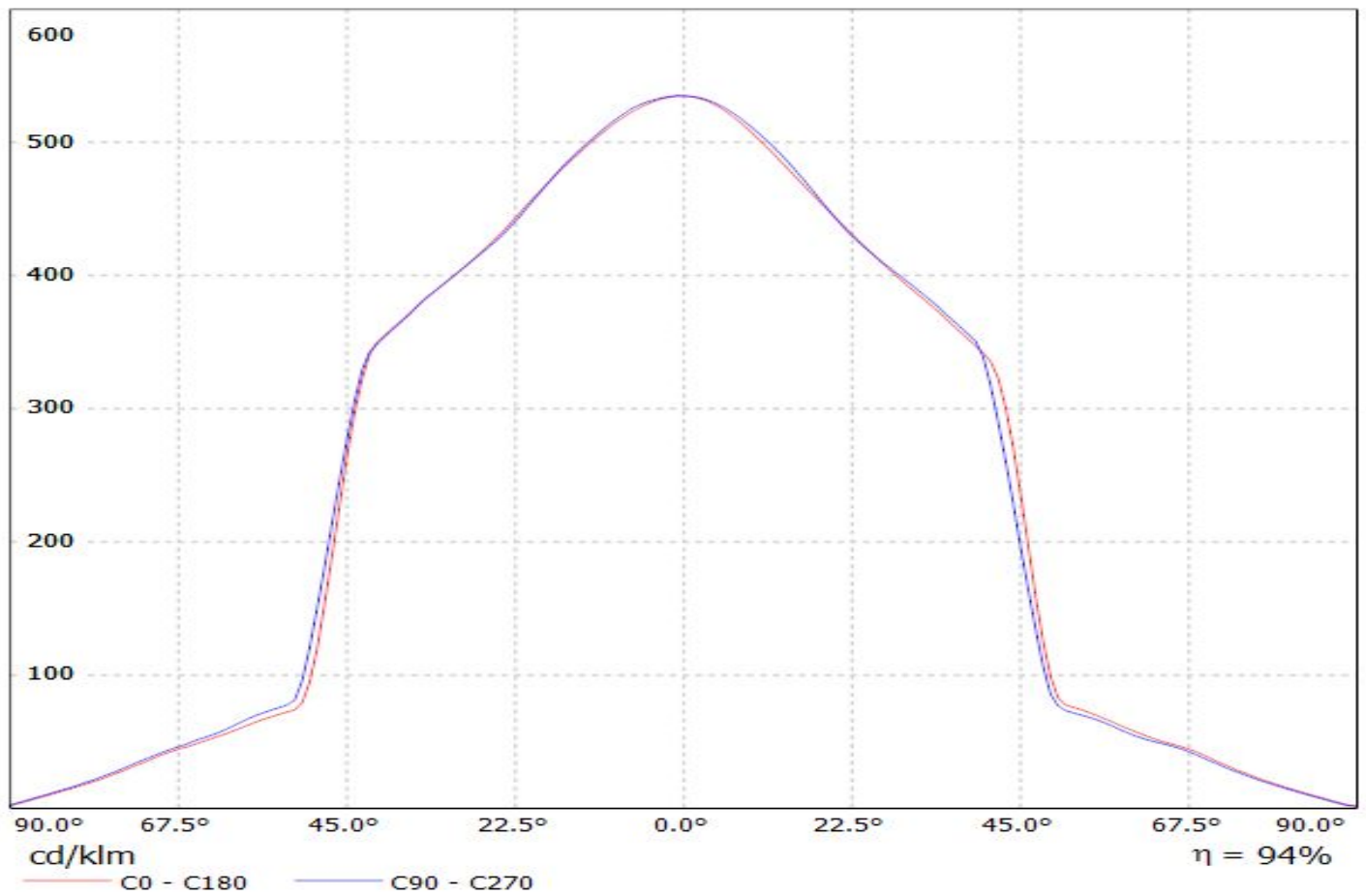

Luminaire: Ledil F13838_ANGELINA-XW_(CLU720)
Lamps: 1 x CITIZEN_CLU720_(CLU720-1206B8-273M2)
_1337.27lm@250mA_CCT=2700K_P=8.35W_I=0.25A

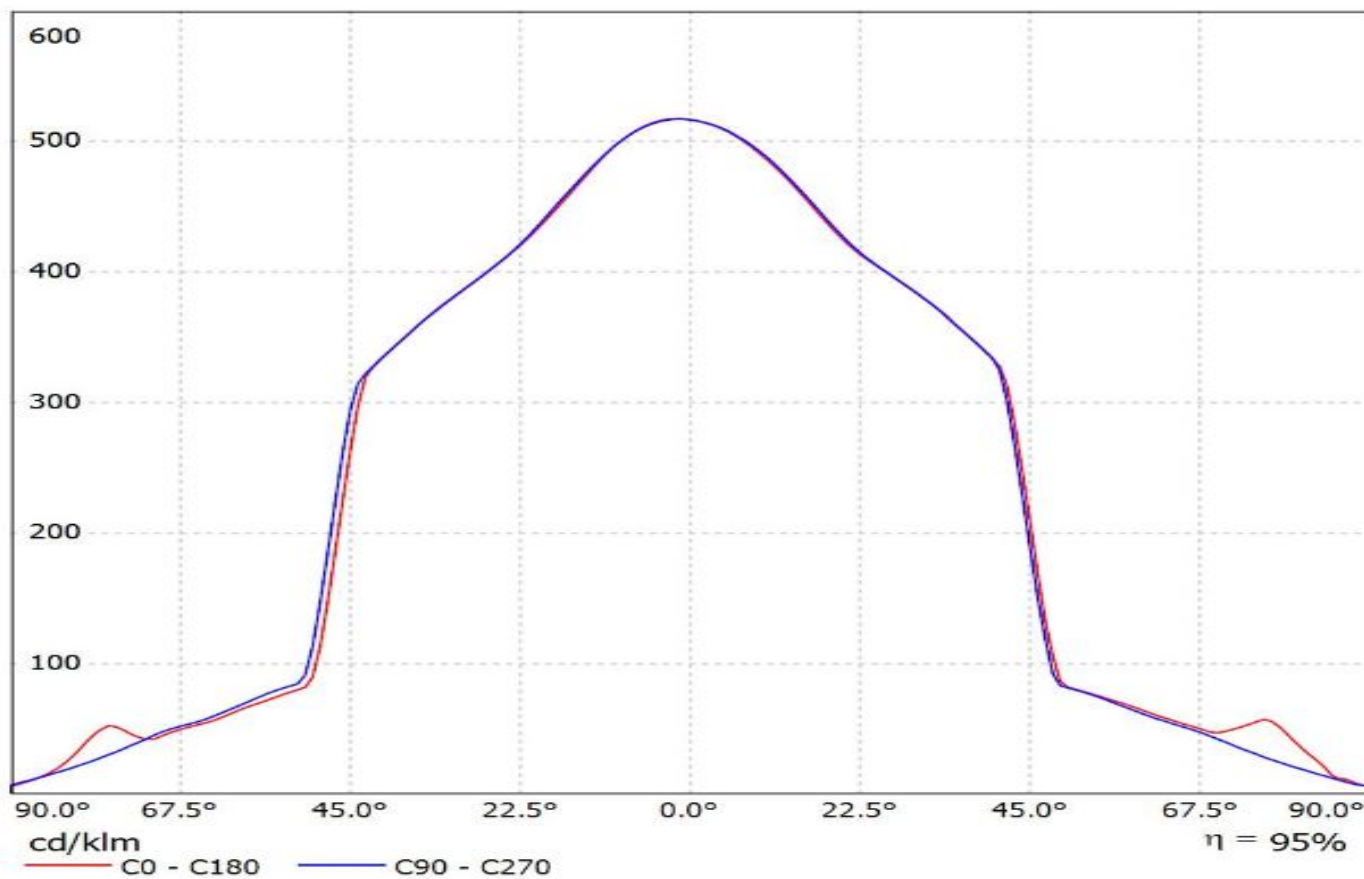

Luminaire: LEDiL Oy F13838_ANGELINA-XW_(SLM_4500) Eff.94.3%
Lamps: 1 x Philips_FORTIMO_SLM_4500_1139.88lm@250mA_P=10.7416W_I=249.8mA

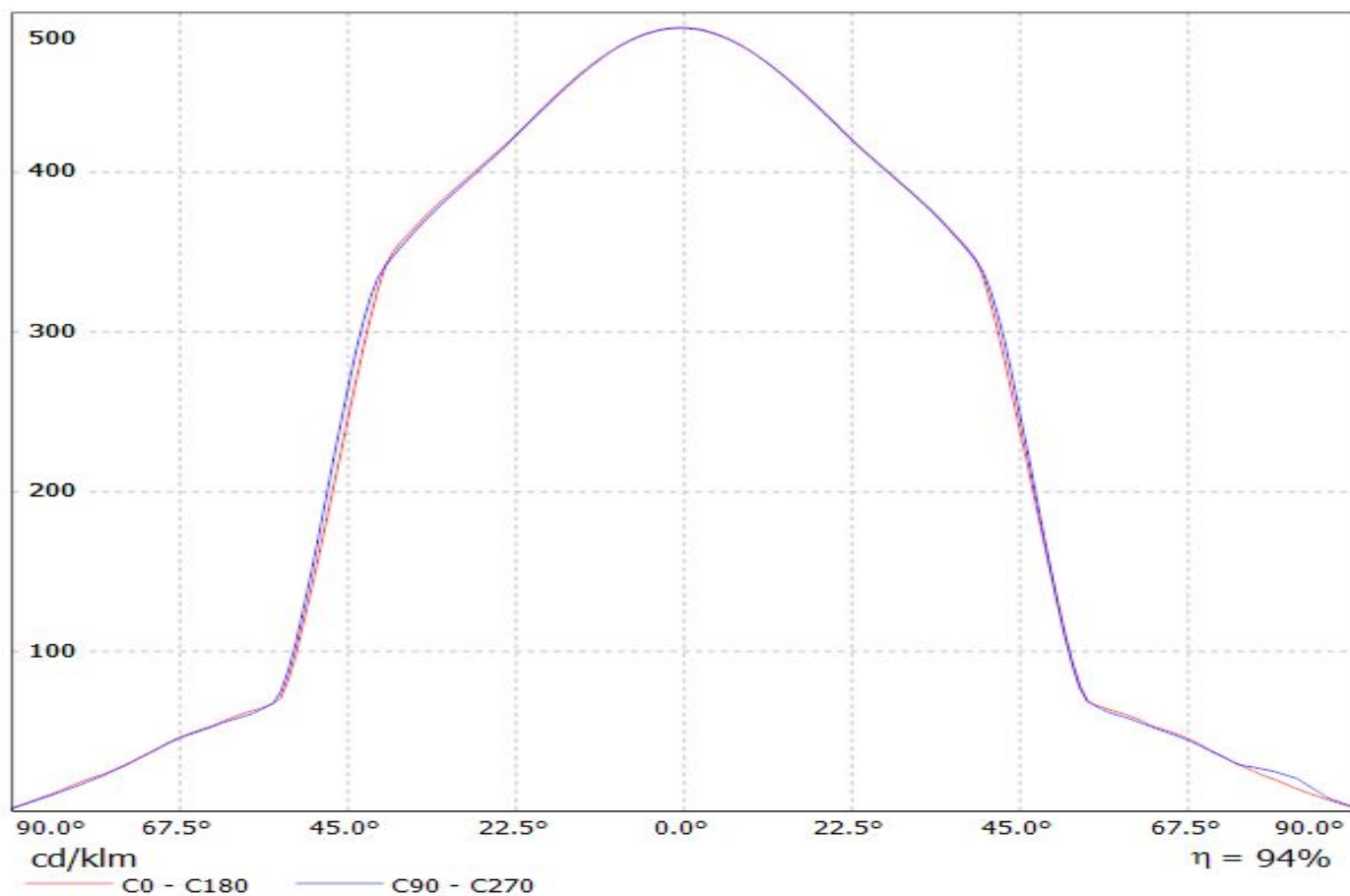

Luminaire: LEDiL Oy F13838_ANGELINA-XW_(LES26) Eff.94.4%

Lamps: 1 x Tridonic_STARK_SLE_G2_LES26_1048.24lm@250mA_P=8.04403W_I=249.9mA

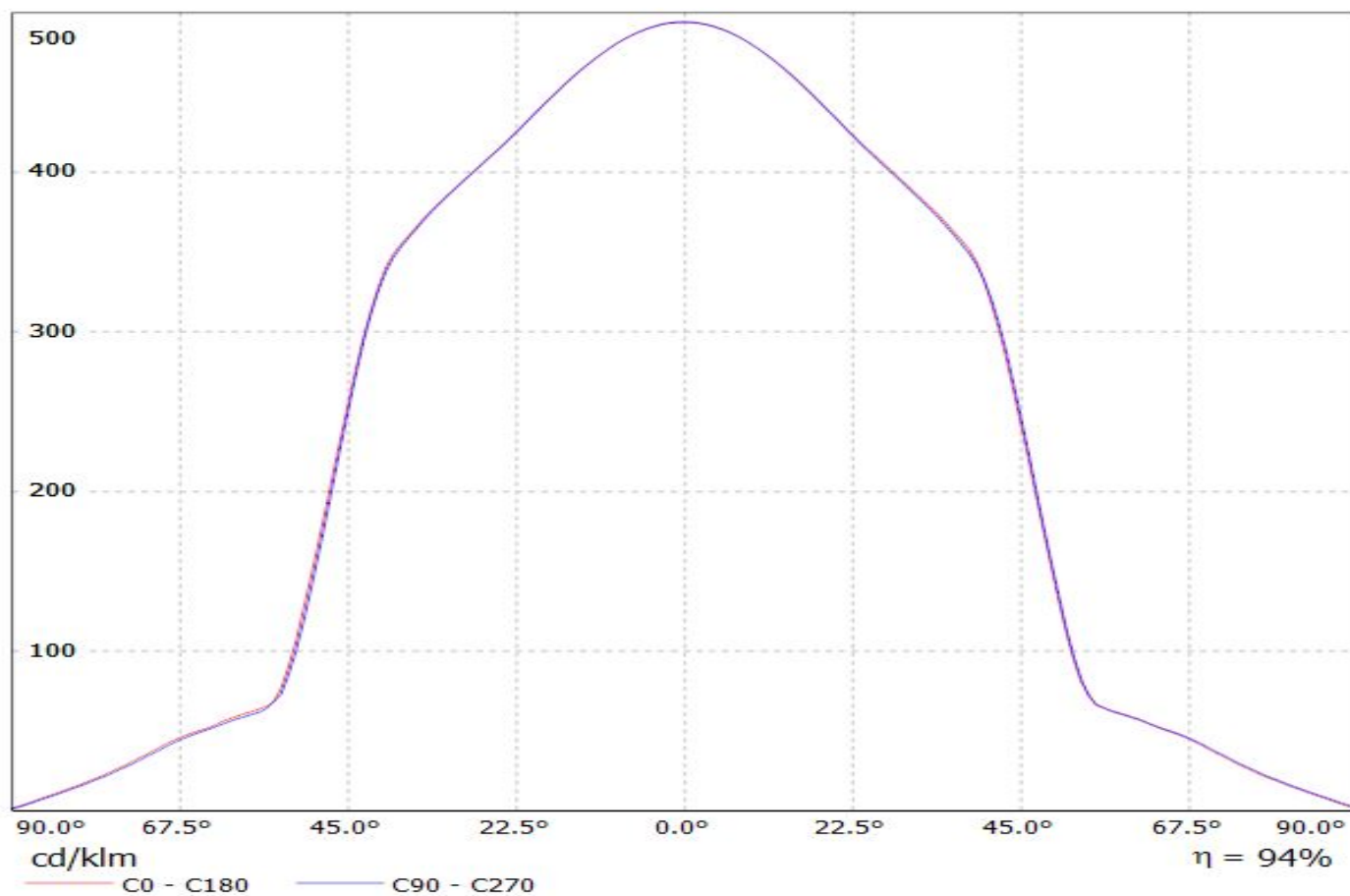

Luminaire: LEDiL Oy F13838_ANGELINA-XW_(LES23) Eff.94.1%
Lamps: 1 x Tridonic_STARK_SLE_G2_LES23_955.501lm@250mA_P=8.34207W_I=249.8mA

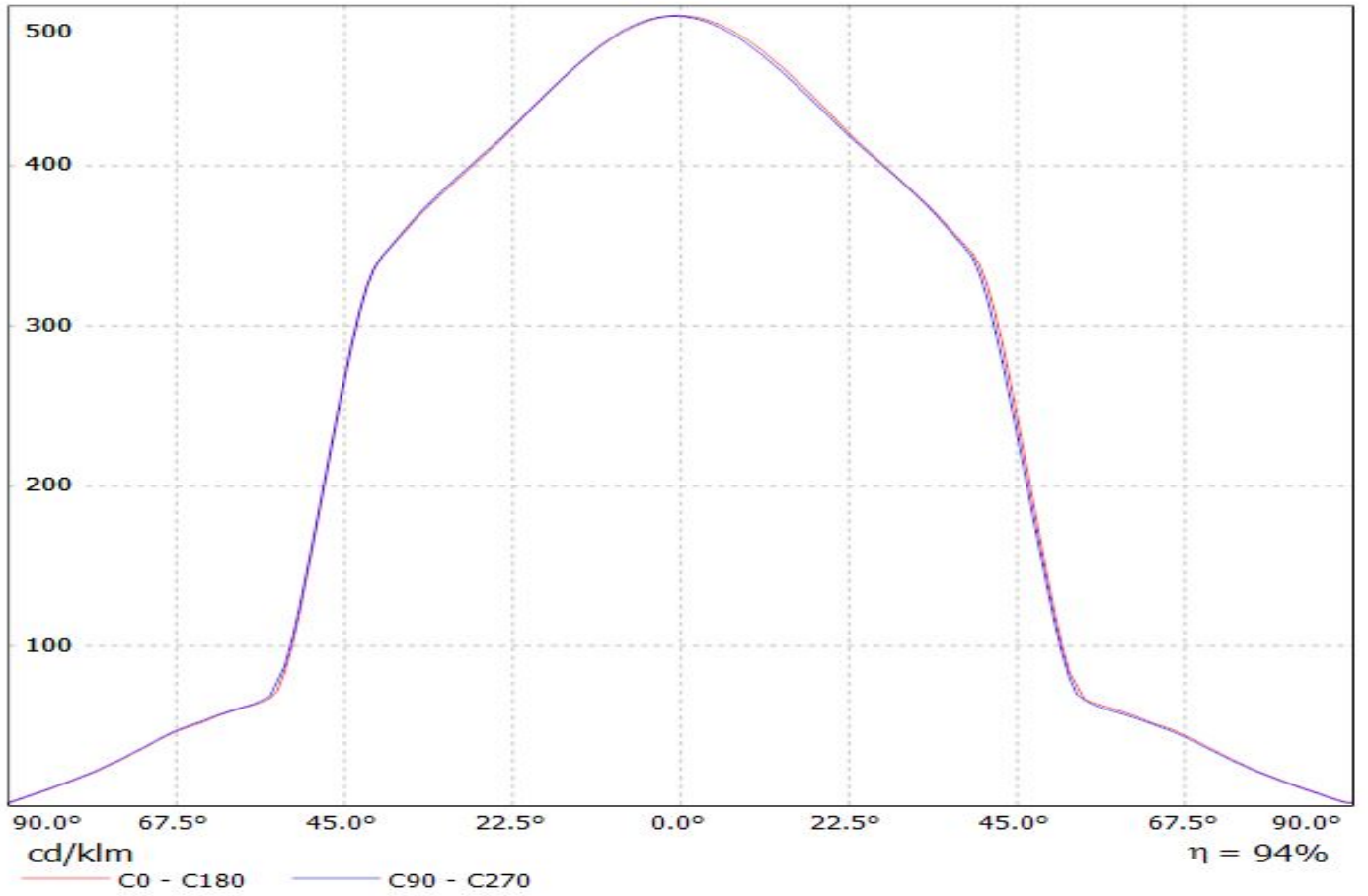

Luminaire: LEDiL Oy F13838_ANGELINA-XW_(LEP-800-827-C-AC)

Lamps: 1 x OSRAM PrevaLED Core AC (LEP-800-827-C-AC) 910lm@60mA U:230V P:14W

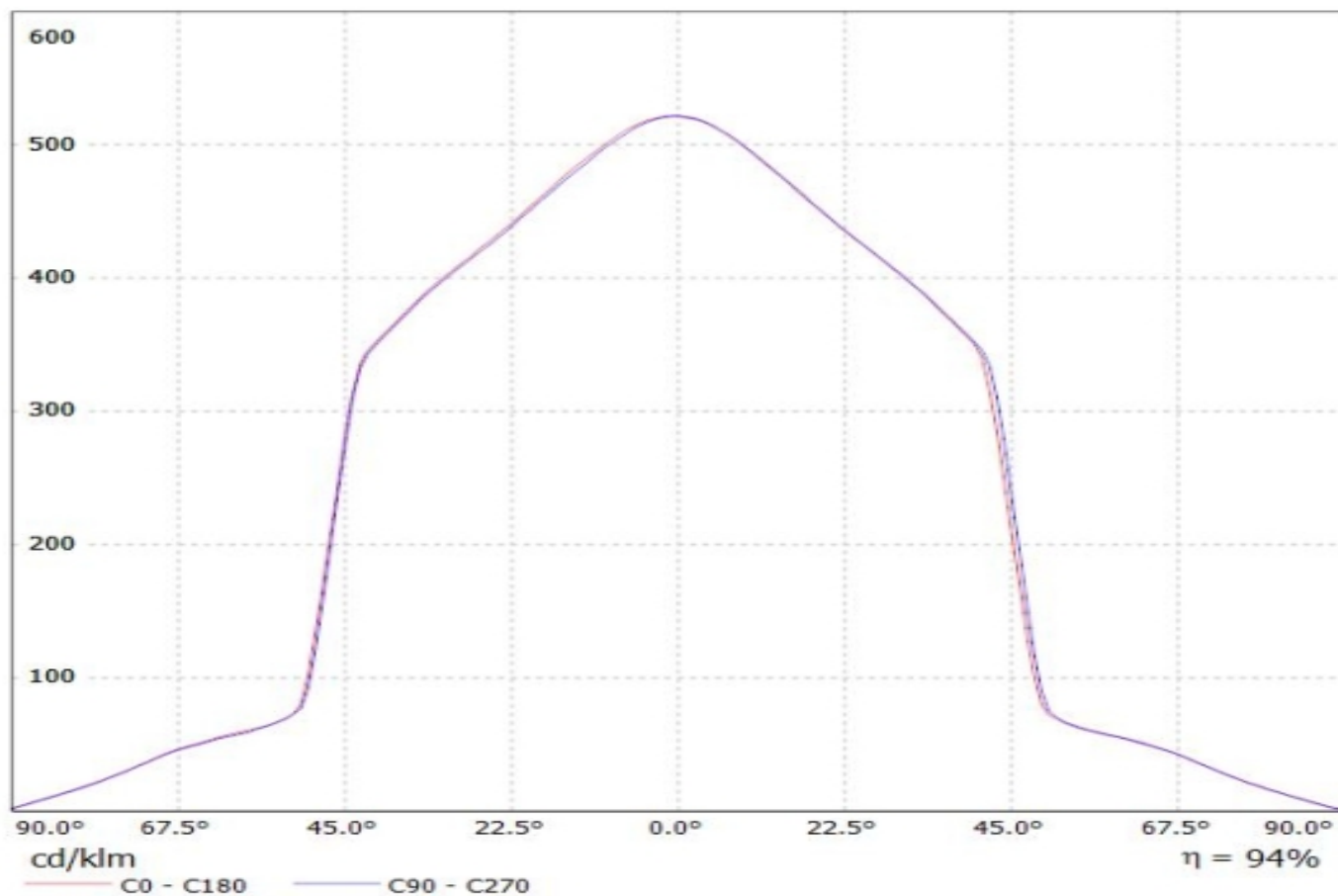

Luminaire: LEDiL Oy F13838_ANGELINA-XW_(PrevaLED_Z4) Eff: 94%
Lamps: 1 x Osram_PrevaLED_CORE_Z4_(PL-CORE-3000-830-Z4)_1433.3lm@250mA_P=10.7652W_I=249.9mA

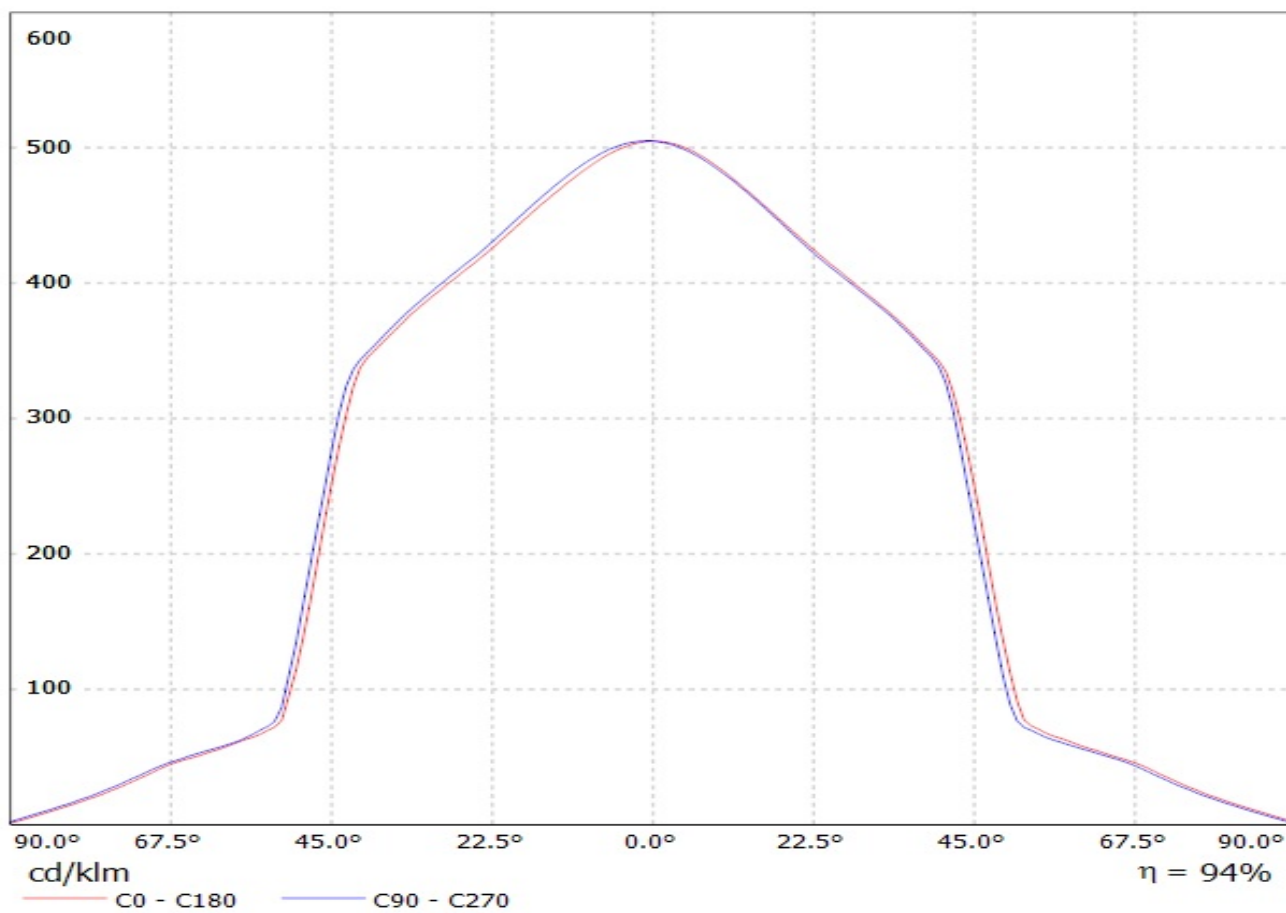

Luminaire: LEDiL Oy F13838_ANGELINA-XW_(Fortimo LED SLM L19 G4)
Lamps: 1 x Fortimo LED SLM L19 G4_1114.89lm@250mA_P=8.04906W_I=0.2498A

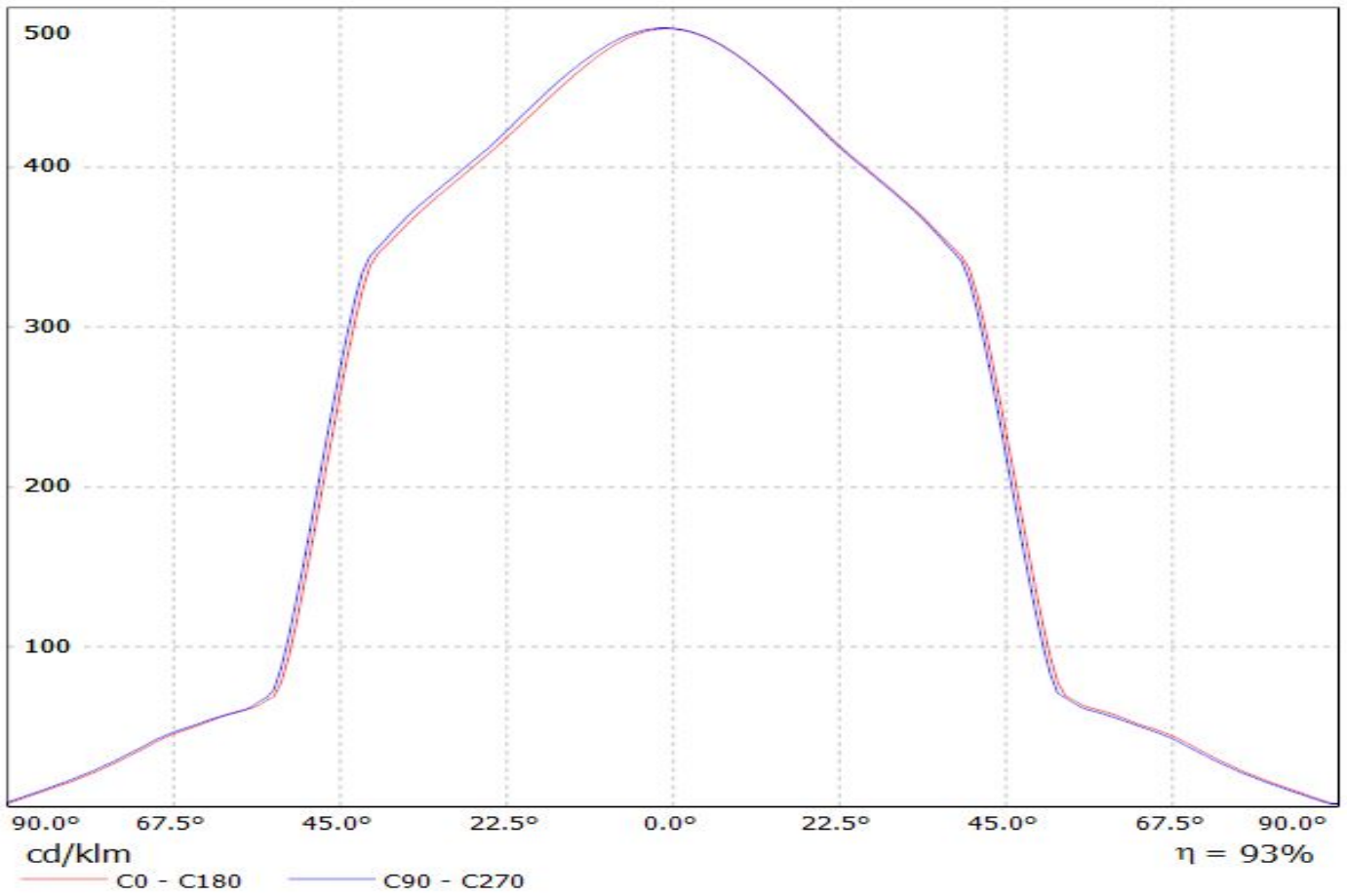

Luminaire: LEDiL Oy F13838_ANGELINA-XW_(SLE_G4_LES23)

Lamps: 1 x Tridonic_SLE_G4_LES23_1354.57lm@250mA_P=8.18744W_I=0.2498A

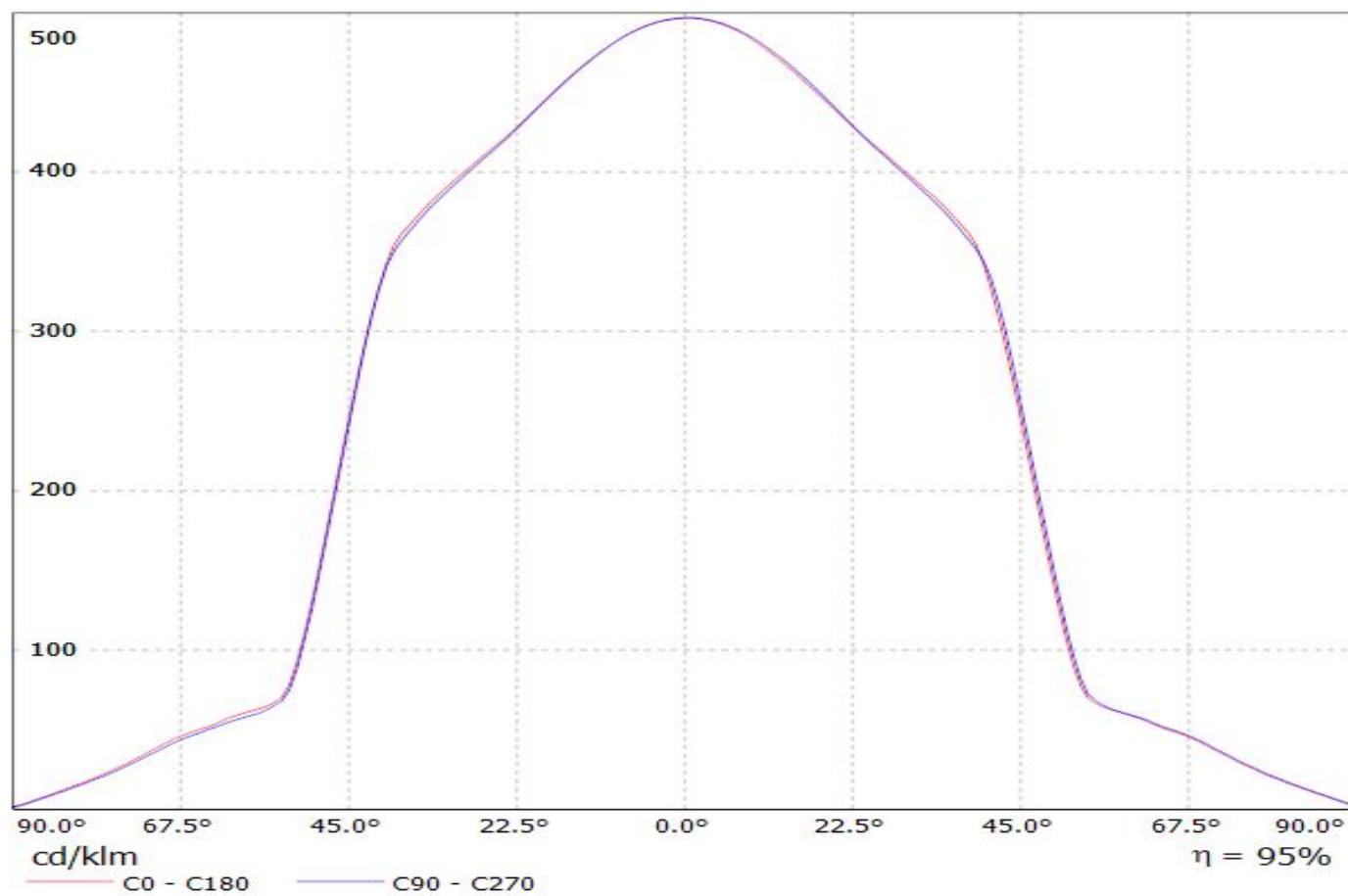

Luminaire: LEDiL Oy F13838_ANGELINA-XW_(K16) Eff.94.0%
Lamps: 1 x Luxeon_K16_1246lm@250mA_P=10.8991W_U=249.9mA

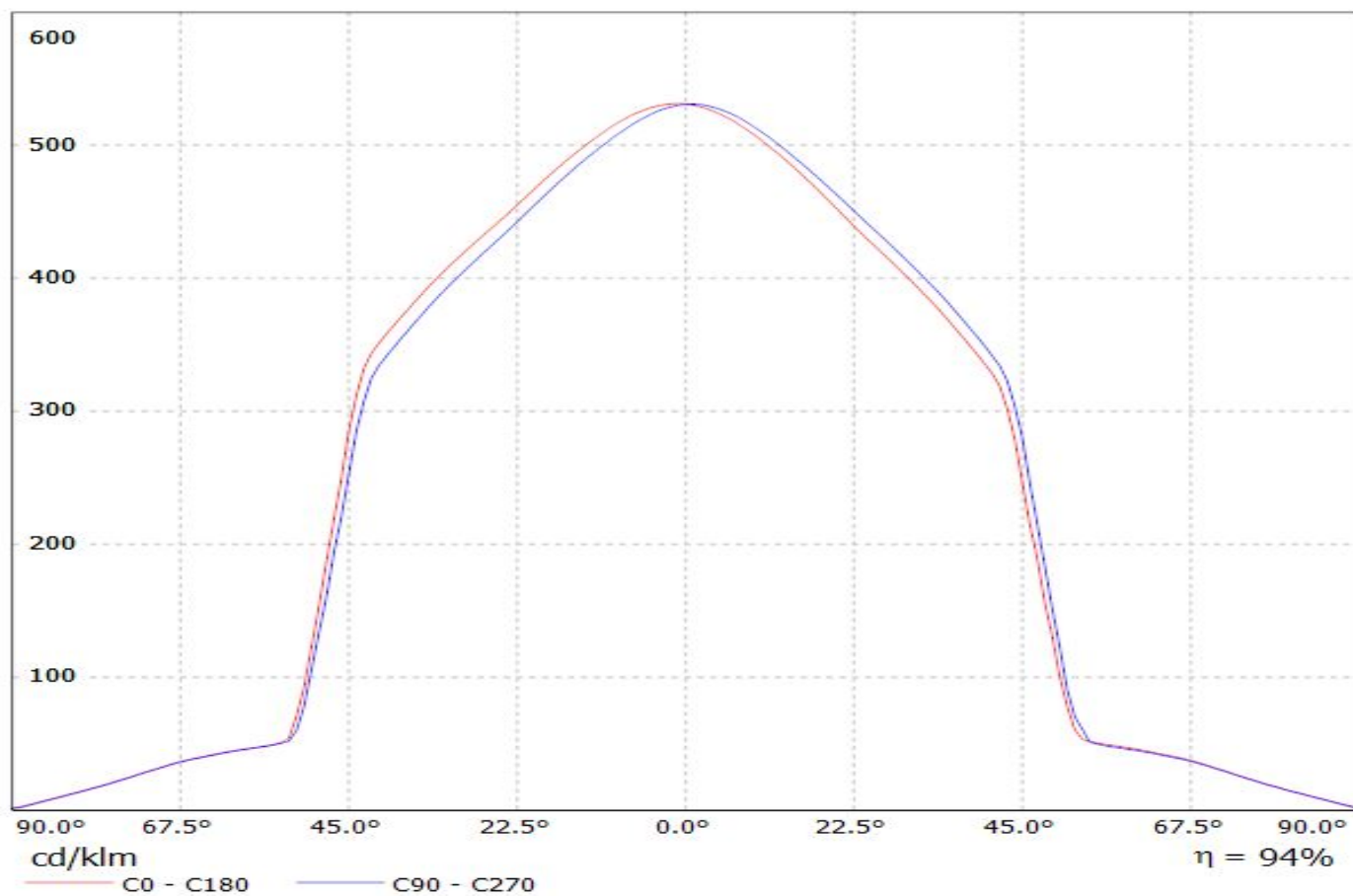

Luminaire: LEDiL Oy F13838_ANGELINA-XW_(CXA3590)

Lamps: 1 x CREE_CXA3590_(CXA3590-30F-BD-R0H-0002)_2640.14lm@250mA_CCT=3000K_P=16.3941W_I=249.8mA

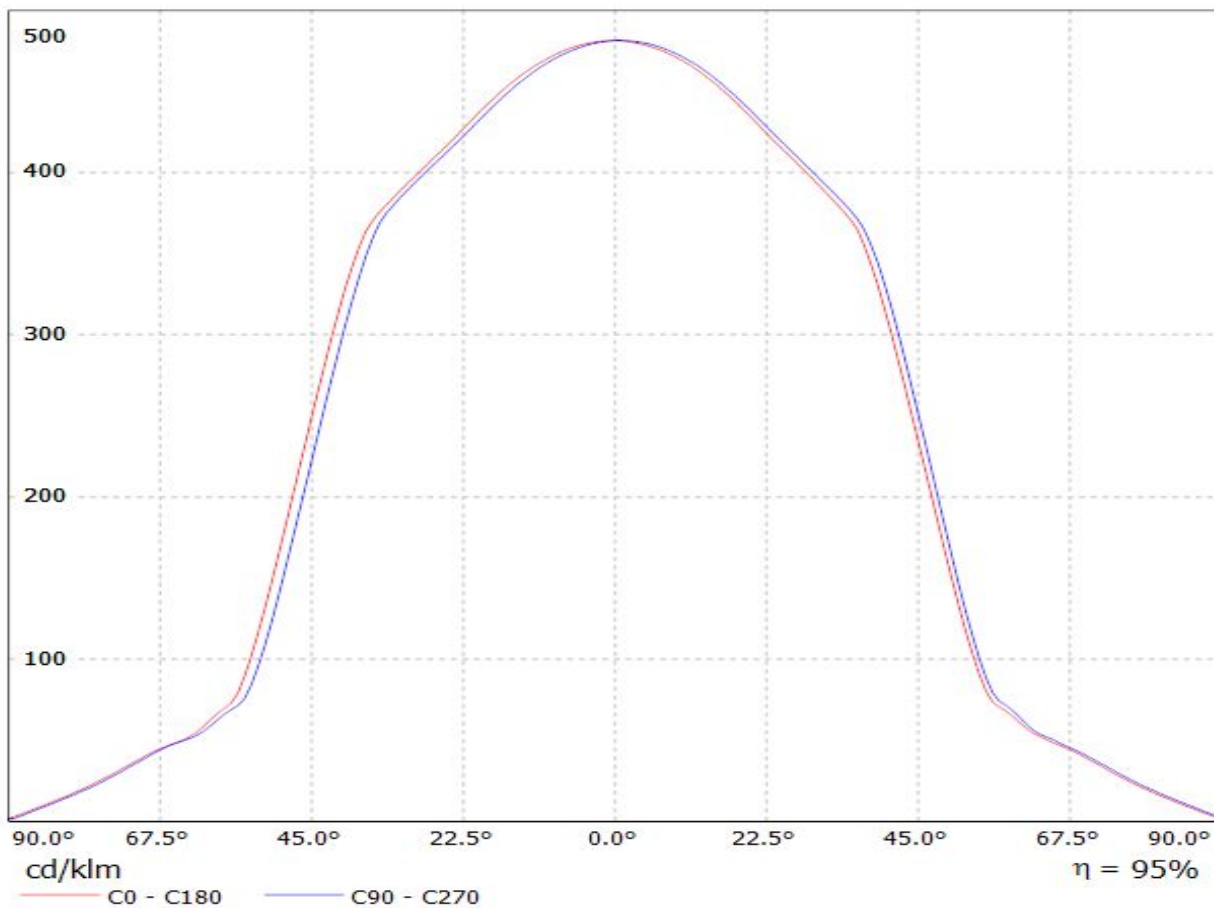

Luminaire: LEDiL Oy F13838_ANGELINA-XW_(SLM_2000) Eff.94.1%
Lamps: 1 x Philips_FORTIMO_SLM_2000_728.985lm@250mA_P=6.244W_I=249.9W

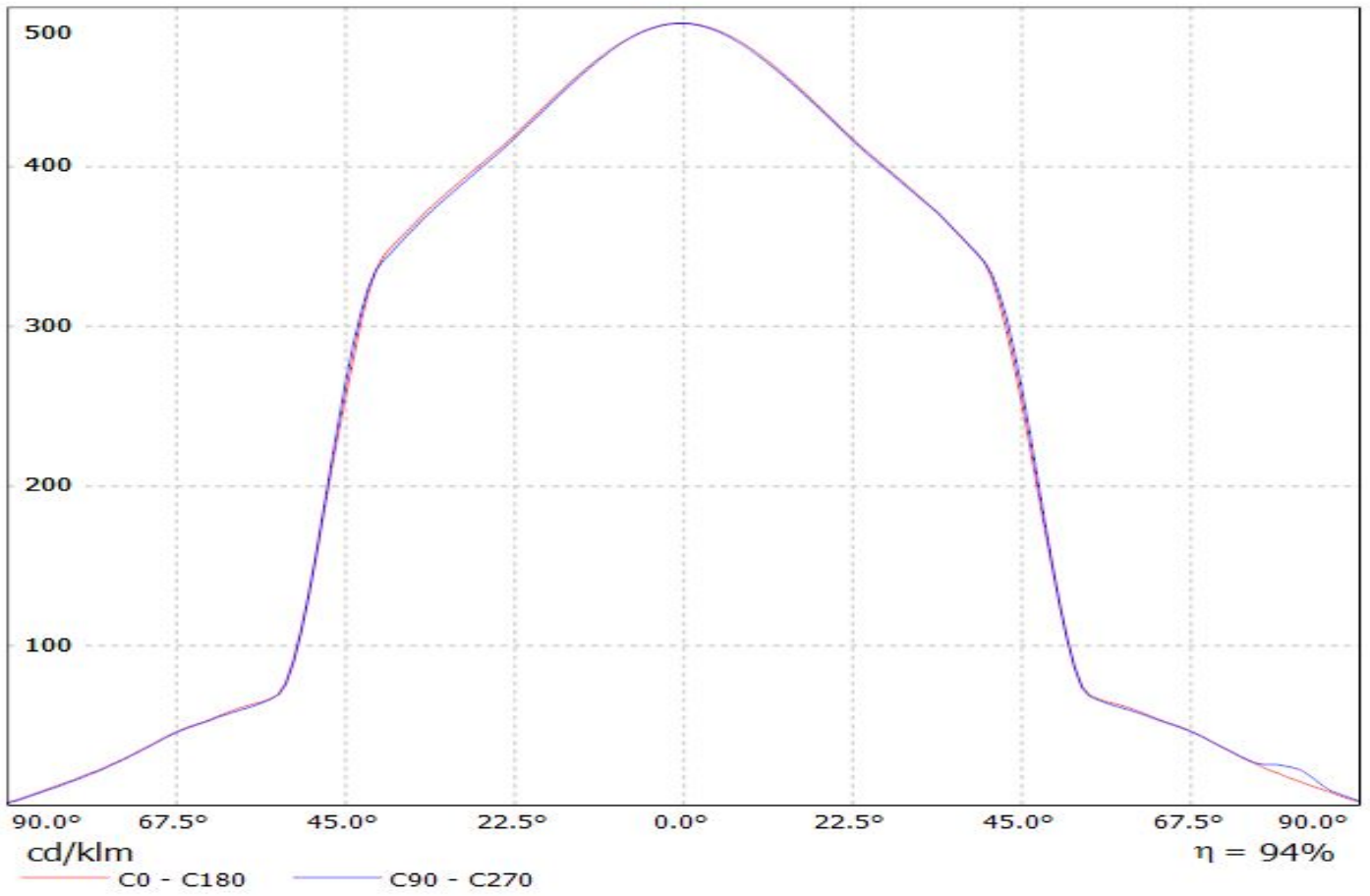

Luminaire: LEDiL Oy F13838_ANGELINA-XW_(SLM_3000) Eff.94.2%
Lamps: 1 x Philips_FORTIMO_SLM_3000_1066.81lm@250mA_P=8.8817W_I=249.9mA

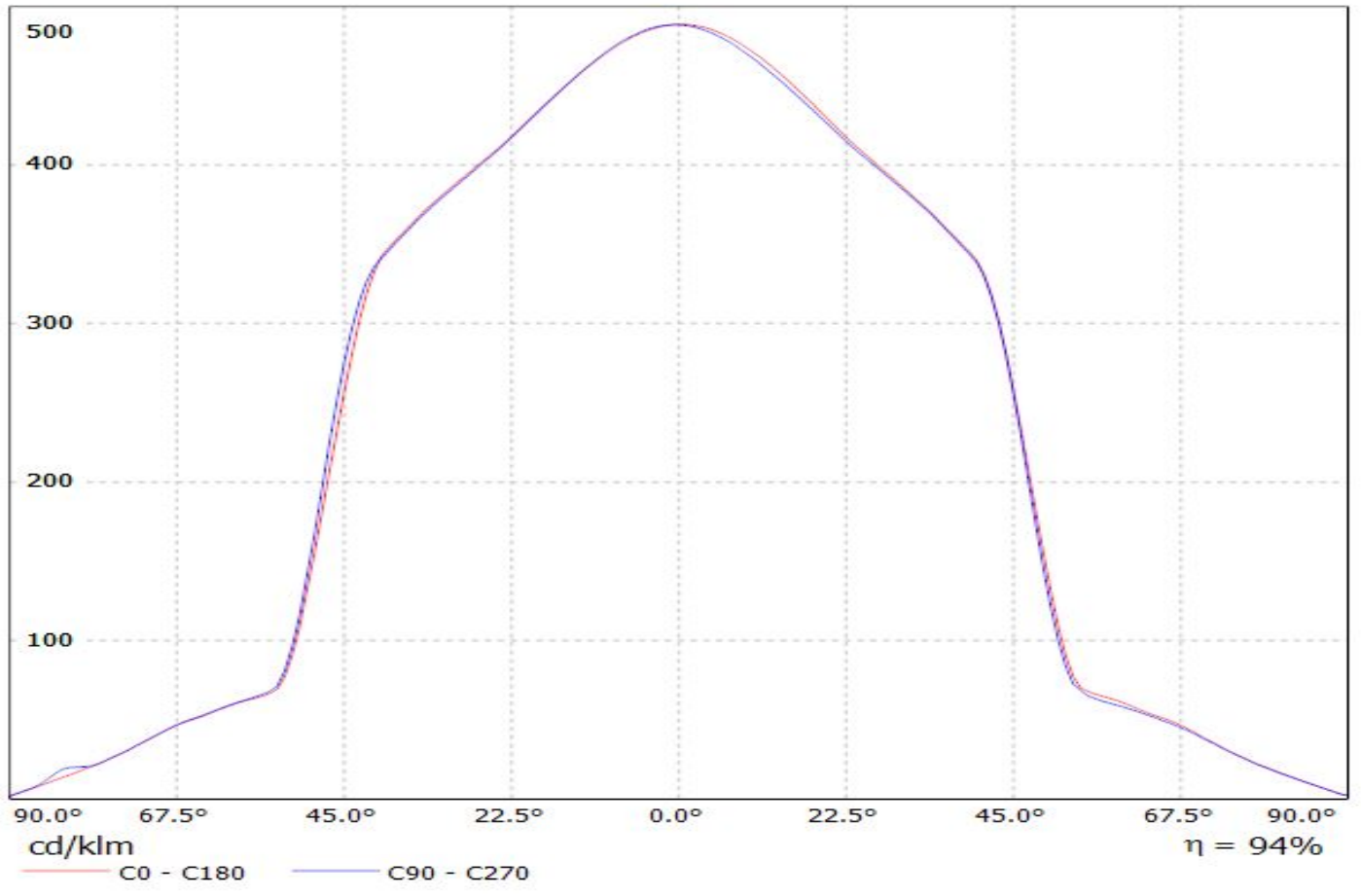

Luminaire: LEDiL Oy F13838_ANGELINA-XW_(LES19) Eff.94.4%
Lamps: 1 x Tridonic_STARK_SLE_G2_LES19_946.117lm@250mA_P=8.43263W_I=249.9mA

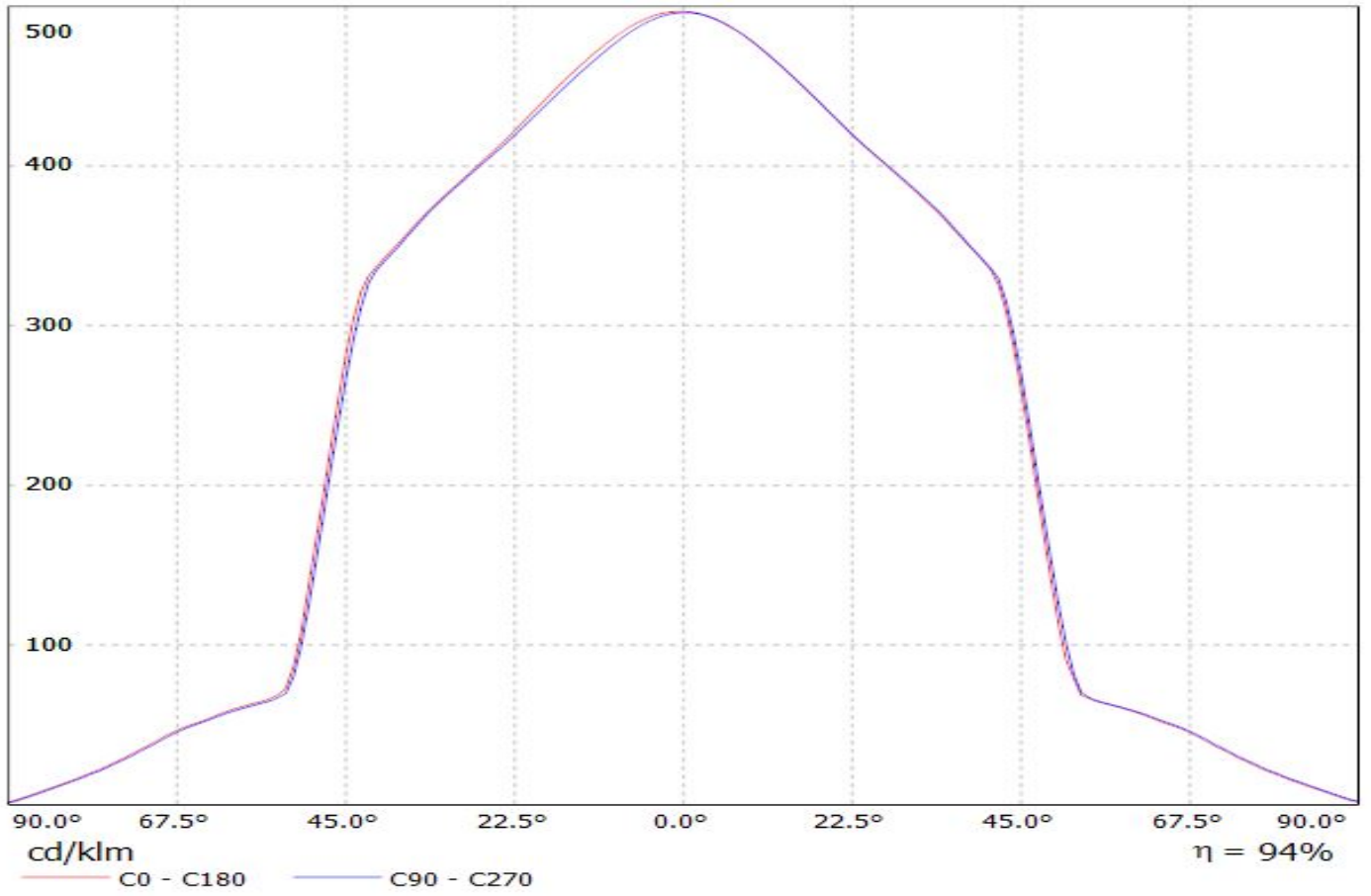

Luminaire: LEDiL Oy F13402_ANGELINA-W_(SOLERIQ_S19_&_TE_2213407-2)
Lamps: 1 x OSRAM_SOLERIQ_S19_(GW_KAHJB1.EM)_1393.62lm@250mA_CCT=3000K_P=10.5683W_I=249.8mA

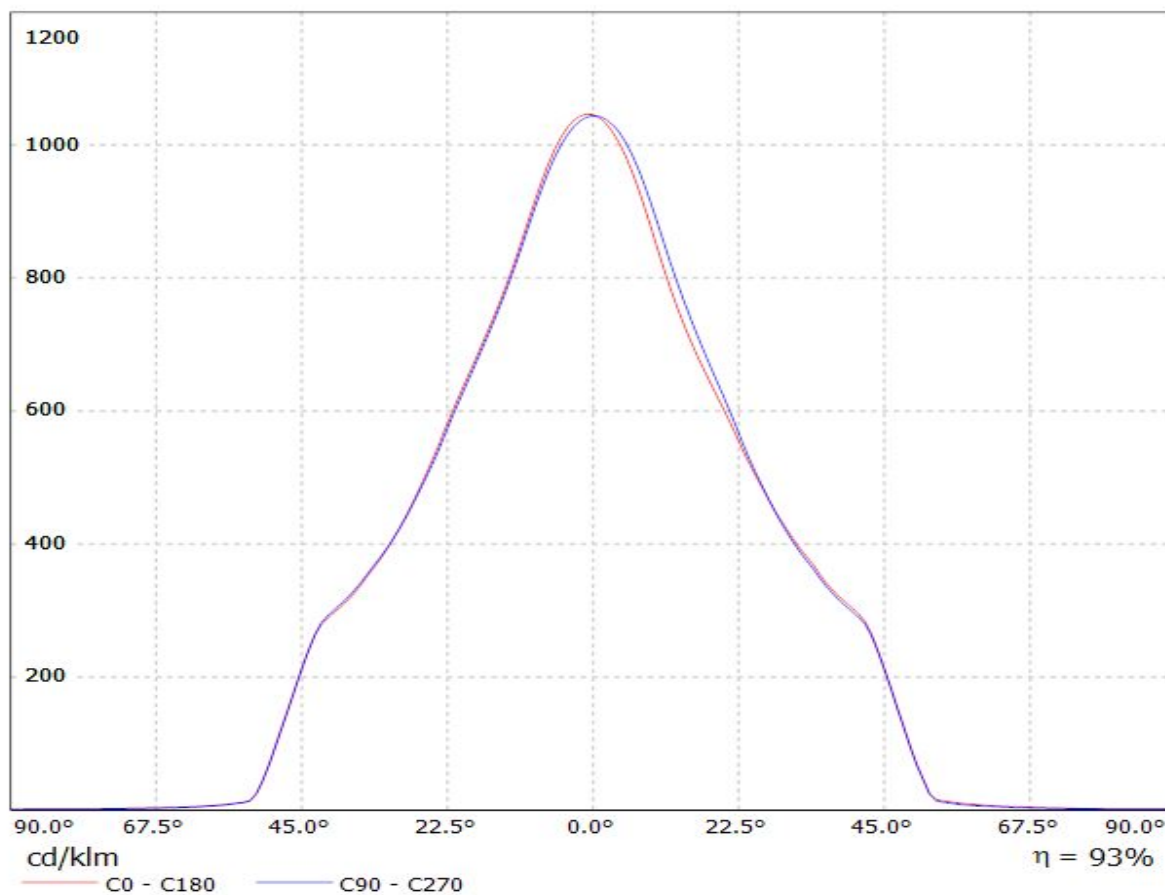

Luminaire: LEDiL Oy F13838_ANGELINA-XW_(Fortimo LED SLM L15 G4)
Lamps: 1 x Fortimo LED SLM L15 G4_1116.47lm@250mA_P=8.21168W_I=0.2498A

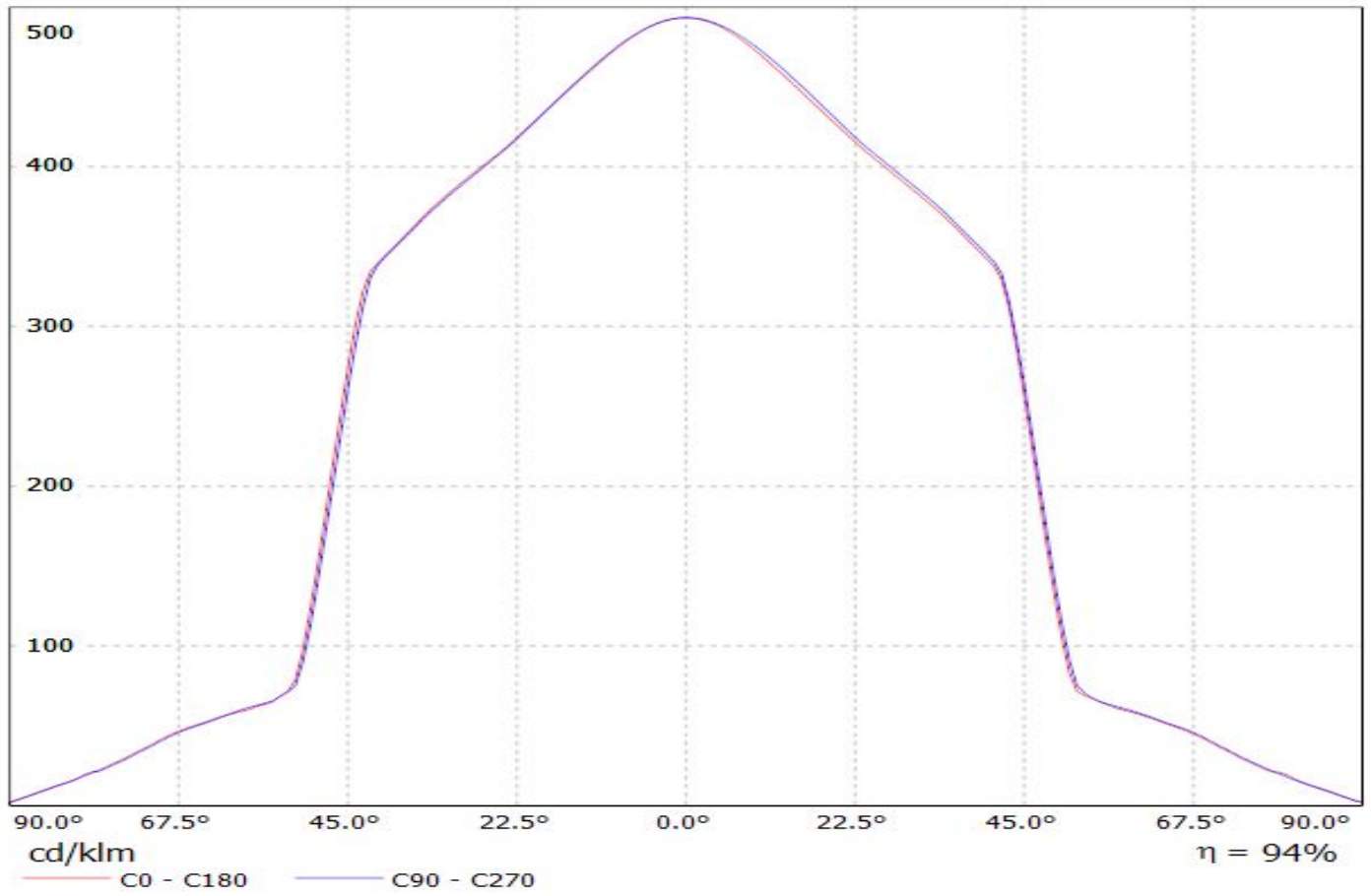

Luminaire: LEDiL Oy F13838_ANGELINA-XW_(SLE GEN4 LES19)
Lamps: 1 x SLE GEN4 LES19_1226.28lm@250mA_P=8.21367W_I=0.2498A

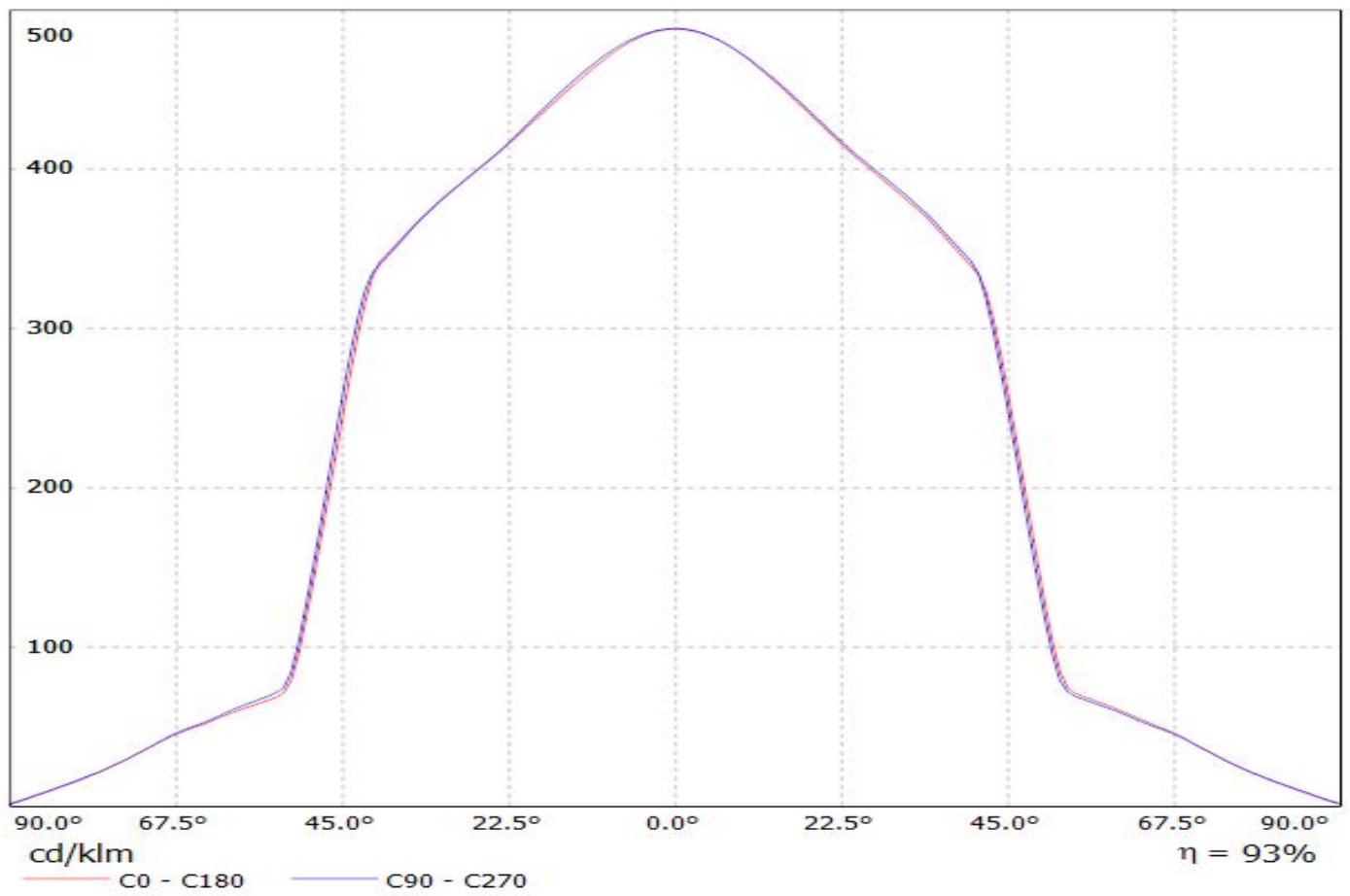

Luminaire: LEDiL Oy F13838_ANGELINA-XW_(K12) Eff.94.0%
Lamps: 1 x Luxeon_K12_937.4lm@250mA_CCT=4000K_P=8.19472_I=249.9mA

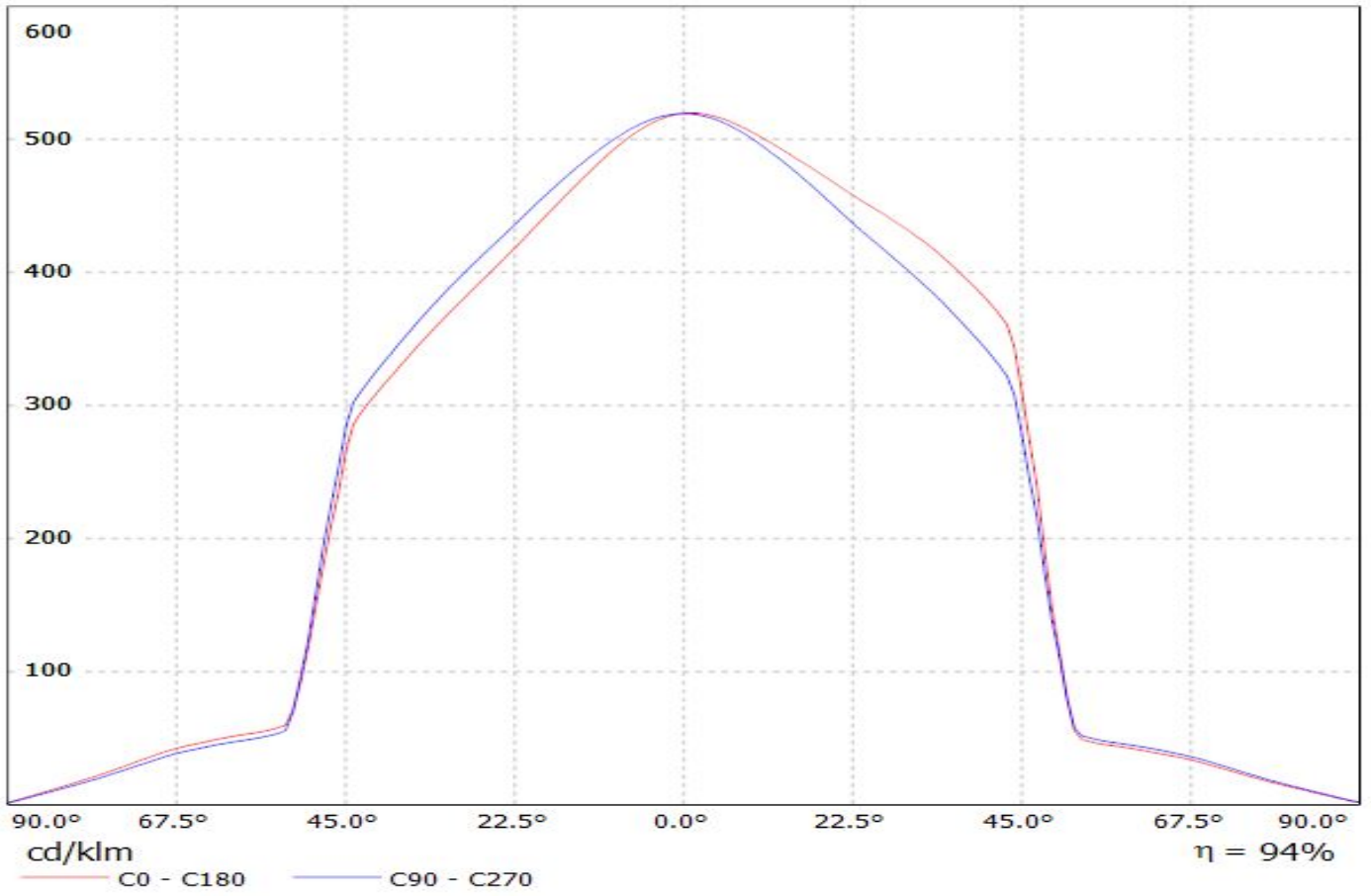

Luminaire: LEDiL Oy F13838_ANGELINA_XW_(MZ) Eff.94.0%
Lamps: 1 x Sharp_Mega_Zenigata_1226.07lm@250mA_P=11.1573W_I=249.8mA

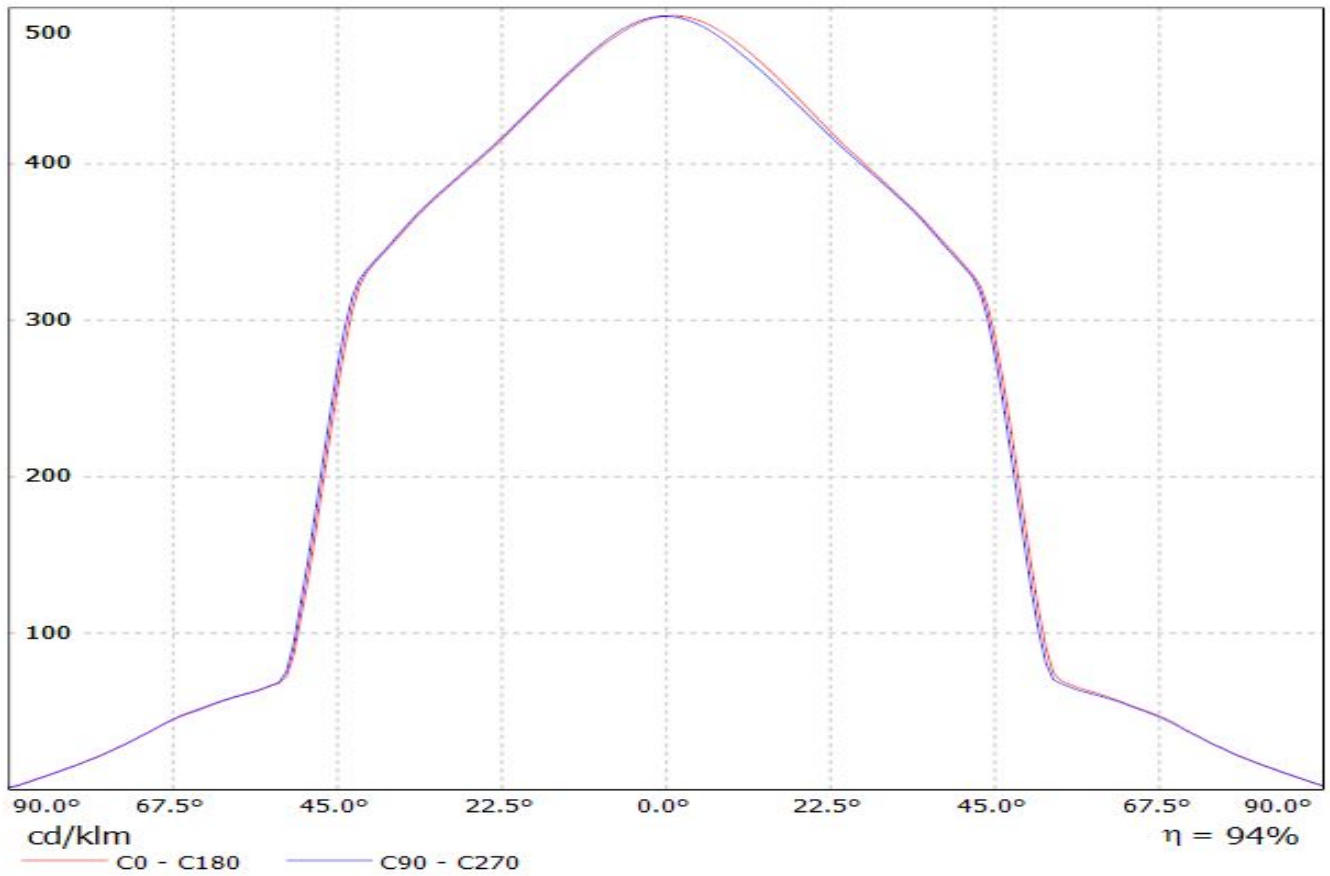

Luminaire: LEDiL Oy F13838_ANGELINA-XW_(WU-M-486) Eff.93.5%
Lamps: 1 x Vossloh_Schwabe-WU-M-486_(WU-M-486-830)
_1474.55lm@250mA_P=10.4456W_I=249.8mA

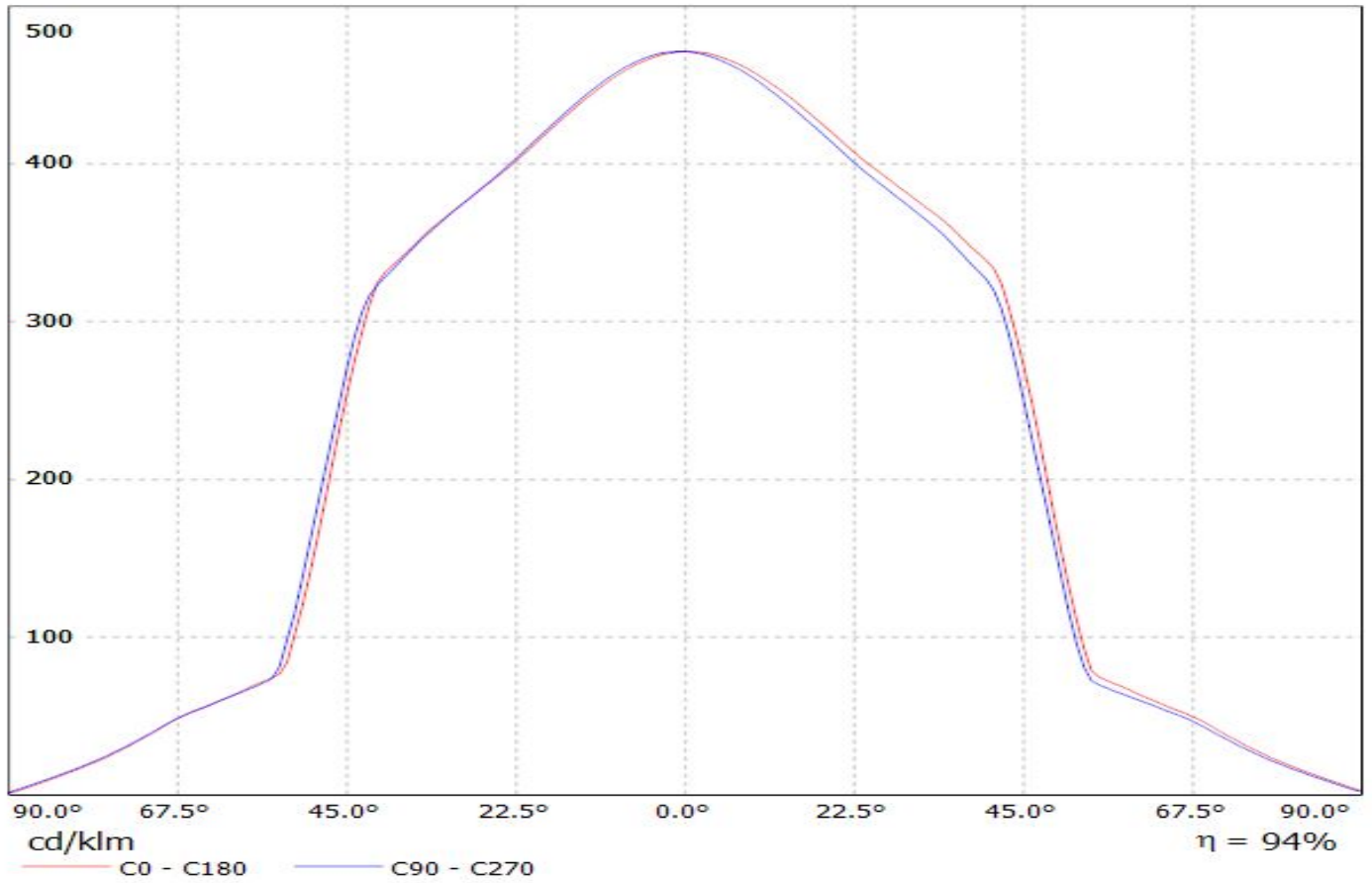

Luminaire: LEDiL Oy F13838_ANGELINA-XW_(SOLERIQ_P13)

Lamps: 1 x SOLERIQ_P13_(GW_MAGMB1.EM)_1038.25lm@250mA_CCT=3000K_P=8.77223W_I=249.8mA

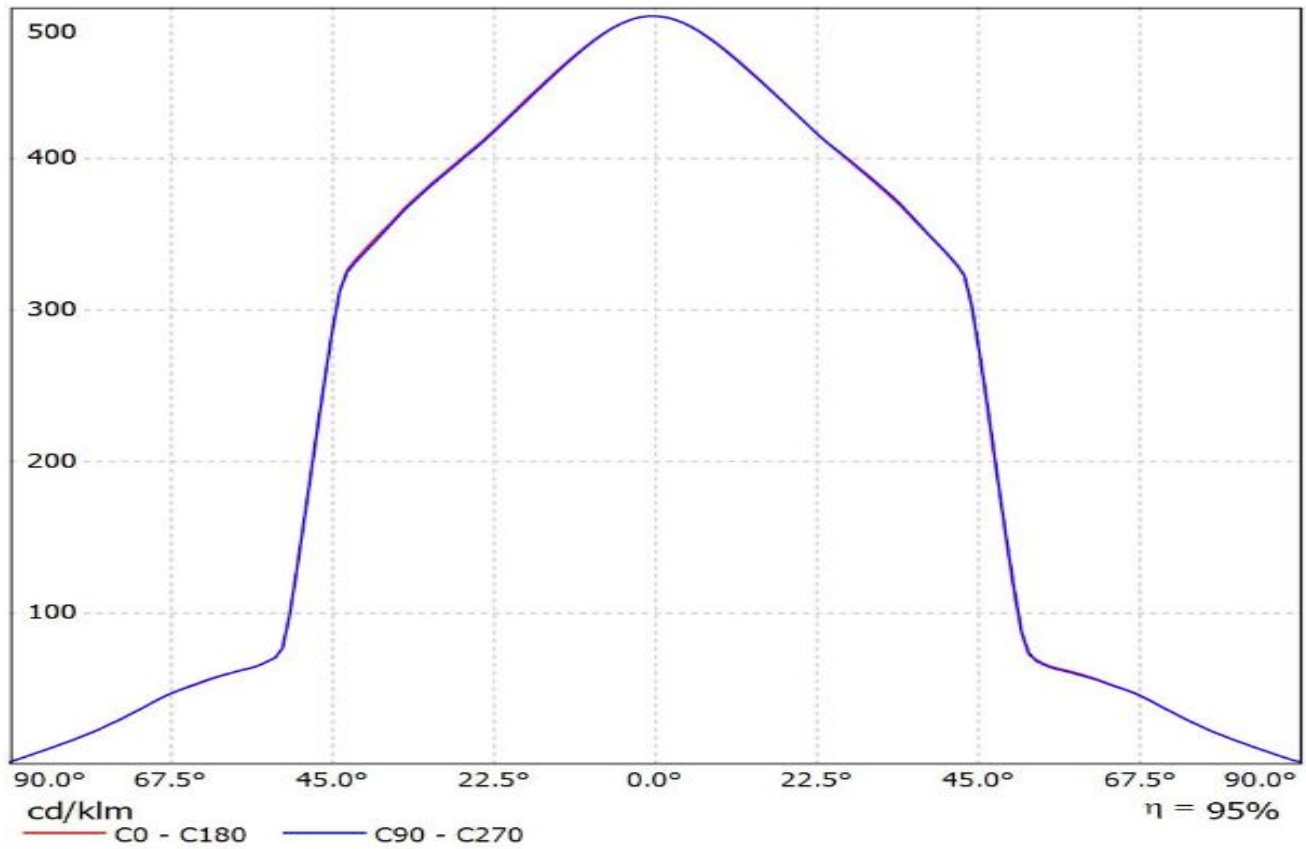

Luminaire: LEDil Oy F13838_ANGELINA-XW_(Soleriq_S13) Efficiency=94%
Lamps: 1 x Osram Soleriq S13 (GW KAGHB1.EM) 855lm @ 250mA CCT=3100K P=7.5W I=250mA

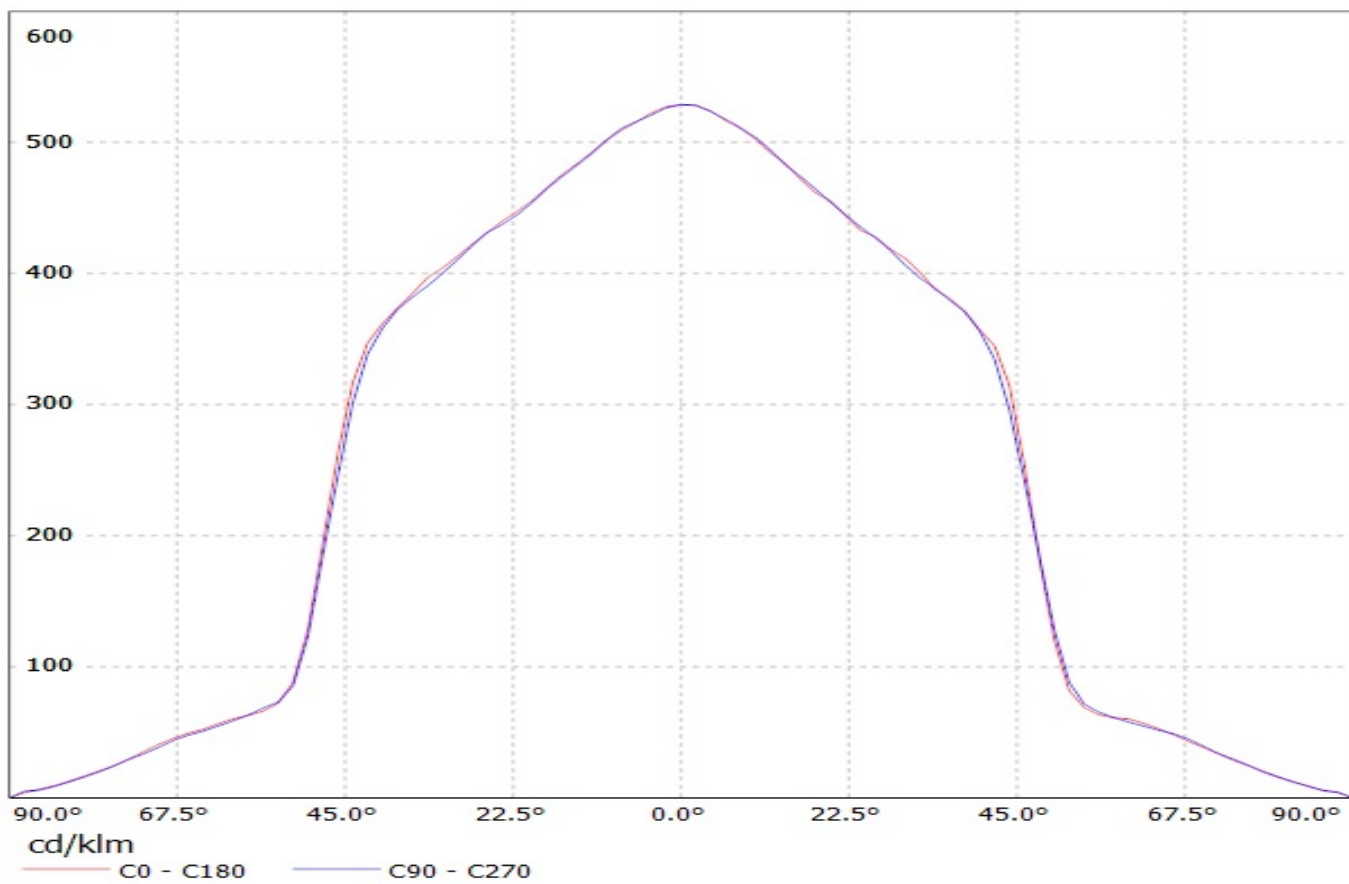

Luminaire: LEDil Oy F13838_ANGELINA-XW_(NFCxL060B)

Lamps: 1 x Nichia NFCxL060B (SM403G2450R8000) 1250.88lm @ 250mA P=8.4W I=250mA

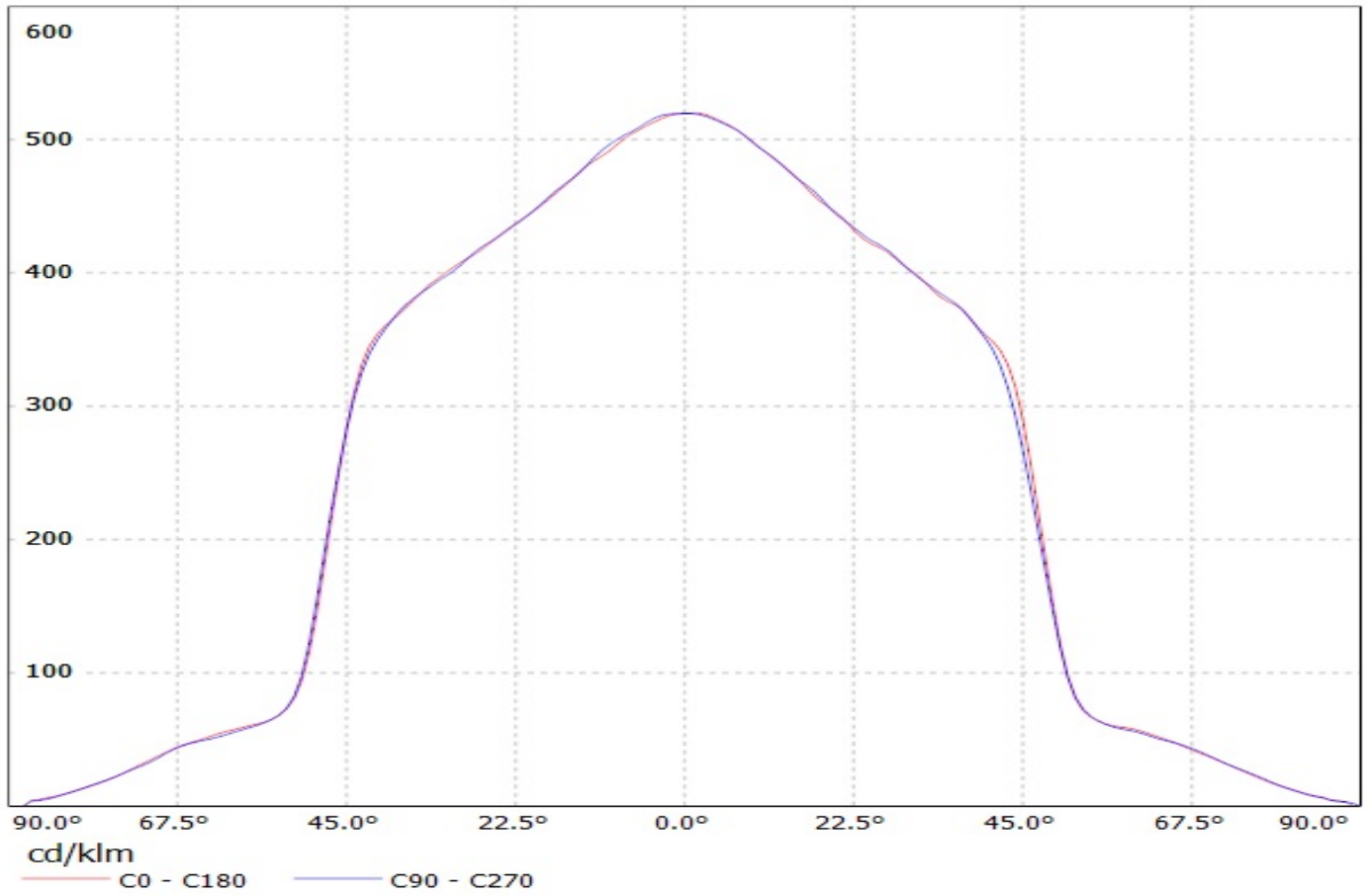

Luminaire: LEDiL Oy F13838_ANGELINA-XW_(Fortimo LED SLM L13 G4)
Lamps: 1 x Fortimo LED SLM L13 G4_1110.38lm@250mA_P=8.38454W_I=0.2498A

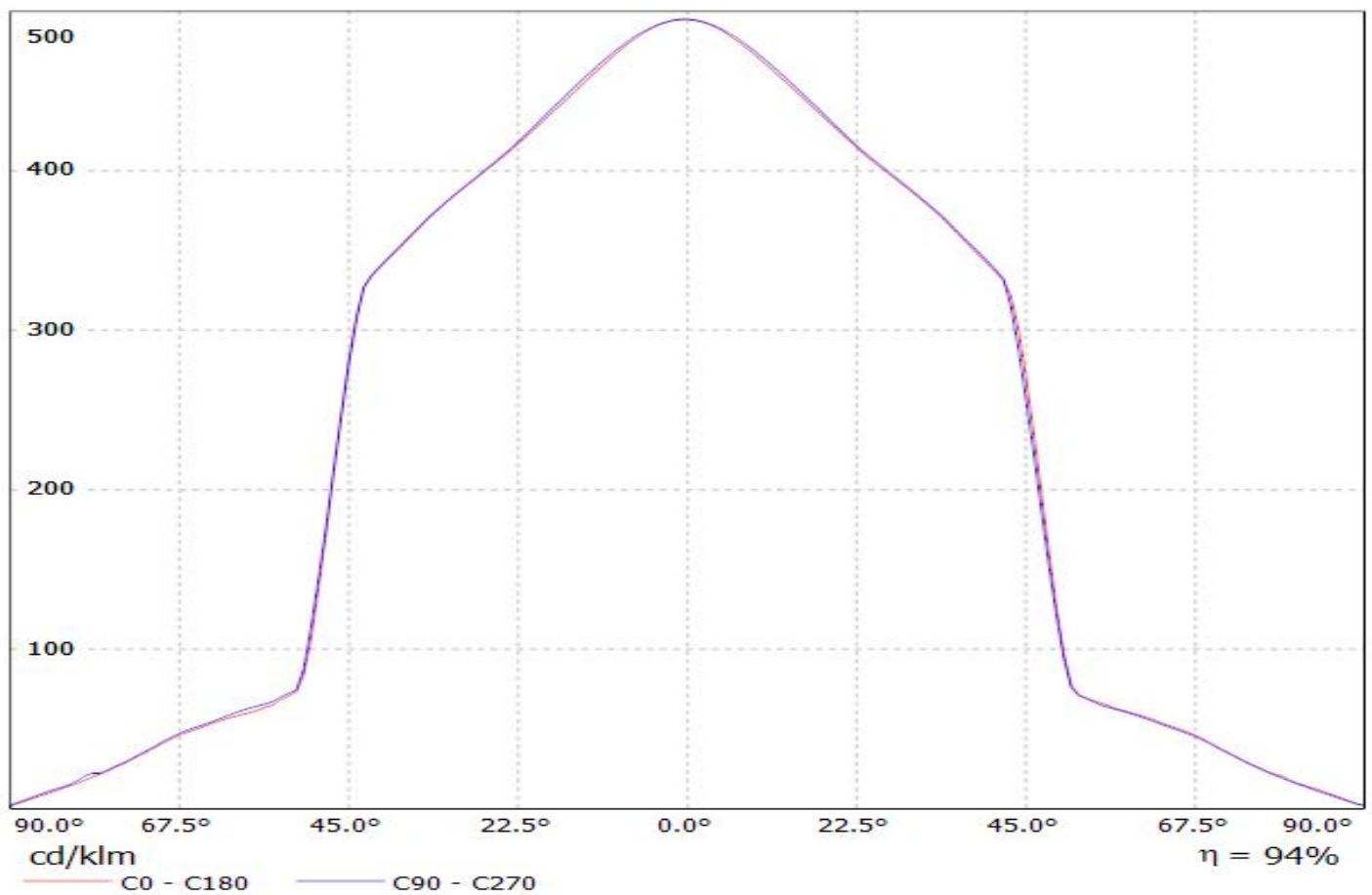

Luminaire: LEDiL Oy F13838_ANGELINA-XW_(Fortimo LED SLM 1100 lm 830 L9 G4)
Lamps: 1 x Fortimo LED SLM 1100 lm 830 L9 G4_1021.27lm@250mA_P=9.2431W_I=0.2498A

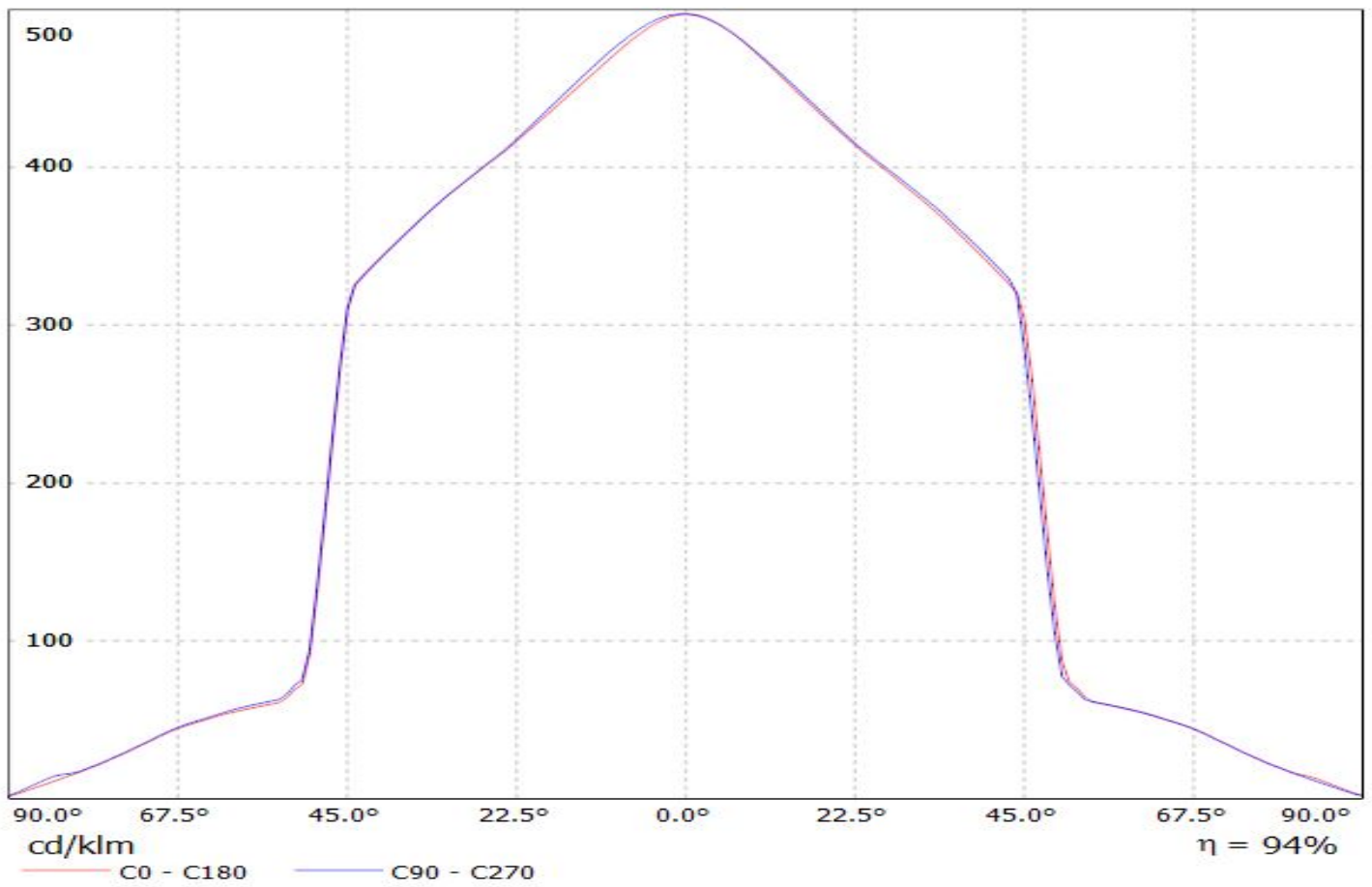

Luminaire: LEDiL Oy F13838_ANGELINA-XW_(WU-M-484)

Lamps: 1 x Vossloh_Schwabe-WU-M-484_(WU-M-484-830)_657.125lm@250mA_P=5.59976W_I=249.9mA

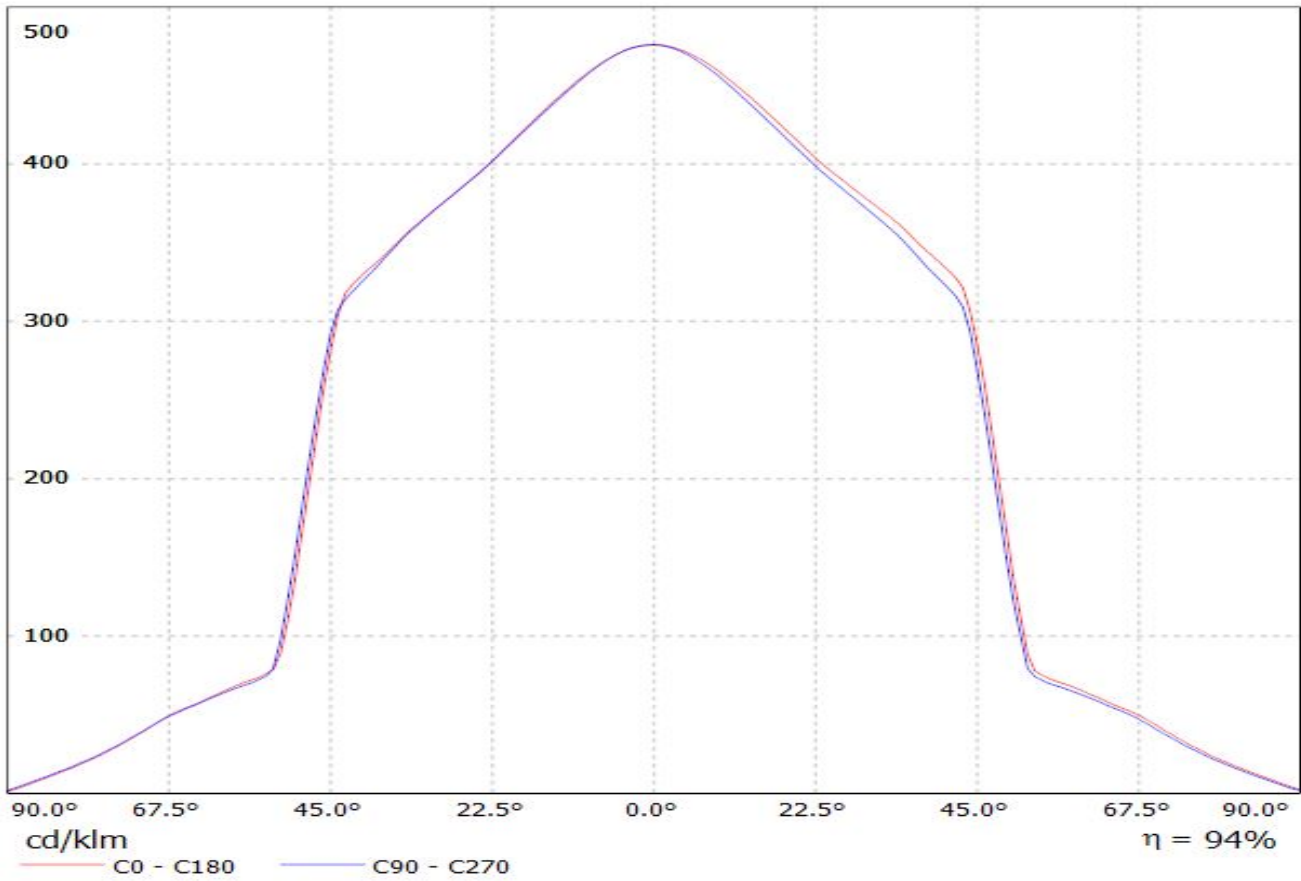

Luminaire: LEDiL Oy F13838_ANGELINA-XW_(WU-M-485)

Lamps: 1 x Vossloh_Schwabe-WU-M-485_(WU-M-485-830)_1209.62lm@250mA_P=8.43849W_I=249.8mA

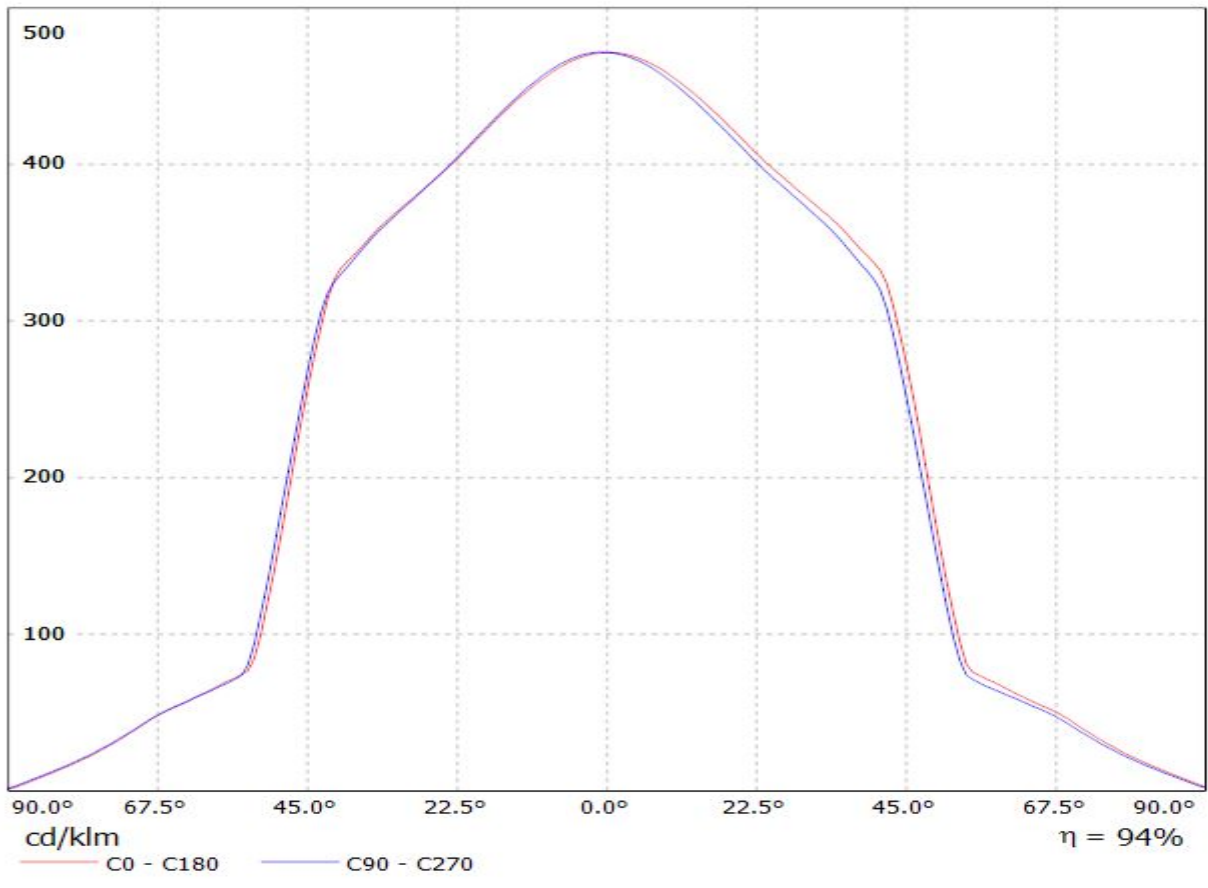

Luminaire: LEDiL Oy F13838_ANGELINA-XW_(CXM-14)
Lamps: 1 x LUMINUS_CXM-14_1114.36lm@250mA_P=8.36106W_I=249.8mA

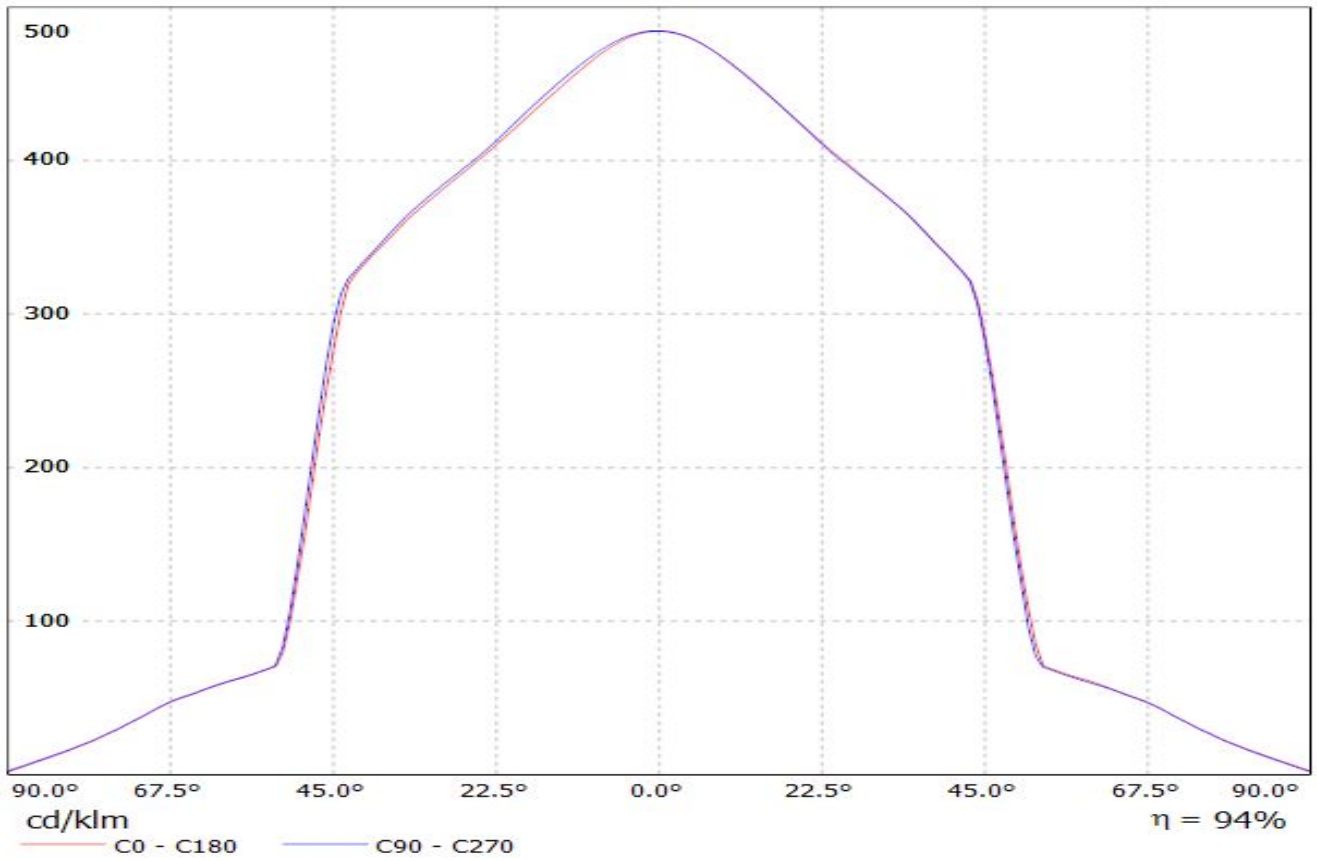

Luminaire: LEDiL Oy F13838_ANGELINA-XW_(WU-M-464) Eff.94.1%
Lamps: 1 x VOSSLOH_WU-M-464-827_1452.09lm@250mA_P=11.7139W_I=249.8mA

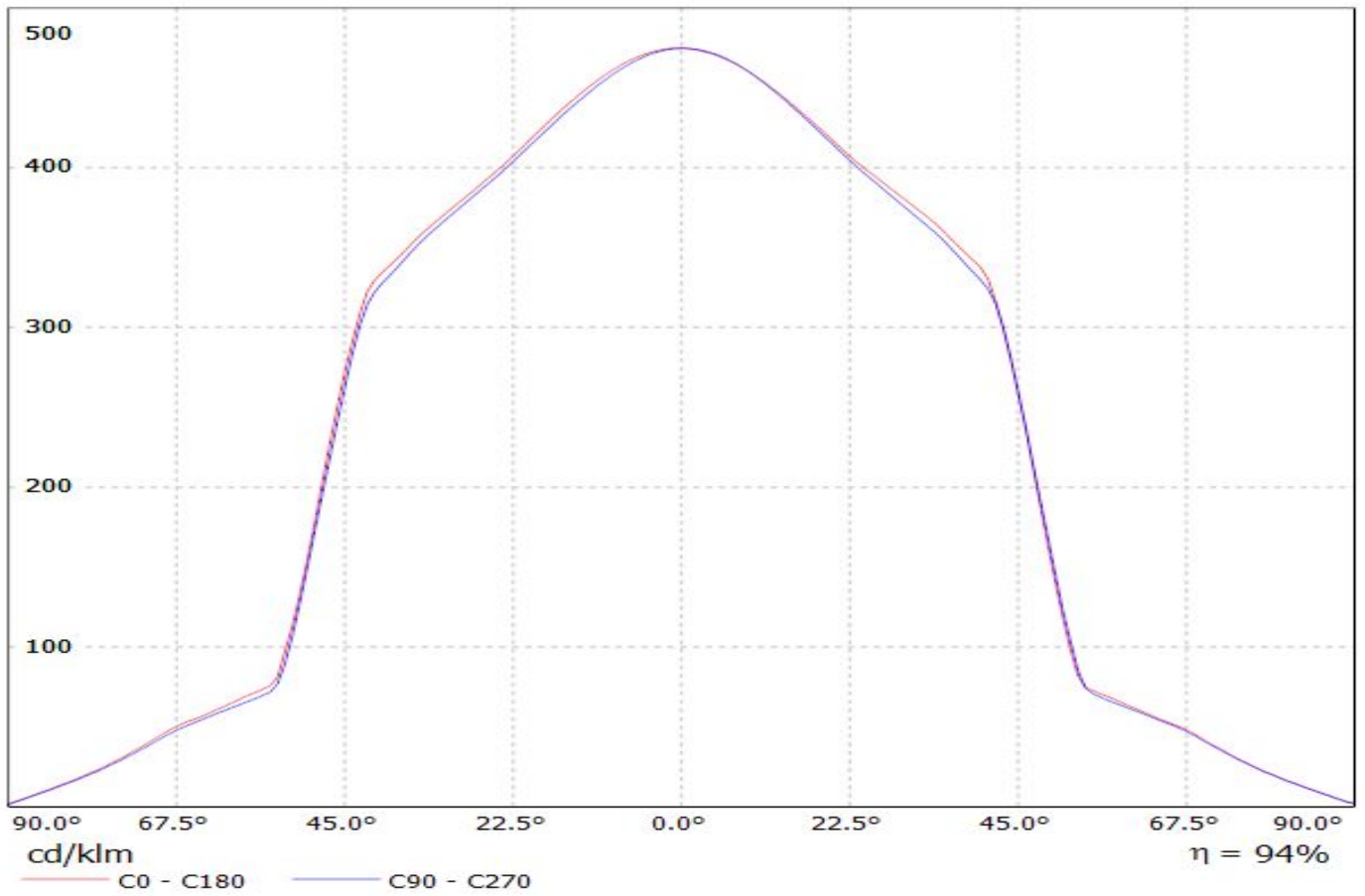

Ledil F13838_ANGELINA-XW_(CLU720) / LDC (Linear)

Luminaire: Ledil F13838_ANGELINA-XW_(CLU720)
Lamps: 1 x CITIZEN_CLU720_(CLU720-1206B8-273M2)
_1340.38lm@250mA_CCT=2700K_P=8.35W_I=0.25A

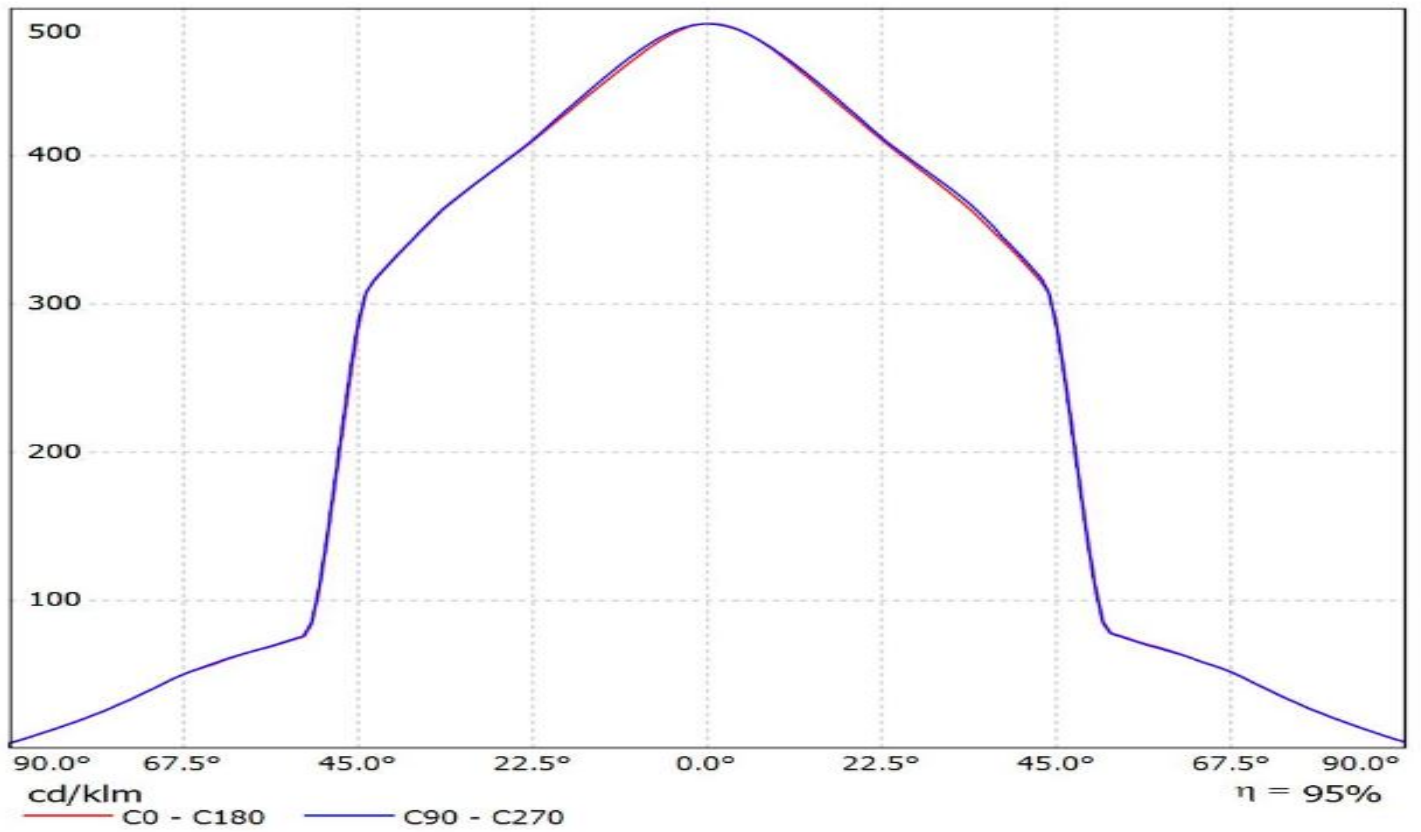

Luminaire: LEDiL Oy F13838_ANGELINA-XW_(NSBxL121A)
Lamps: 1 x Nichia_NSBxL121A_935.409lm@250mA_P=7.57219W_I=249.8mA

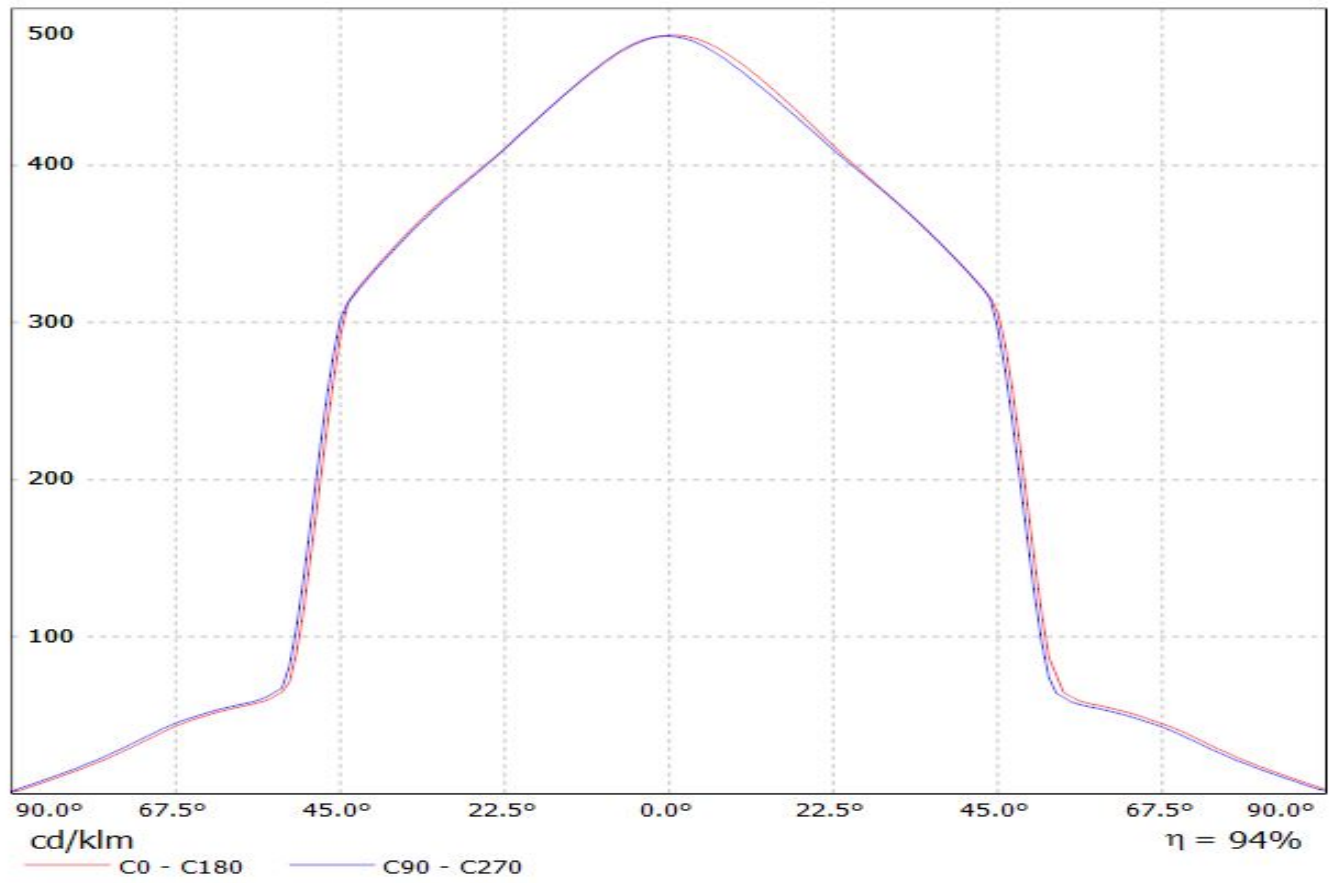

Luminaire: LEDil Oy F13838_ANGELINA-XW_(NFDxJ130B)

Lamps: 1 x Nichia NFDxJ130B (SM403G6450R8000) 1410.46lm @ 250mA P=8.9W I=250mA

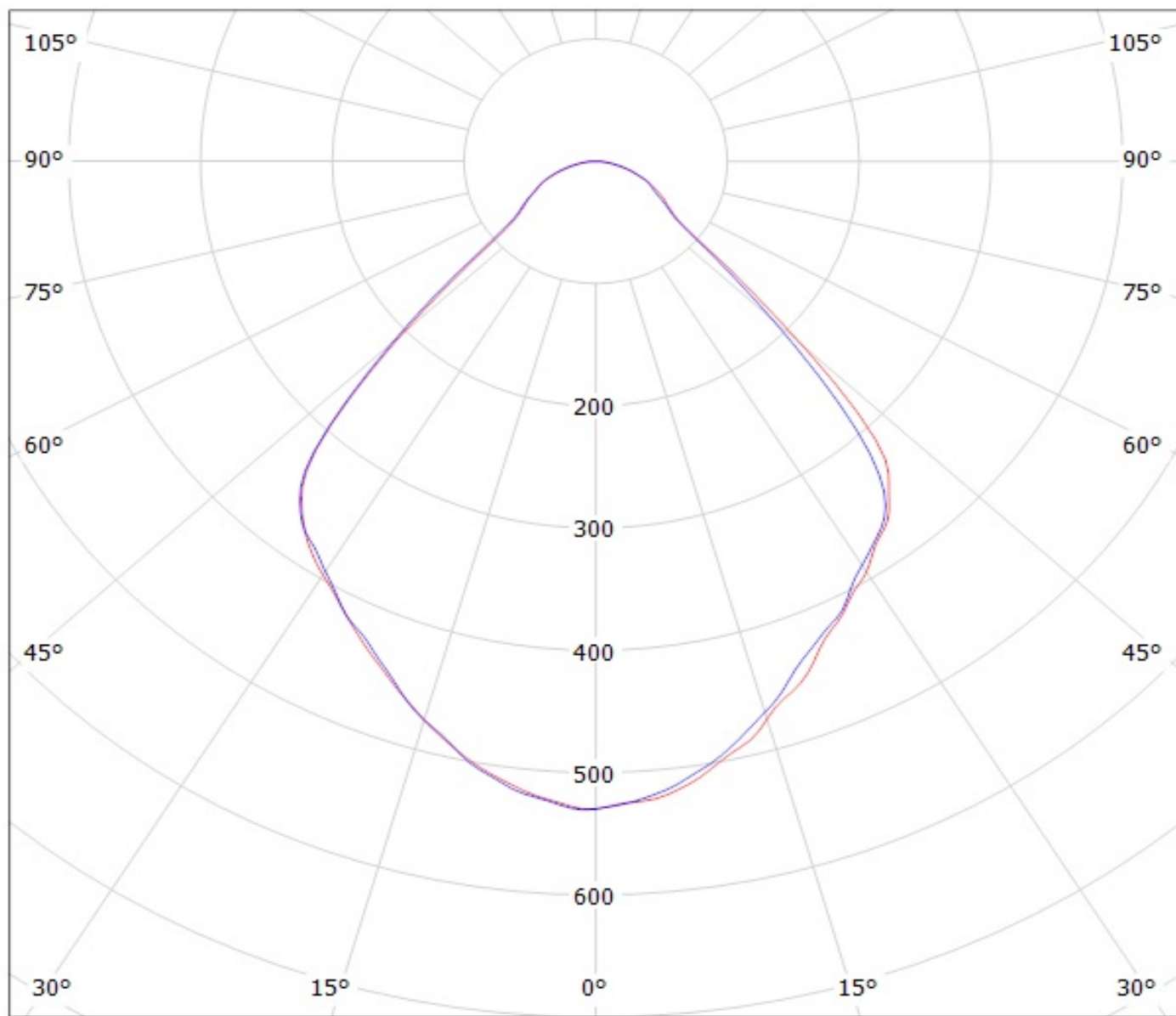

cd/klm

— C0 - C180

— C90 - C270

Luminaire: LEDiL Oy F13838_ANGELINA-XW_(LEP-2000-827-C-AC)
Lamps: 1 x OSRAM PrevaLED Core AC (LEP-2000-827-C-AC)

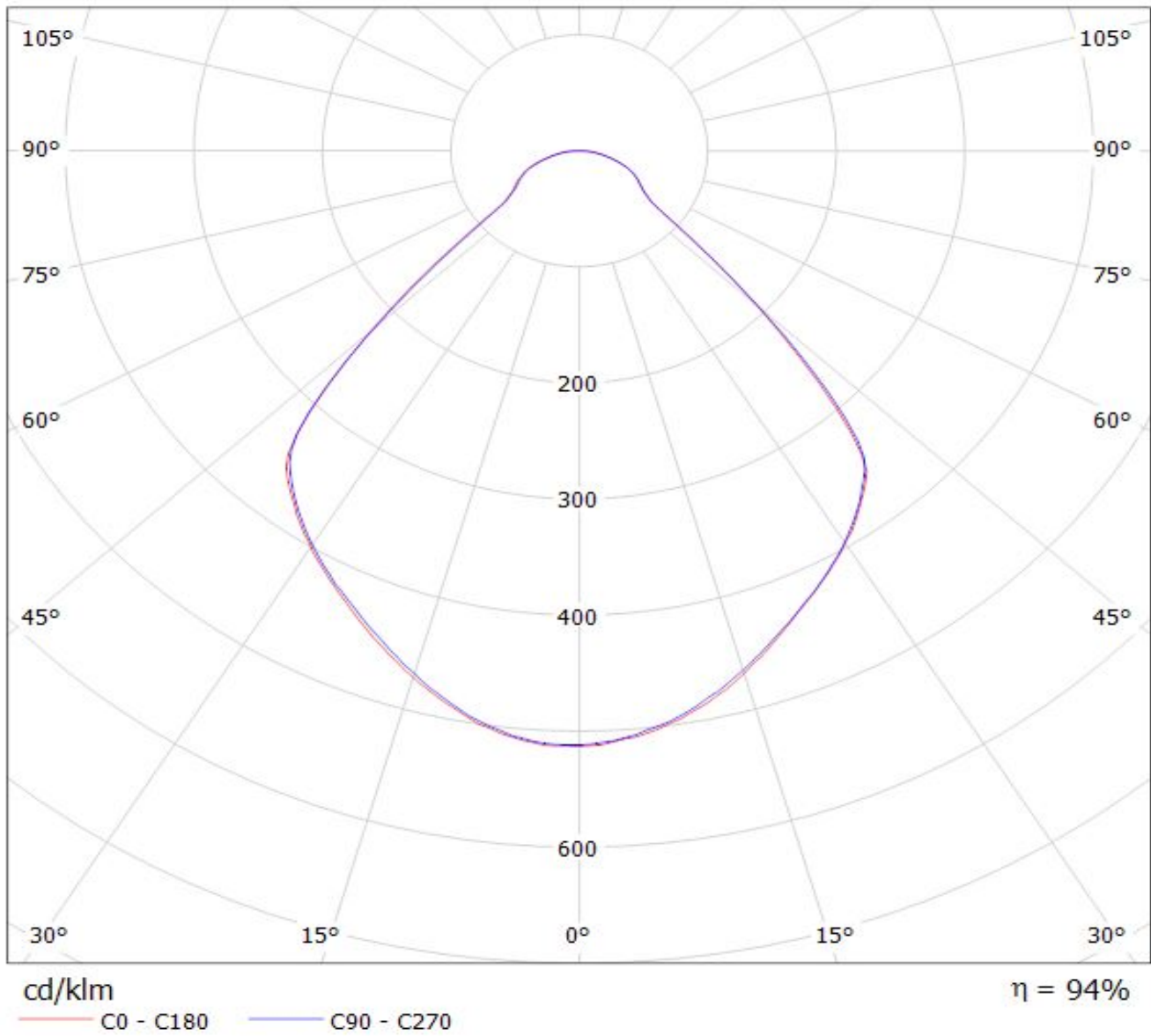

Luminaire: LEDiL Oy F13838_ANGELINA-XW_(CLL030)

Lamps: 1 x Citizen_CLL030_(CLL030-1206A1-303M1A2)_971.531lm@250mA_P=8.42026W_I=249.8mA

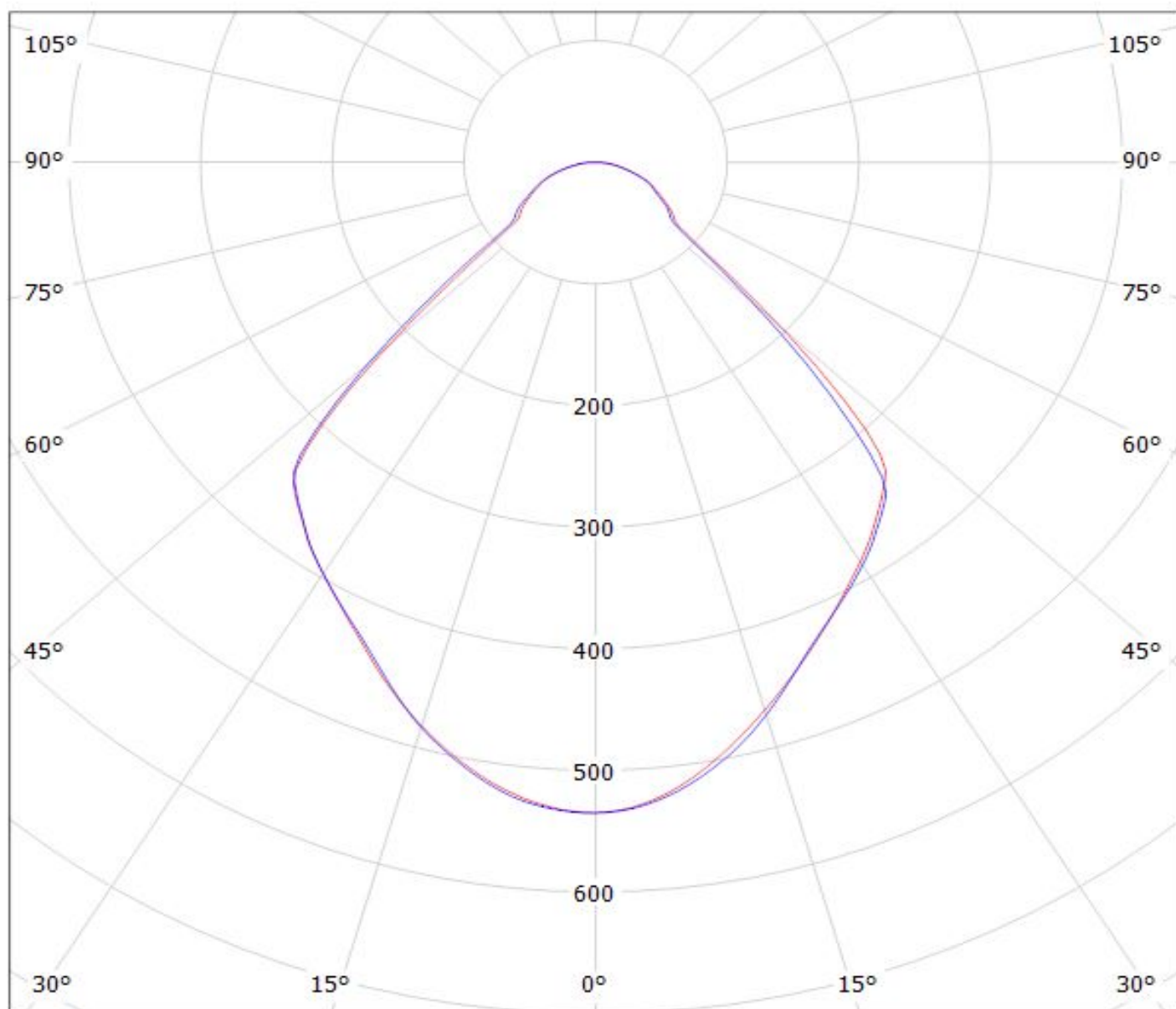

cd/klm

— C0 - C180 — C90 - C270

$\eta = 94\%$

Luminaire: Ledil F13838_ANGELINA-XW_(CLU720)
Lamps: 1 x CITIZEN_CLU720_(CLU720-1206B8-273M2)
_1337.27lm@250mA_CCT=2700K_P=8.35W_I=0.25A

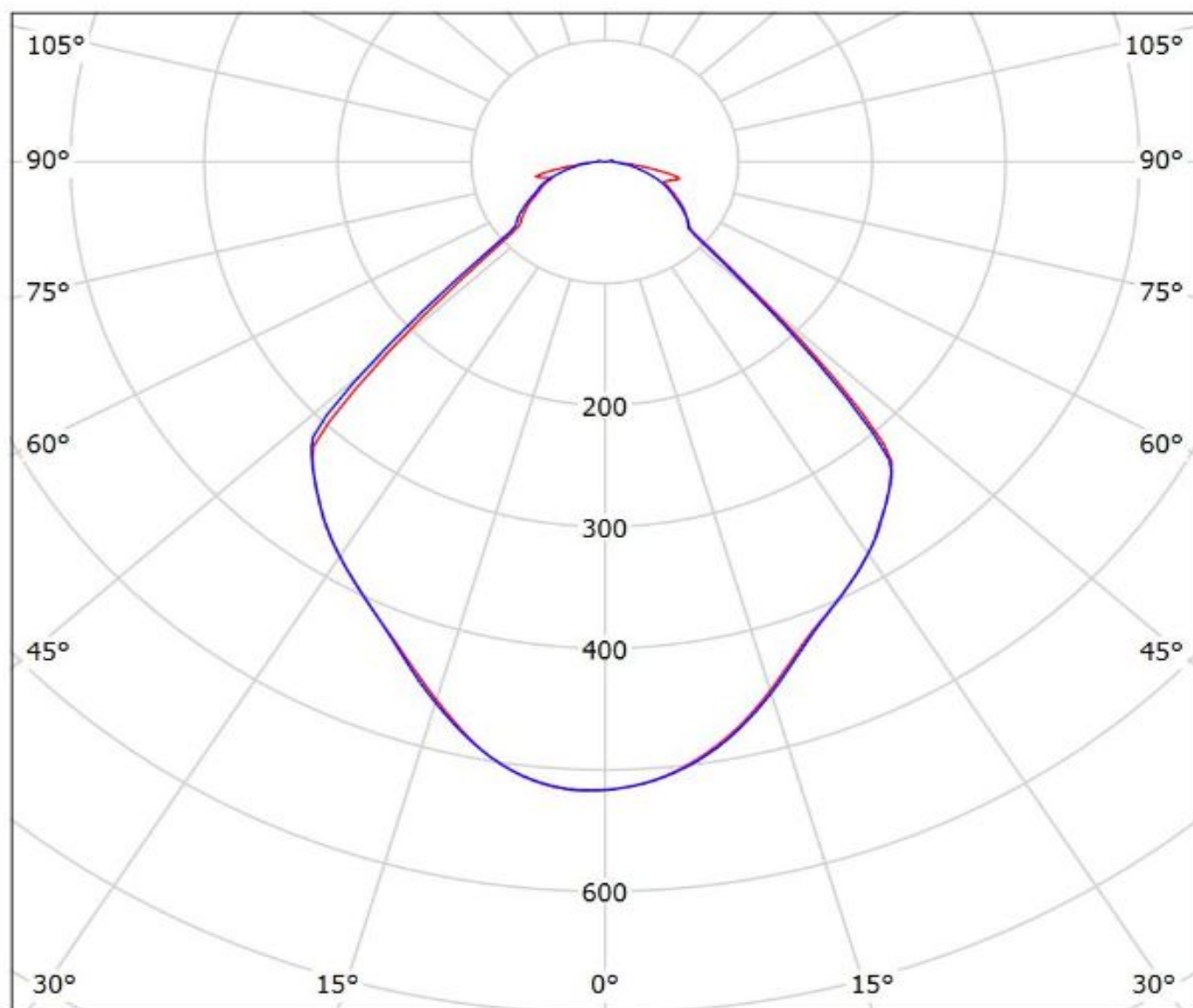

cd/klm

— C0 - C180 — C90 - C270

$\eta = 95\%$

Luminaire: LEDiL Oy F13838_ANGELINA-XW_(SLM_4500) Eff.94.3%

Lamps: 1 x Philips_FORTIMO_SLM_4500_1139.88lm@250mA_P=10.7416W_I=249.8mA

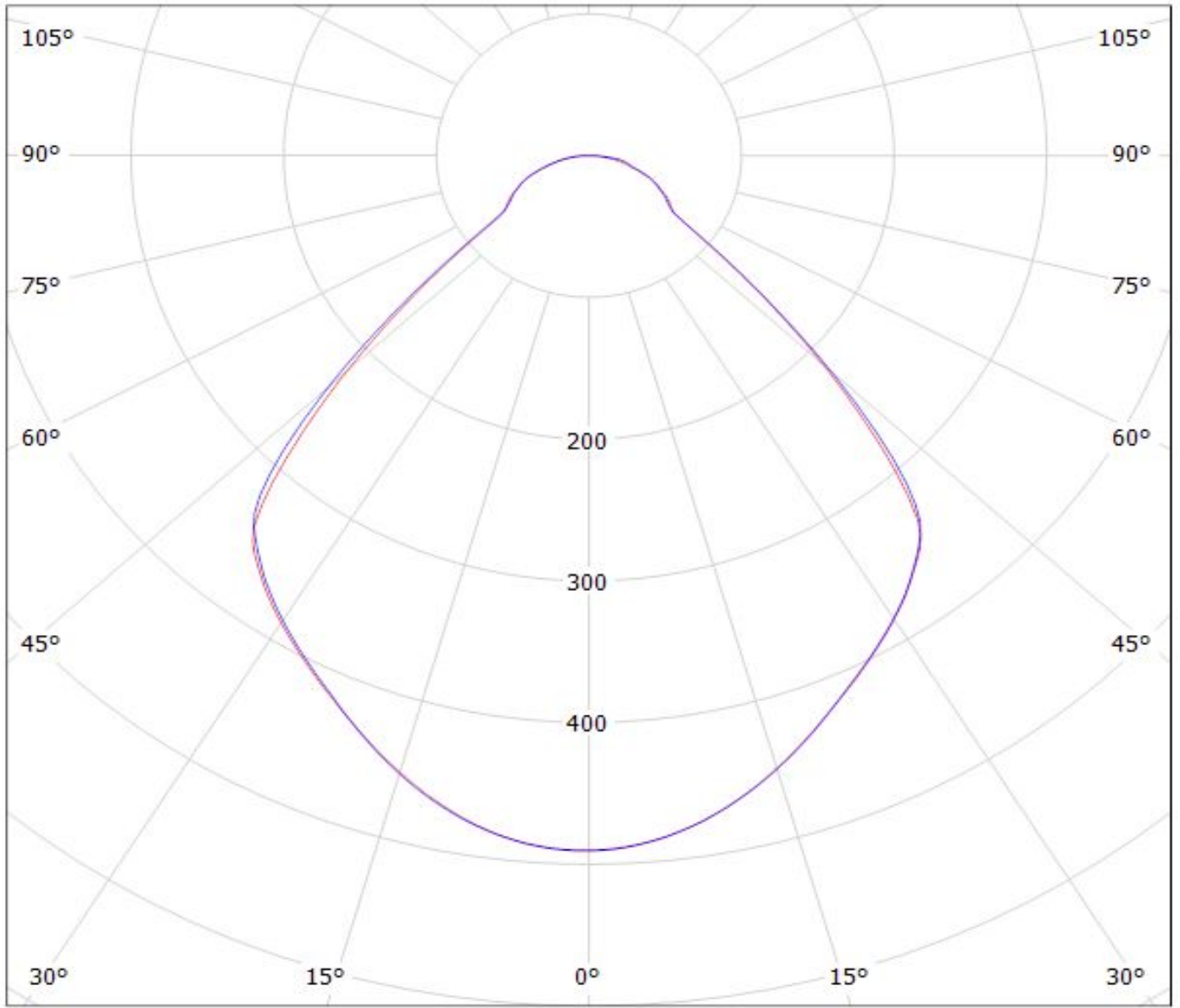

cd/klm

η = 94%

— C0 - C180

— C90 - C270

Luminaire: LEDiL Oy F13838_ANGELINA-XW_(LES26) Eff.94.4%

Lamps: 1 x Tridonic_STARK_SLE_G2_LES26_1048.24lm@250mA_P=8.04403W_I=249.9mA

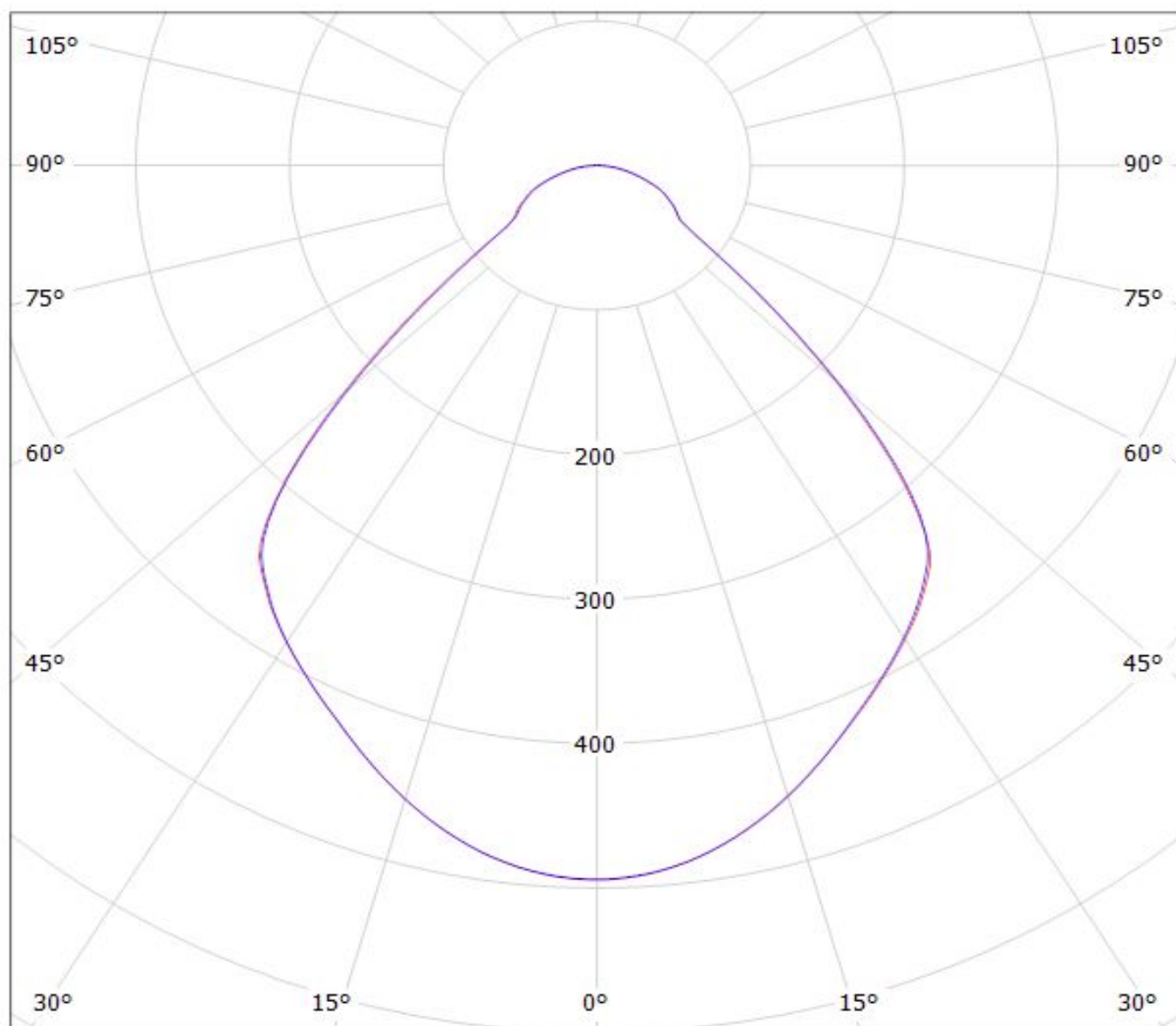

cd/klm

— C0 - C180

— C90 - C270

$\eta = 94\%$

Luminaire: LEDiL Oy F13838_ANGELINA-XW_(LES23) Eff.94.1%

Lamps: 1 x Tridonic_STARK_SLE_G2_LES23_955.501lm@250mA_P=8.34207W_I=249.8mA

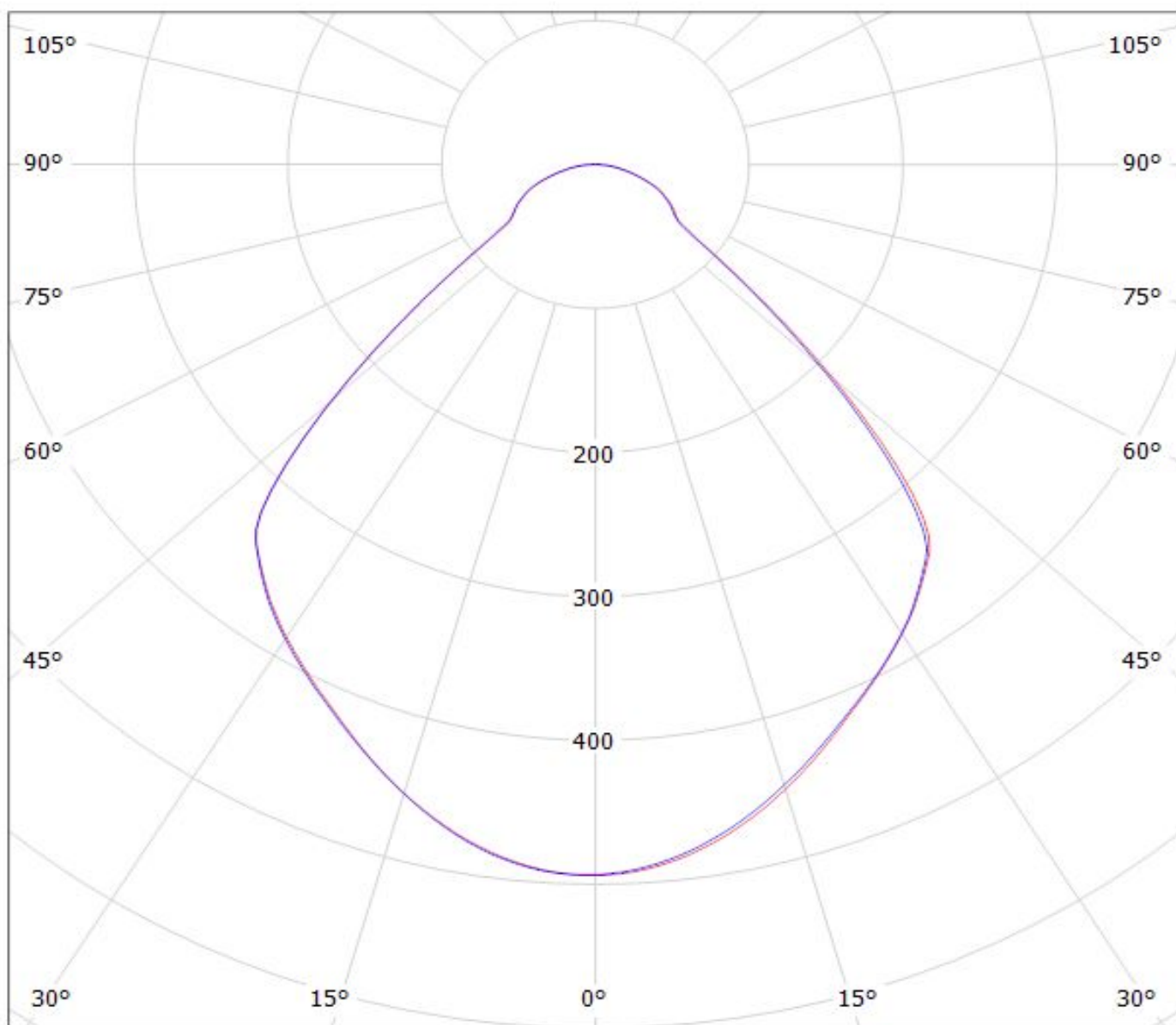

cd/klm

$\eta = 94\%$

— C0 - C180

— C90 - C270

Luminaire: LEDiL Oy F13838_ANGELINA-XW_(LEP-800-827-C-AC)

Lamps: 1 x OSRAM PrevaLED Core AC (LEP-800-827-C-AC) 910lm@60mA U:230V P:14W

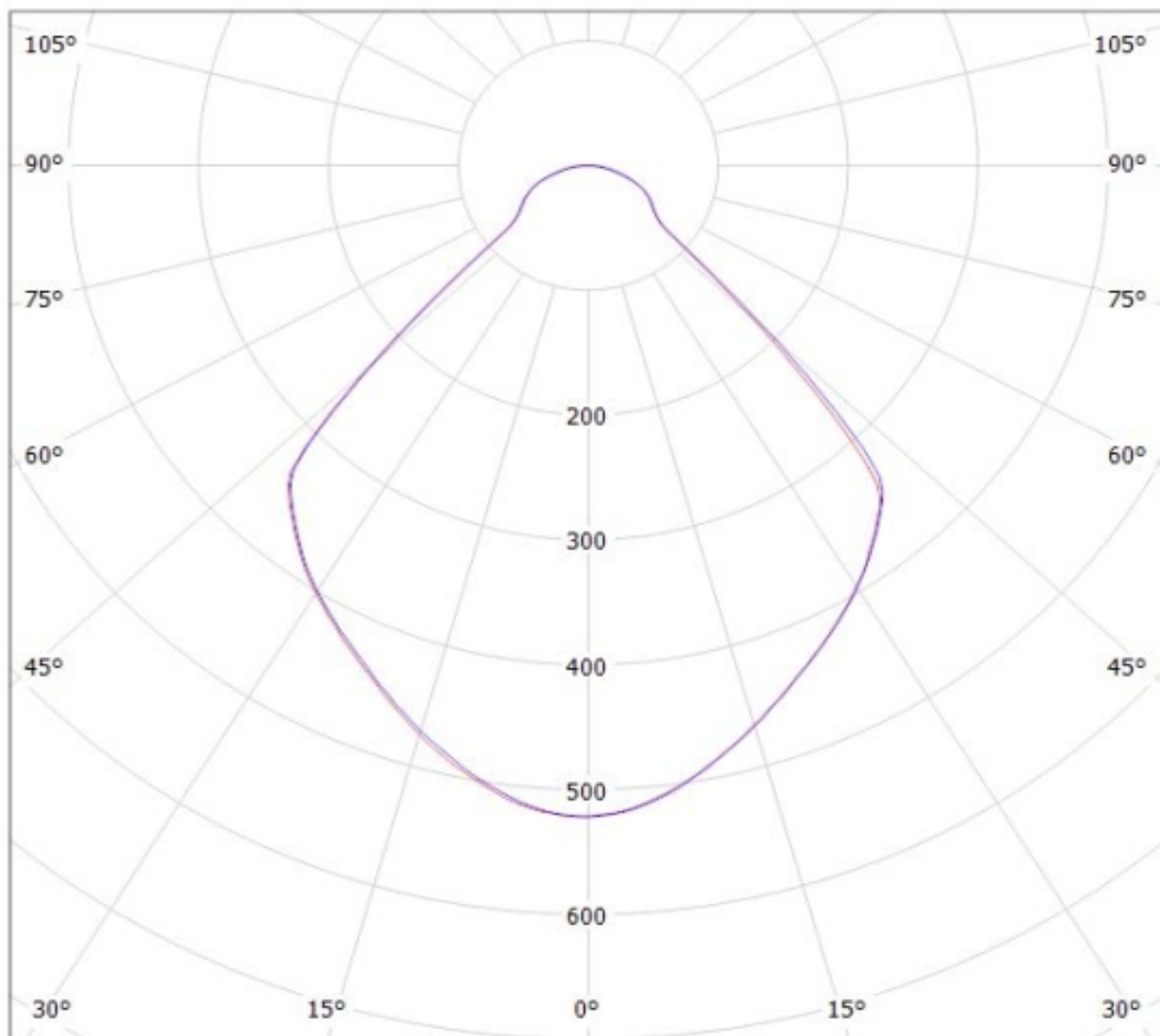

cd/klm

— C0 - C180

— C90 - C270

$\eta = 94\%$

Luminaire: LEDiL Oy F13838_ANGELINA-XW_(PrevaLED_Z4) Eff: 94%

Lamps: 1 x Osram_PrevaLED_CORE_Z4_(PL-CORE-3000-830-Z4)_1433.3lm@250mA_P=10.7652W_I=249.9mA

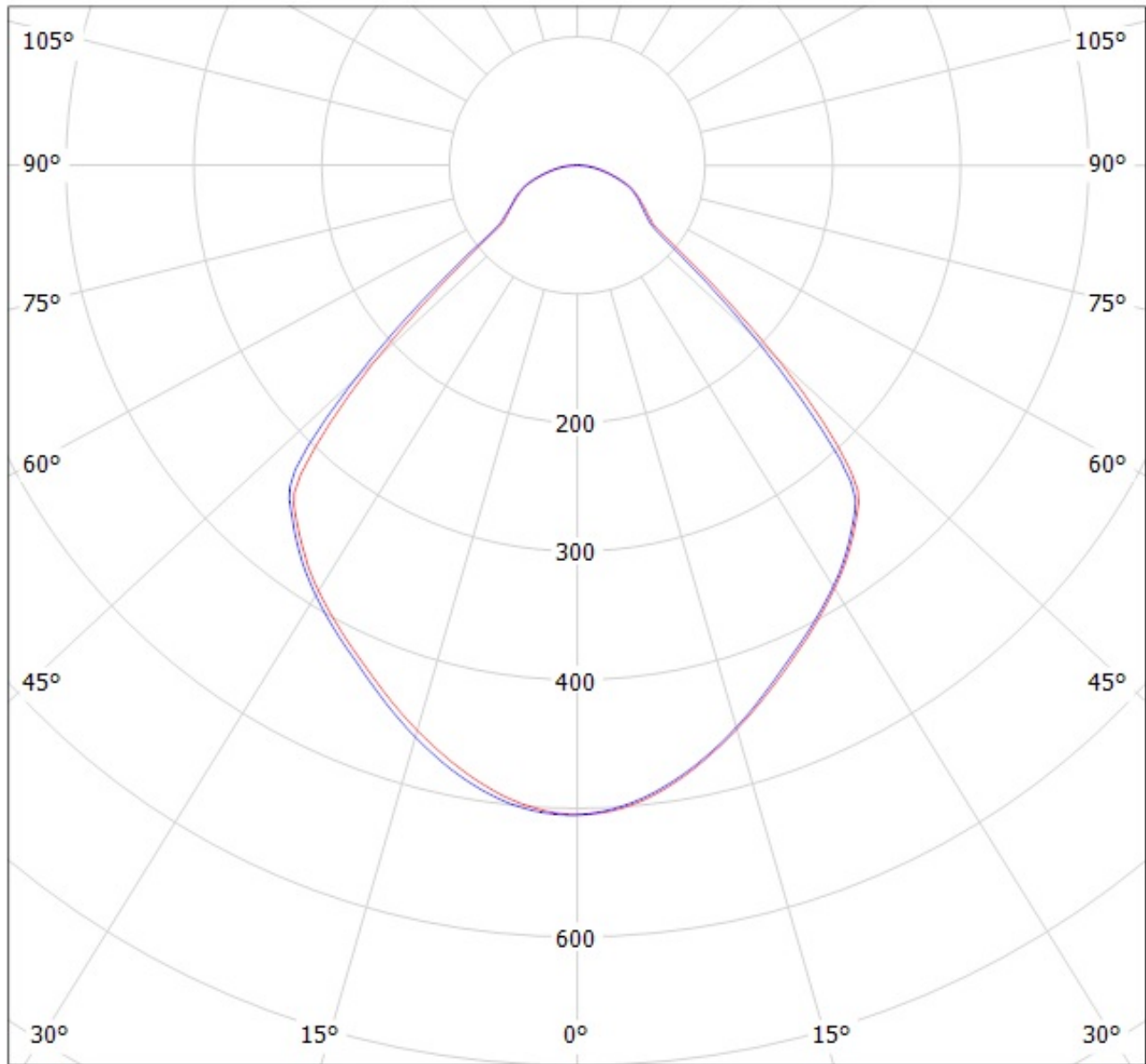

cd/klm

— C0 - C180

— C90 - C270

$\eta = 94\%$

Luminaire: LEDiL Oy F13838_ANGELINA-XW_(Fortimo LED SLM L19 G4)
Lamps: 1 x Fortimo LED SLM L19 G4_1114.89lm@250mA_P=8.04906W_I=0.2498A

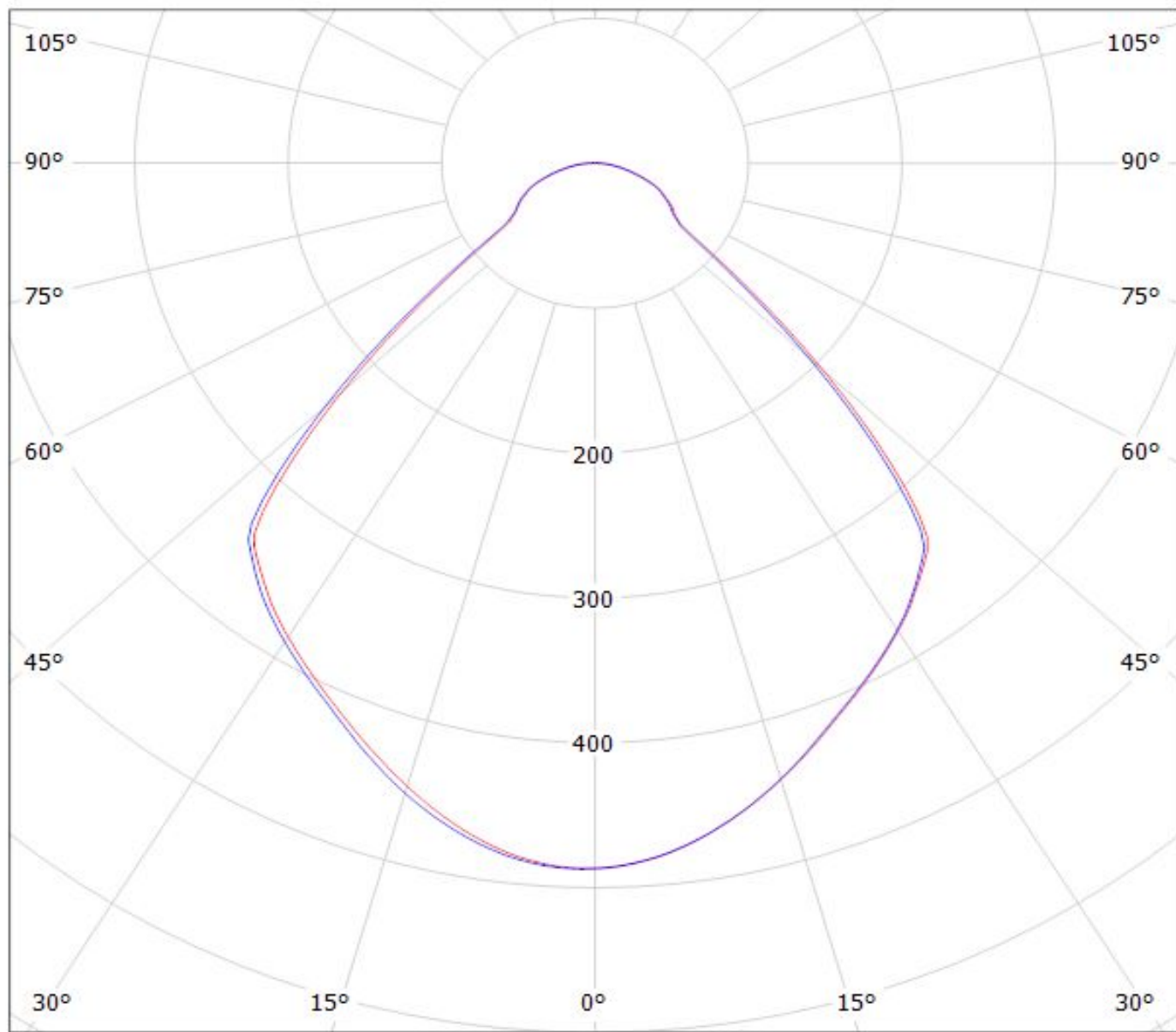

cd/klm

— C0 - C180 — C90 - C270

$\eta = 93\%$

Luminaire: LEDiL Oy F13838_ANGELINA-XW_(SLE_G4_LES23)

Lamps: 1 x Tridonic_SLE_G4_LES23_1354.57lm@250mA_P=8.18744W_I=0.2498A

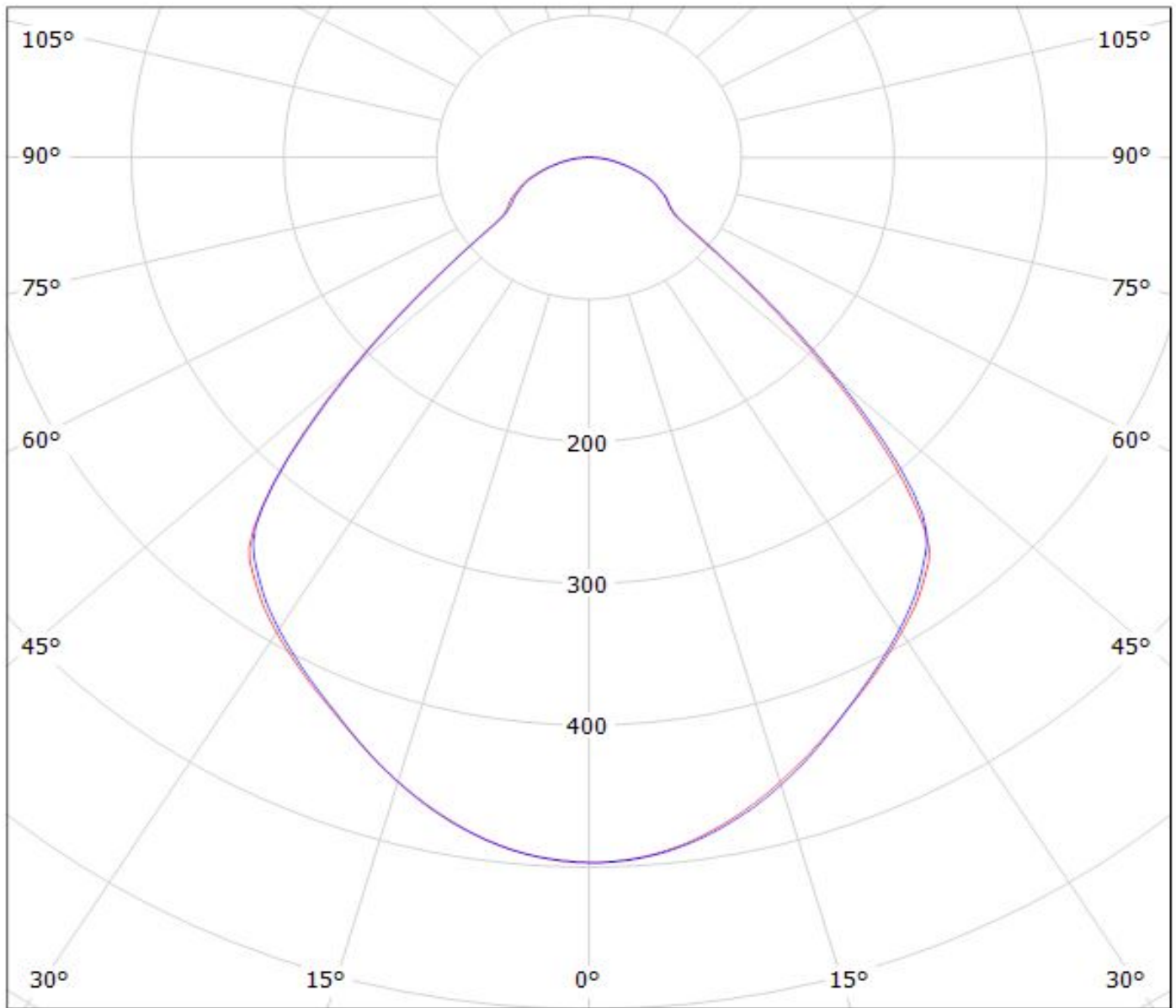

cd/klm

— C0 - C180

— C90 - C270

$\eta = 95\%$

Luminaire: LEDiL Oy F13838_ANGELINA-XW_(K16) Eff.94.0%
Lamps: 1 x Luxeon_K16_1246lm@250mA_P=10.8991W_U=249.9mA

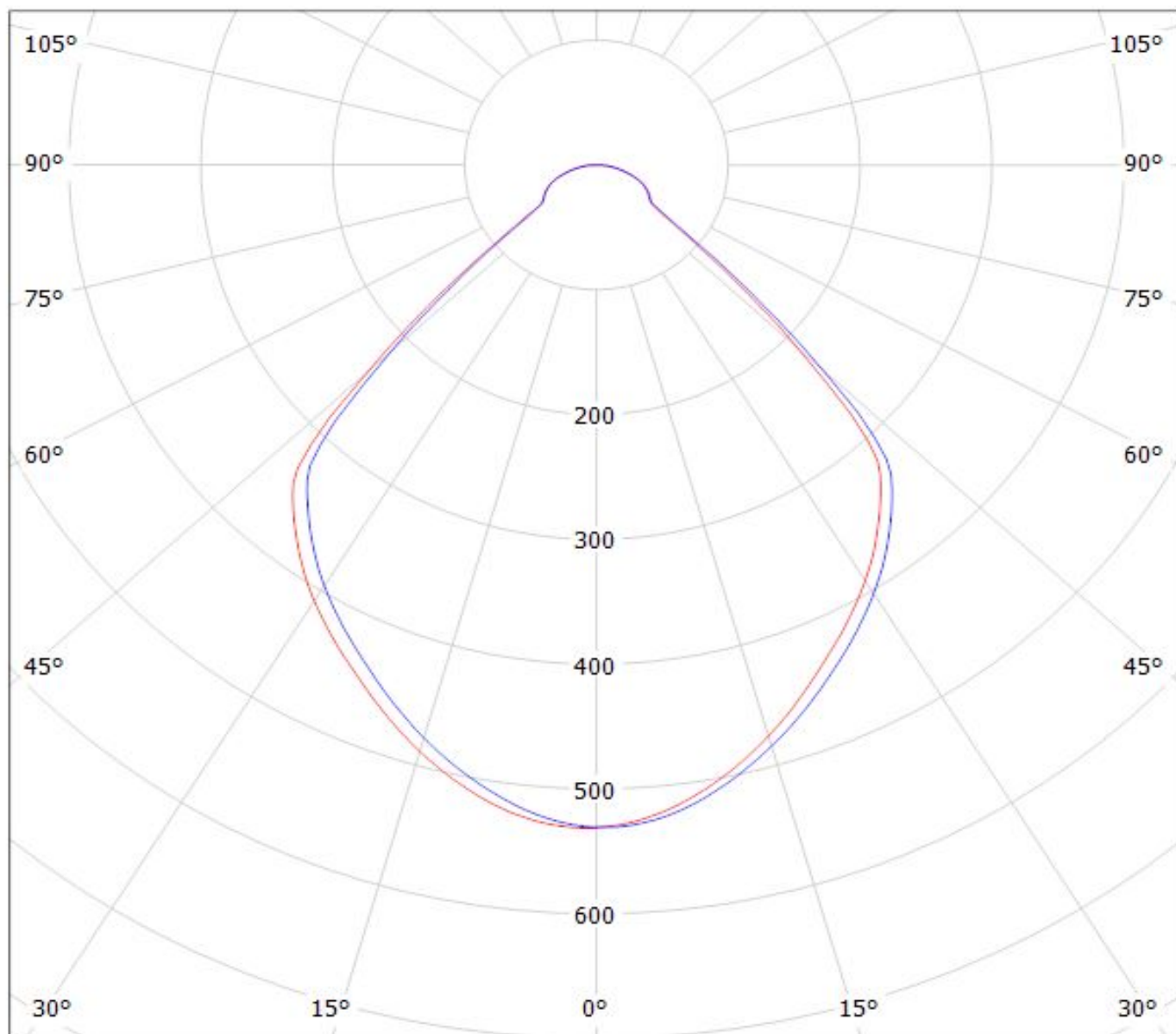

cd/klm

— C0 - C180

— C90 - C270

$\eta = 94\%$

Luminaire: LEDiL Oy F13838_ANGELINA-XW_(CXA3590)

Lamps: 1 x CREE_CXA3590_(CXA3590-30F-BD-R0H-0002)_2640.14lm@250mA_CCT=3000K_P=16.3941W_I=249.8mA

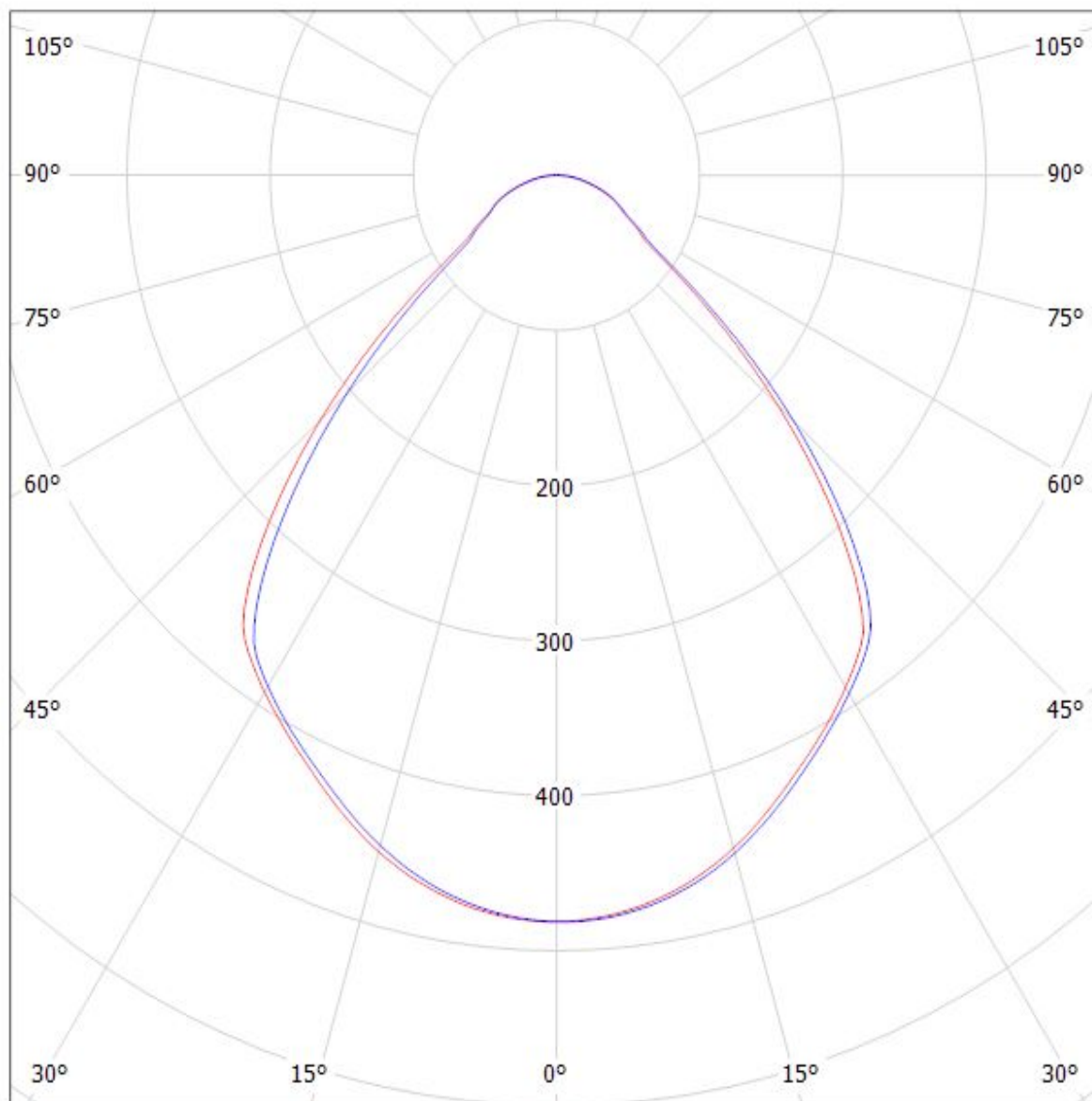

cd/klm

— C0 - C180 — C90 - C270

$\eta = 95\%$

Luminaire: LEDiL Oy F13838_ANGELINA-XW_(SLM_2000) Eff.94.1%

Lamps: 1 x Philips_FORTIMO_SLM_2000_728.985lm@250mA_P=6.244W_I=249.9W

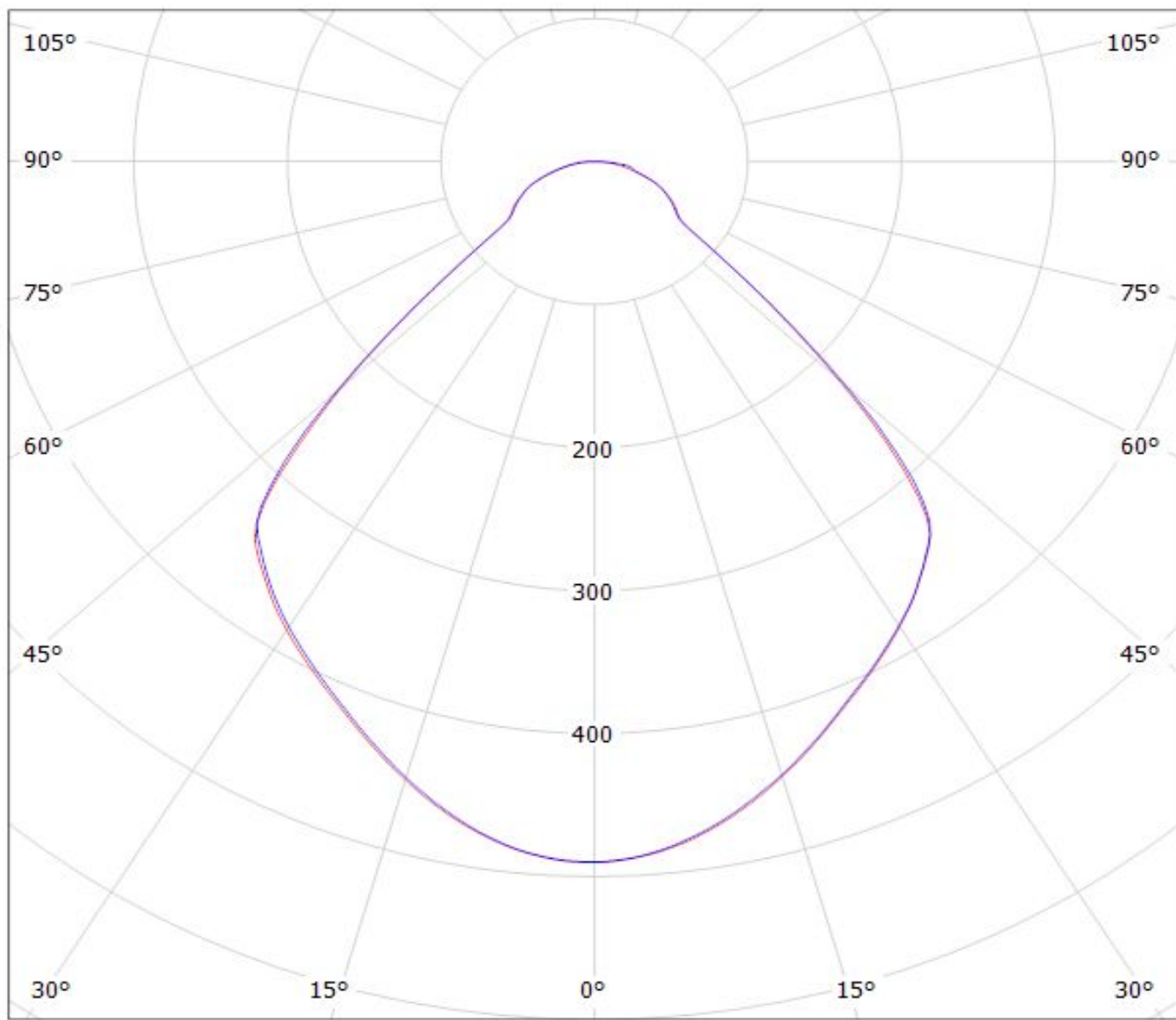

cd/klm

η = 94%

— C0 - C180

— C90 - C270

Luminaire: LEDiL Oy F13838_ANGELINA-XW_(SLM_3000) Eff.94.2%

Lamps: 1 x Philips_FORTIMO_SLM_3000_1066.81lm@250mA_P=8.8817W_I=249.9mA

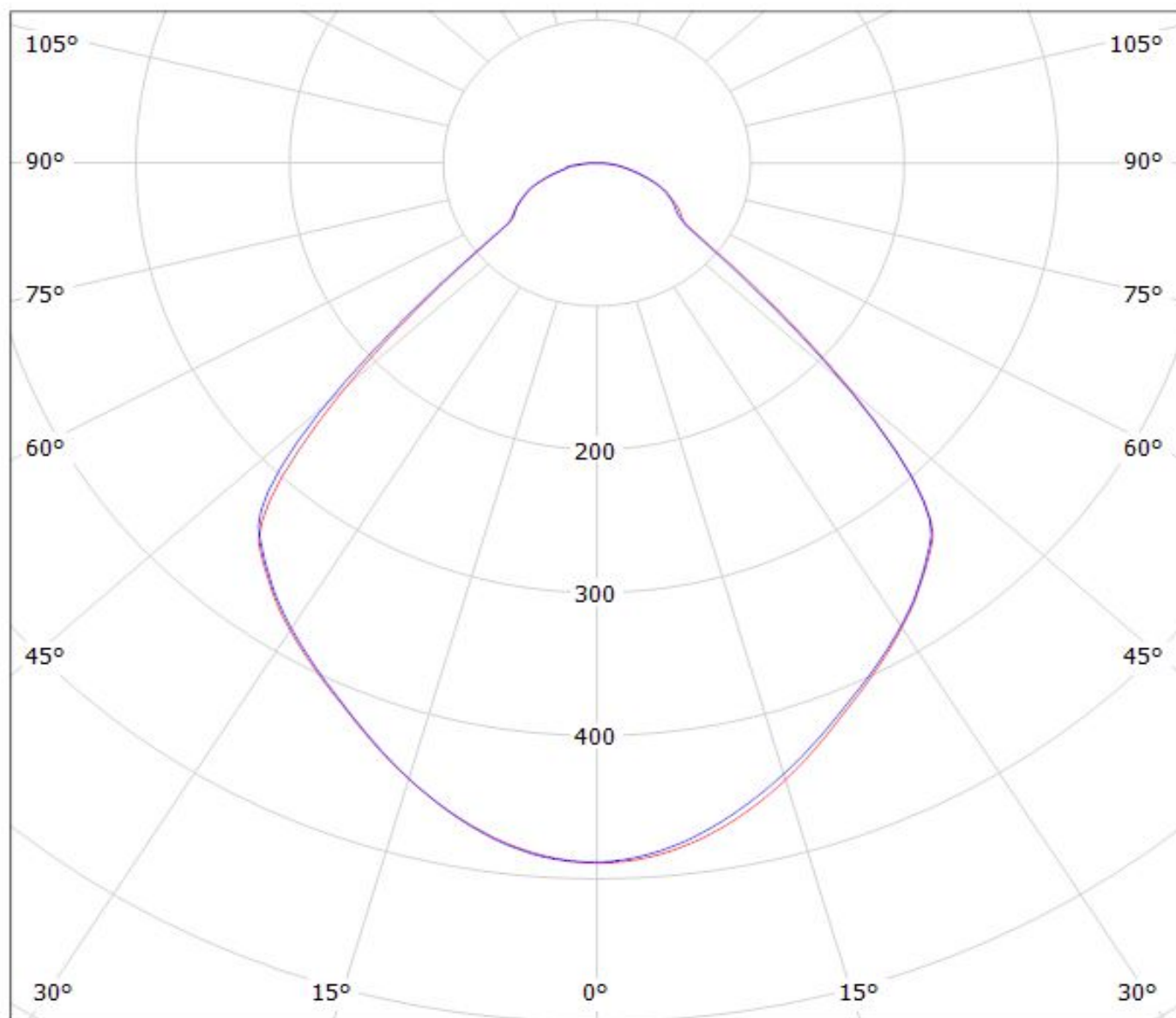

cd/klm

— C0 - C180

— C90 - C270

$\eta = 94\%$

Luminaire: LEDiL Oy F13838_ANGELINA-XW_(LES19) Eff.94.4%

Lamps: 1 x Tridonic_STARK_SLE_G2_LES19_946.117lm@250mA_P=8.43263W_I=249.9mA

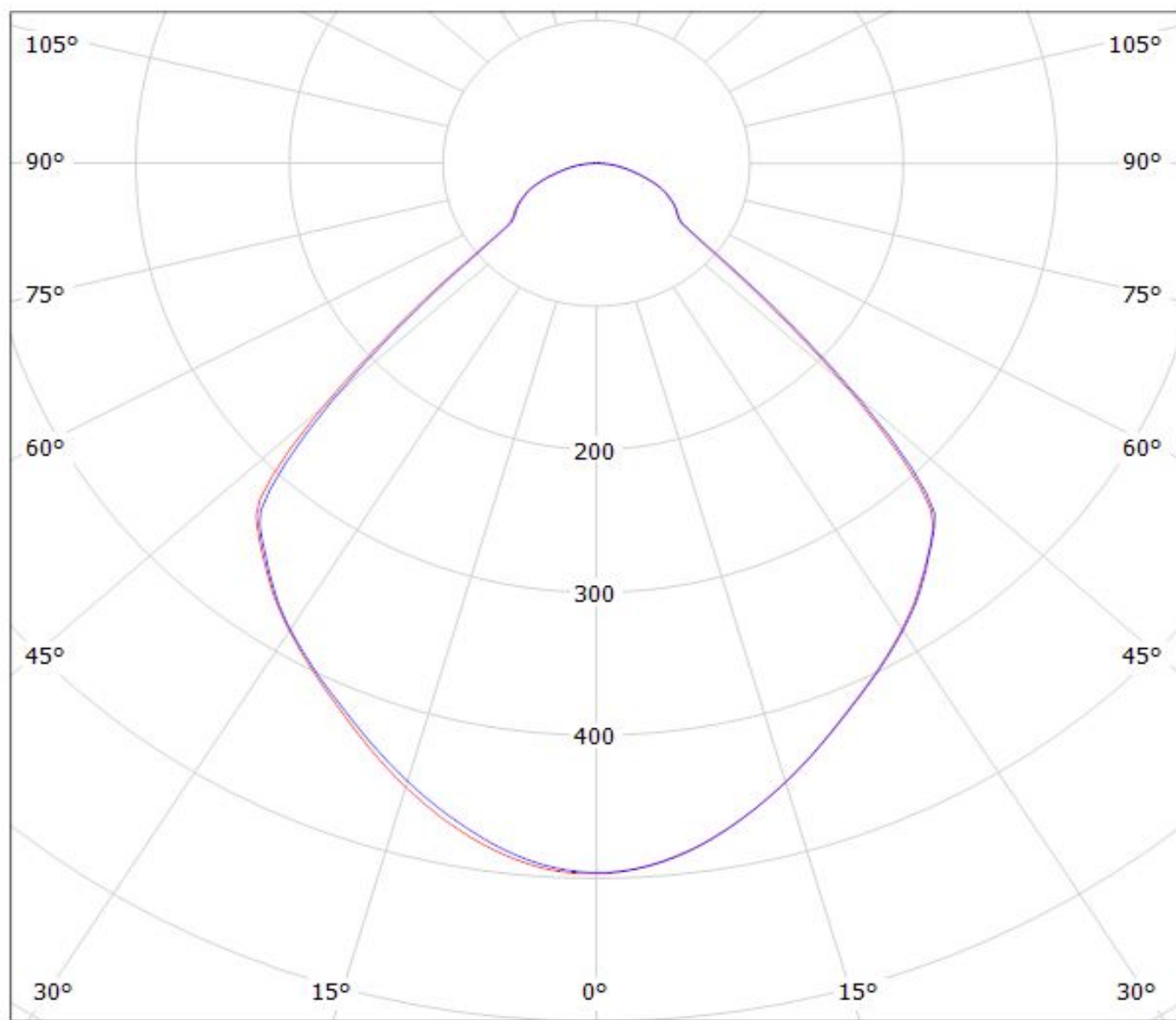

cd/klm

— C0 - C180

— C90 - C270

$\eta = 94\%$

Luminaire: LEDiL Oy F13402_ANGELINA-W_(SOLERIQ_S19_&_TE_2213407-2)

Lamps: 1 x OSRAM_SOLERIQ_S19_(GW_KAHJB1.EM)_1393.62lm@250mA_CCT=3000K_P=10.5683W_I=249.8mA

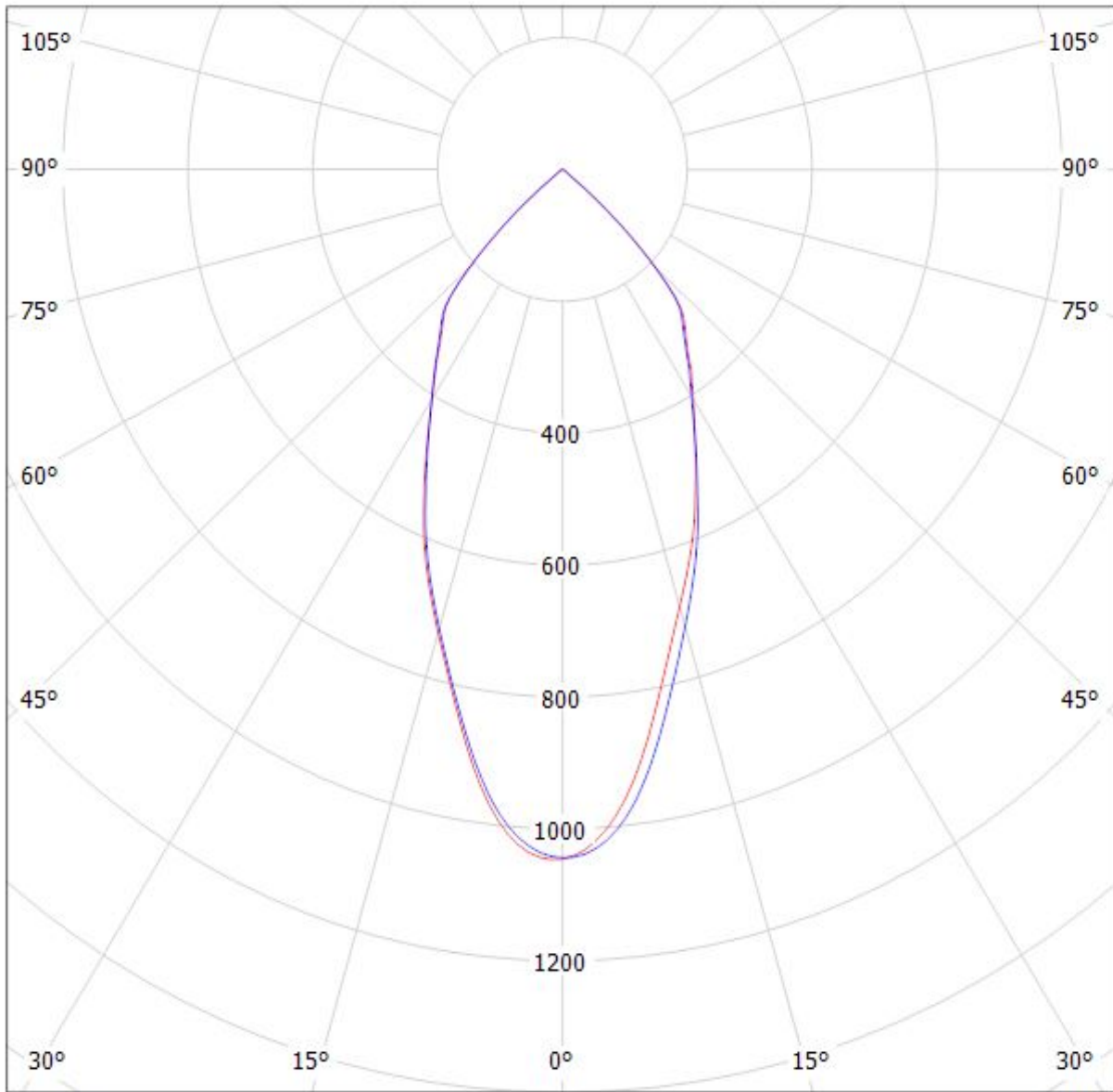

cd/klm

— C0 - C180

— C90 - C270

$\eta = 93\%$

Luminaire: LEDiL Oy F13838_ANGELINA-XW_(Fortimo LED SLM L15 G4)
Lamps: 1 x Fortimo LED SLM L15 G4_1116.47lm@250mA_P=8.21168W_I=0.2498A

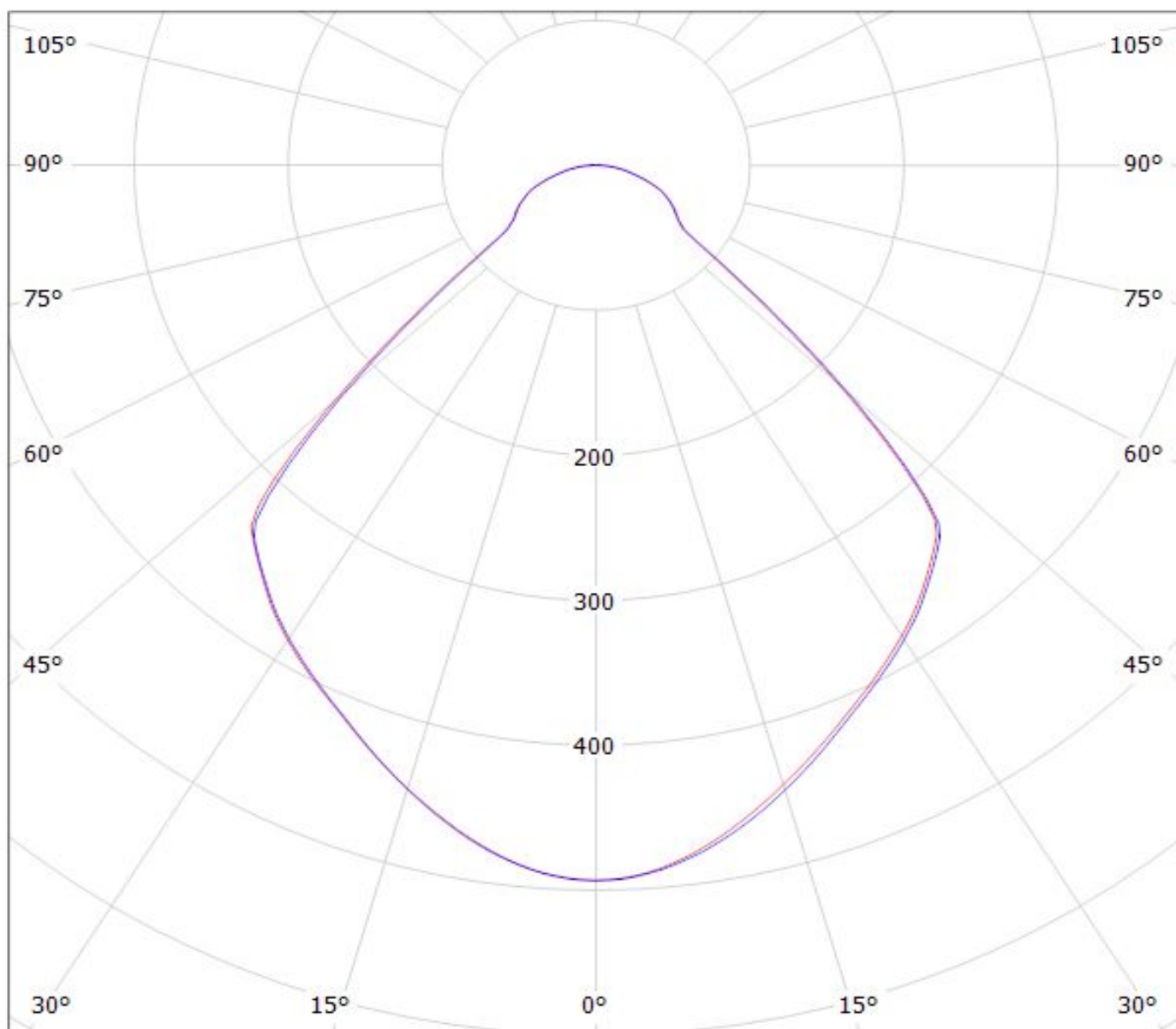

cd/klm

— C0 - C180 — C90 - C270

$\eta = 94\%$

Luminaire: LEDiL Oy F13838_ANGELINA-XW_(SLE GEN4 LES19)

Lamps: 1 x SLE GEN4 LES19_1226.28lm@250mA_P=8.21367W_I=0.2498A

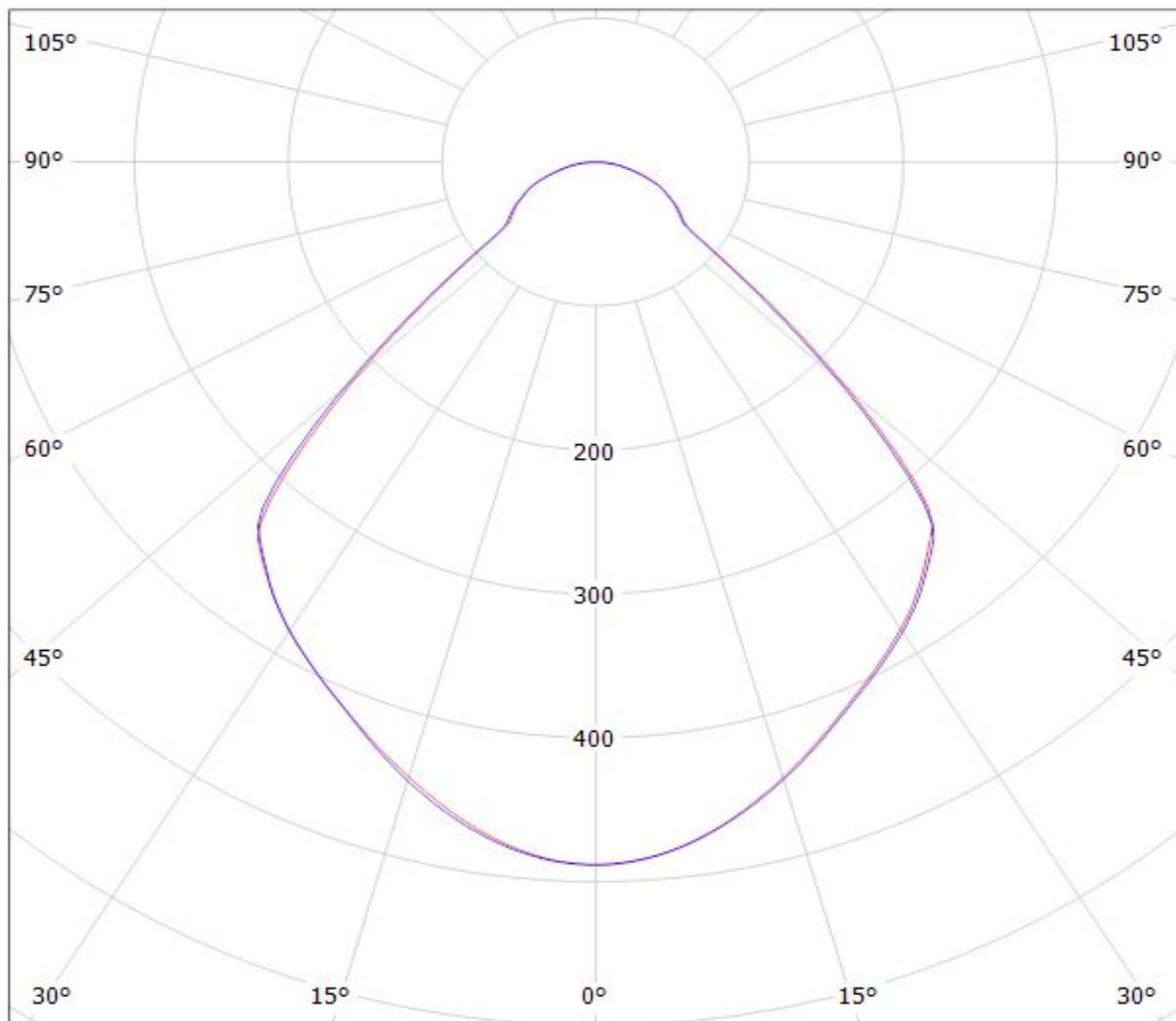

cd/klm

— C0 - C180

— C90 - C270

$\eta = 93\%$

Luminaire: LEDiL Oy F13838_ANGELINA-XW_(K12) Eff.94.0%

Lamps: 1 x Luxeon_K12_937.4lm@250mA_CCT=4000K_P=8.19472_I=249.9mA

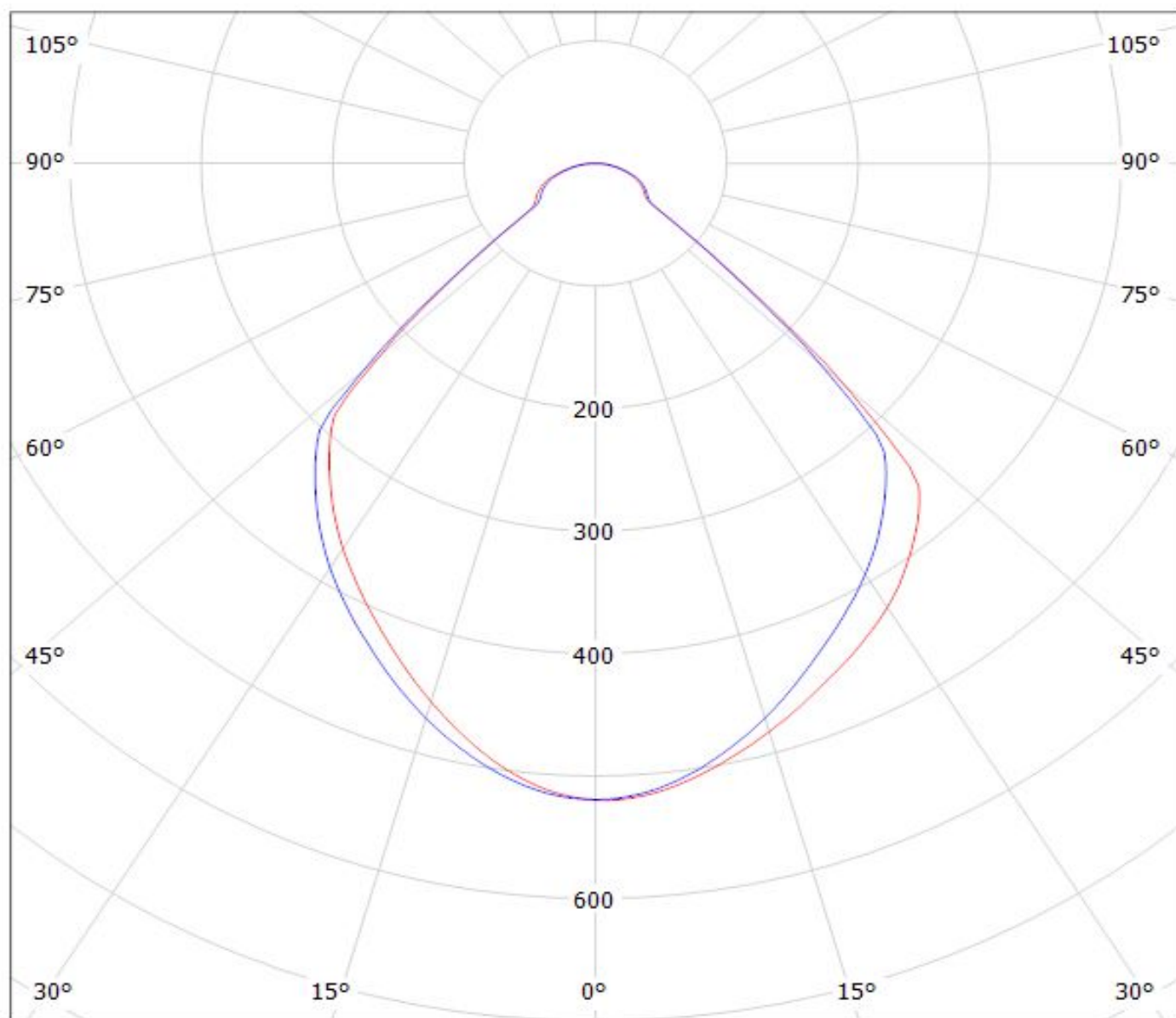

cd/klm

— C0 - C180

— C90 - C270

$\eta = 94\%$

Luminaire: LEDiL Oy F13838_ANGELINA_XW_(MZ) Eff.94.0%

Lamps: 1 x Sharp_Mega_Zenigata_1226.07lm@250mA_P=11.1573W_I=249.8mA

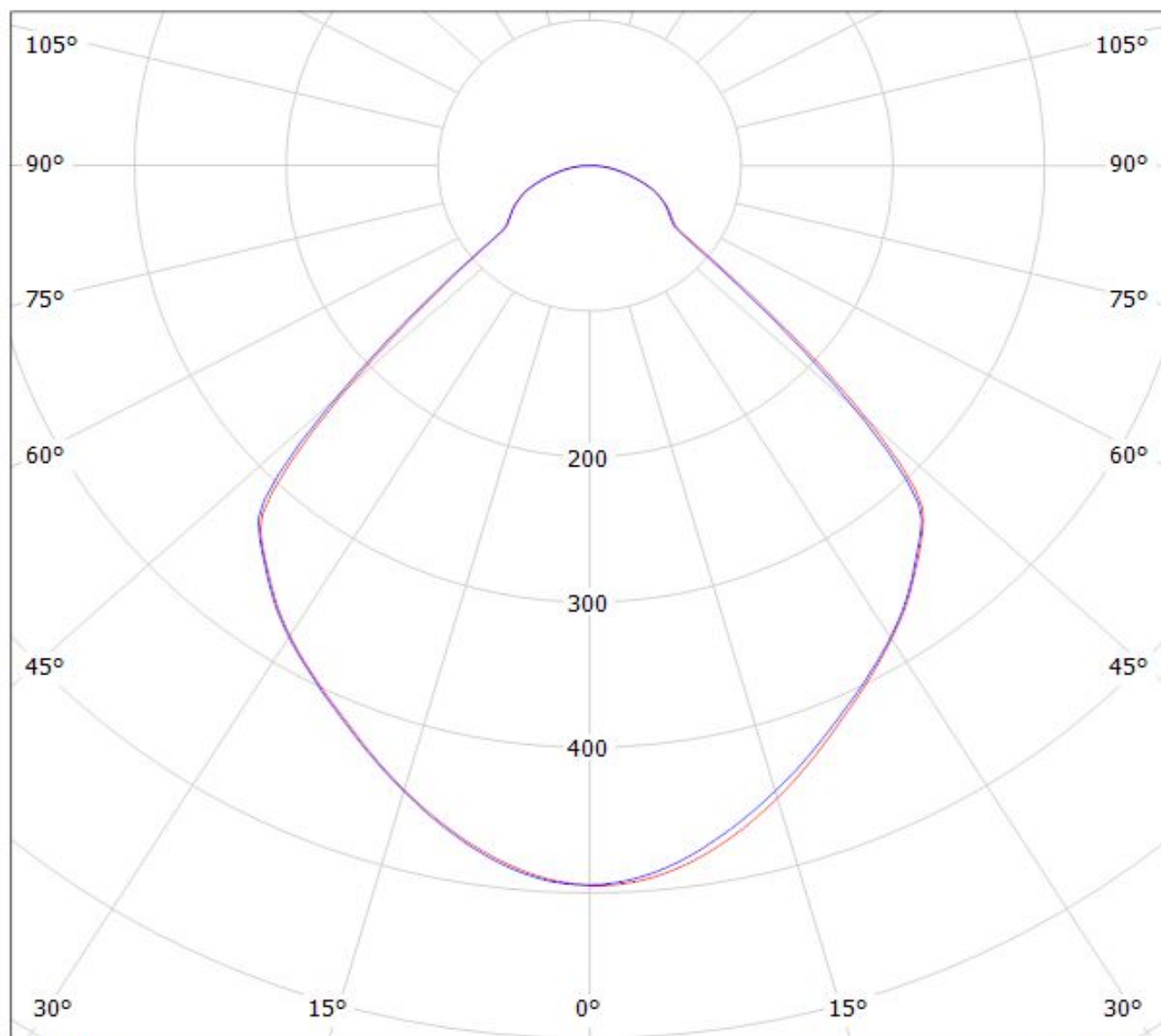

cd/klm

$\eta = 94\%$

— C0 - C180

— C90 - C270

Luminaire: LEDiL Oy F13838_ANGELINA-XW_(WU-M-486) Eff.93.5%
Lamps: 1 x Vossloh_Schwabe-WU-M-486_(WU-M-486-830)
_1474.55lm@250mA_P=10.4456W_I=249.8mA

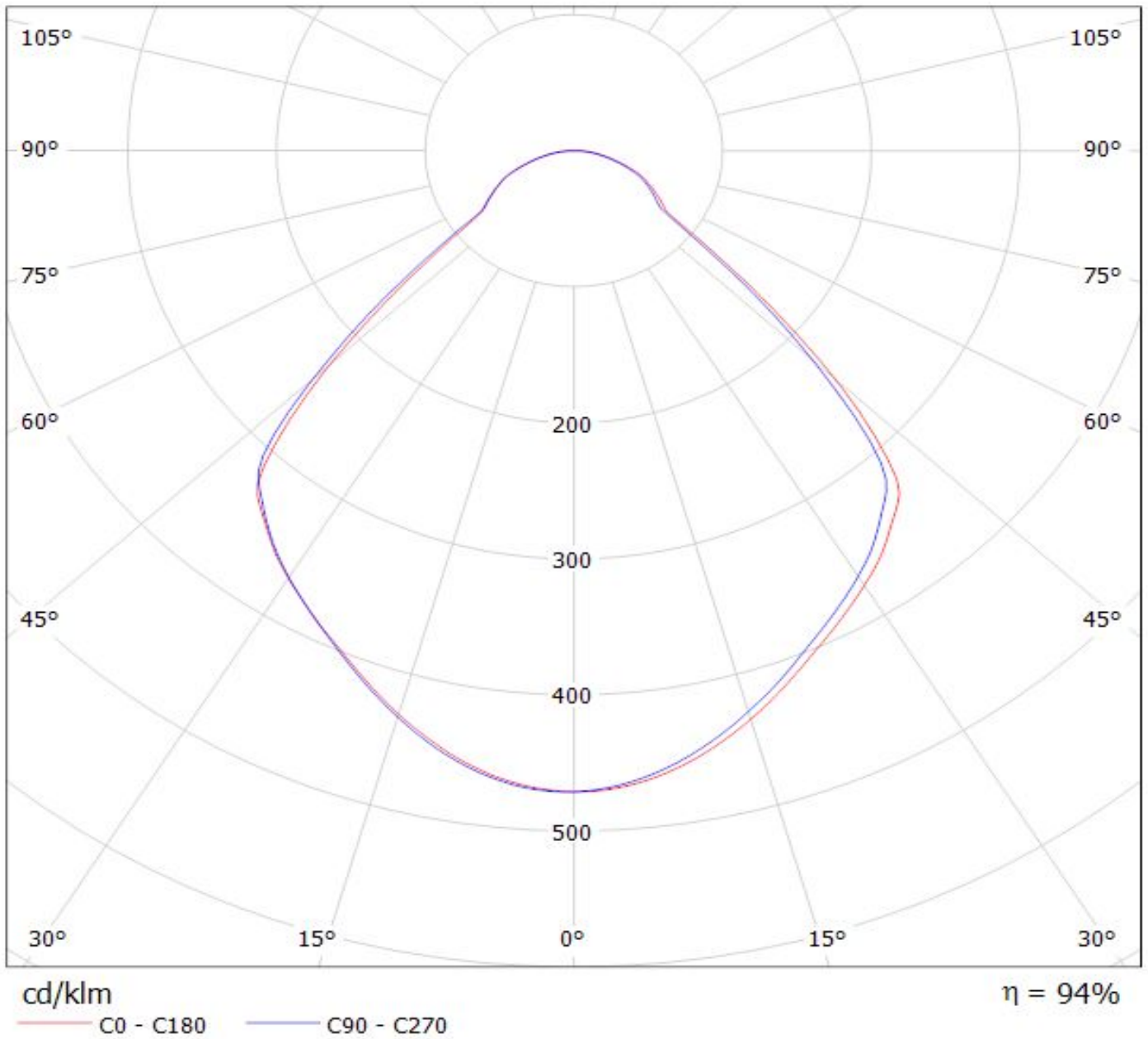

Luminaire: LEDiL Oy F13838_ANGELINA-XW_(SOLERIQ_P13)

Lamps: 1 x SOLERIQ_P13_(GW_MAGMB1.EM)_1038.25lm@250mA_CCT=3000K_P=8.77223W_I=249.8mA

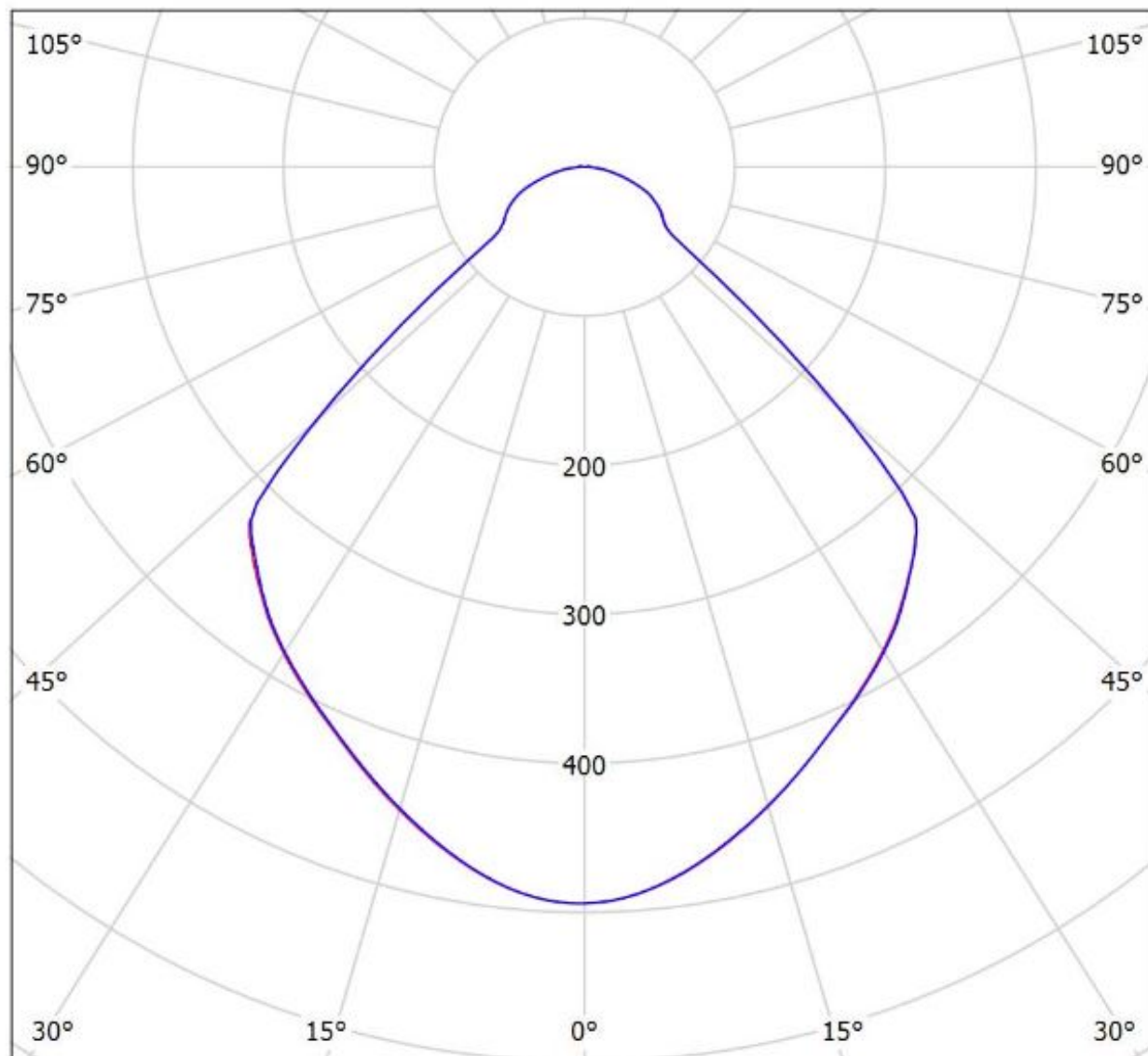

cd/klm

— C0 - C180 — C90 - C270

$\eta = 95\%$

Luminaire: LEDil Oy F13838_ANGELINA-XW_(Soleriq_S13) Efficiency=94%
Lamps: 1 x Osram Soleriq S13 (GW KAGHB1.EM) 855lm @ 250mA CCT=3100K P=7.5W I=250mA

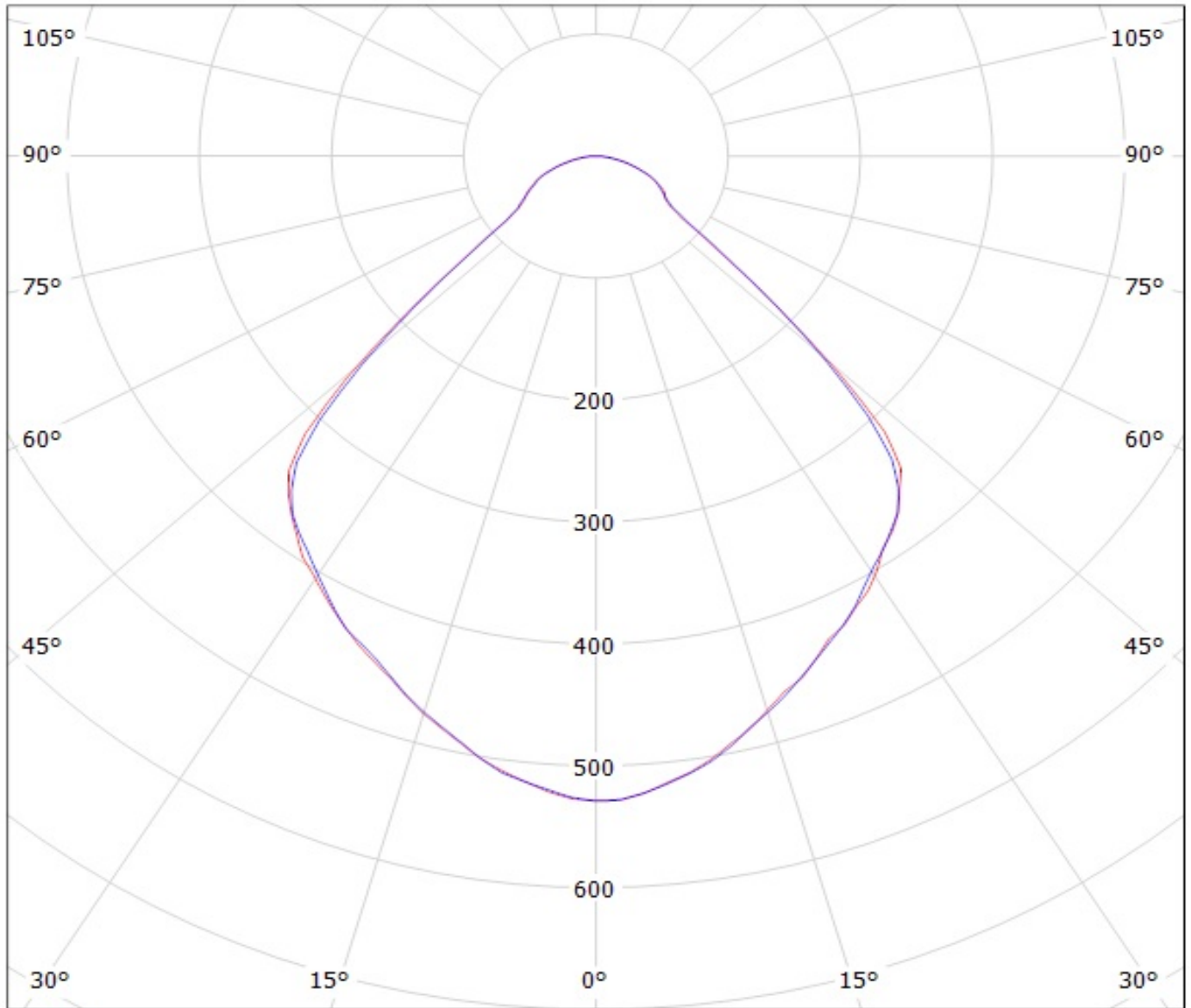

cd/klm

— C0 - C180 — C90 - C270

Luminaire: LEDil Oy F13838_ANGELINA-XW_(NFCxL060B)

Lamps: 1 x Nichia NFCxL060B (SM403G2450R8000) 1250.88lm @ 250mA P=8.4W I=250mA

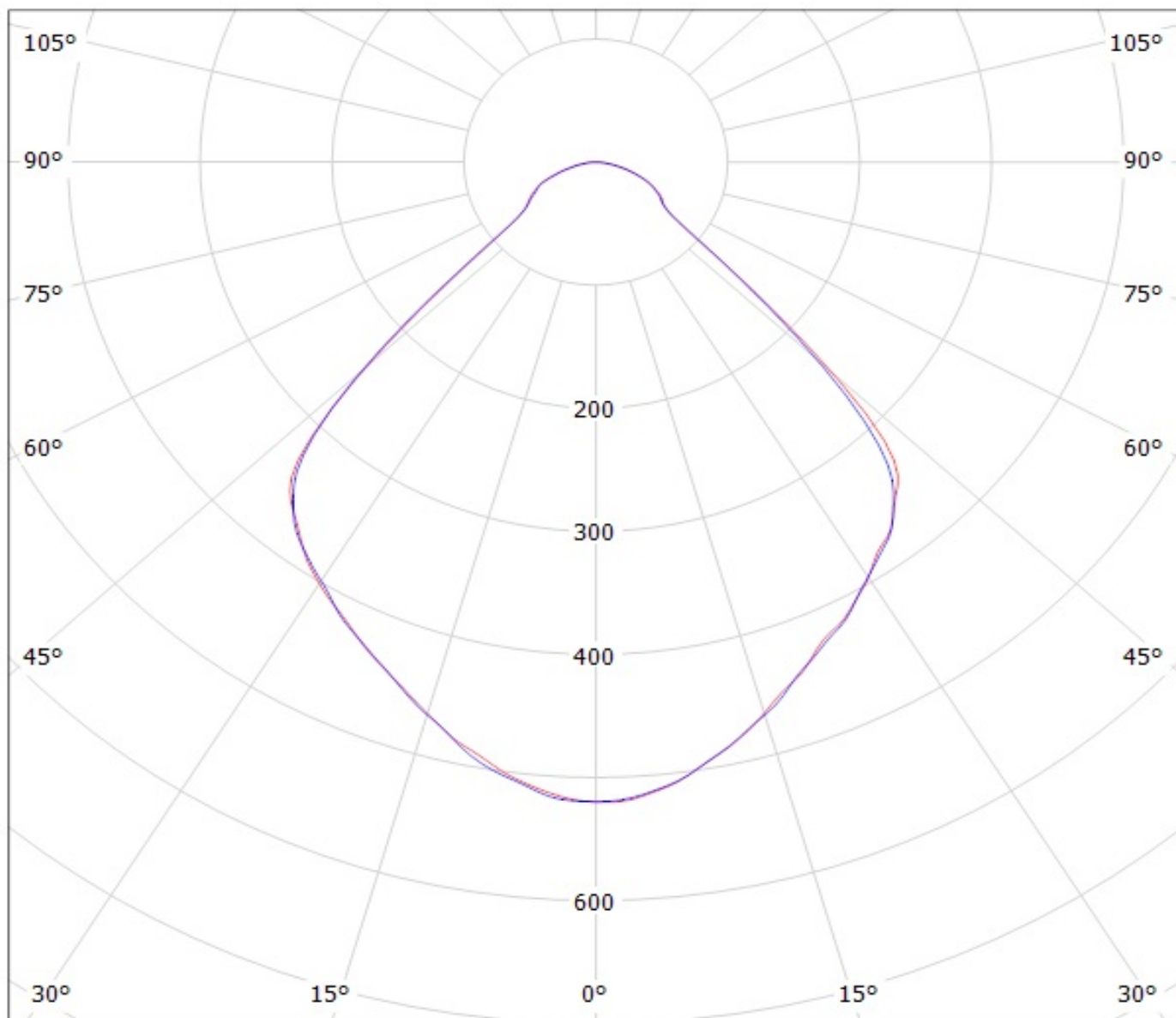

cd/klm

— C0 - C180

— C90 - C270

Luminaire: LEDiL Oy F13838_ANGELINA-XW_(Fortimo LED SLM L13 G4)
Lamps: 1 x Fortimo LED SLM L13 G4_1110.38lm@250mA_P=8.38454W_I=0.2498A

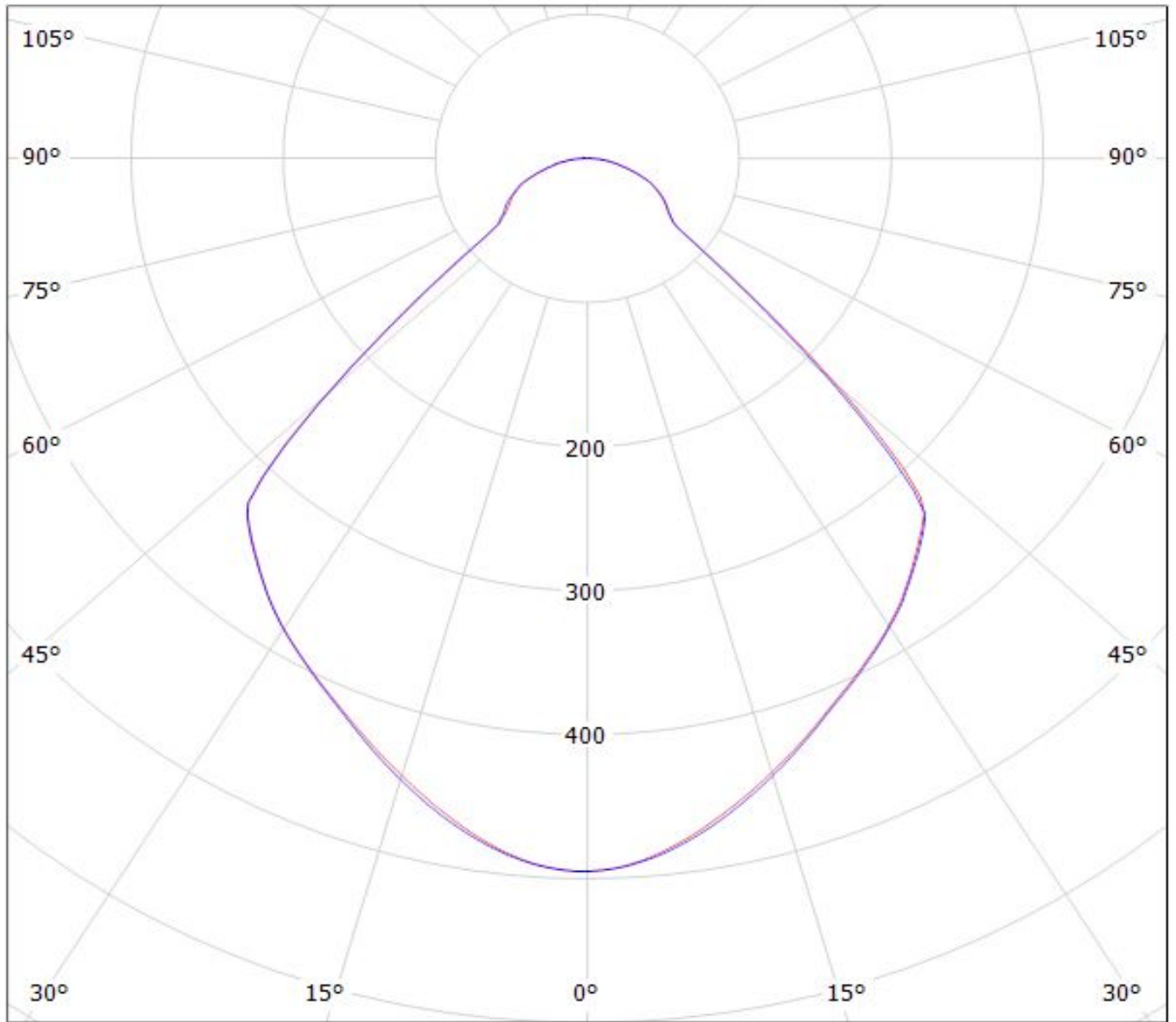

cd/klm

— C0 - C180 — C90 - C270

$\eta = 94\%$

Luminaire: LEDiL Oy F13838_ANGELINA-XW_(Fortimo LED SLM 1100 lm 830 L9 G4)
Lamps: 1 x Fortimo LED SLM 1100 lm 830 L9 G4_1021.27lm@250mA_P=9.2431W_I=0.2498A

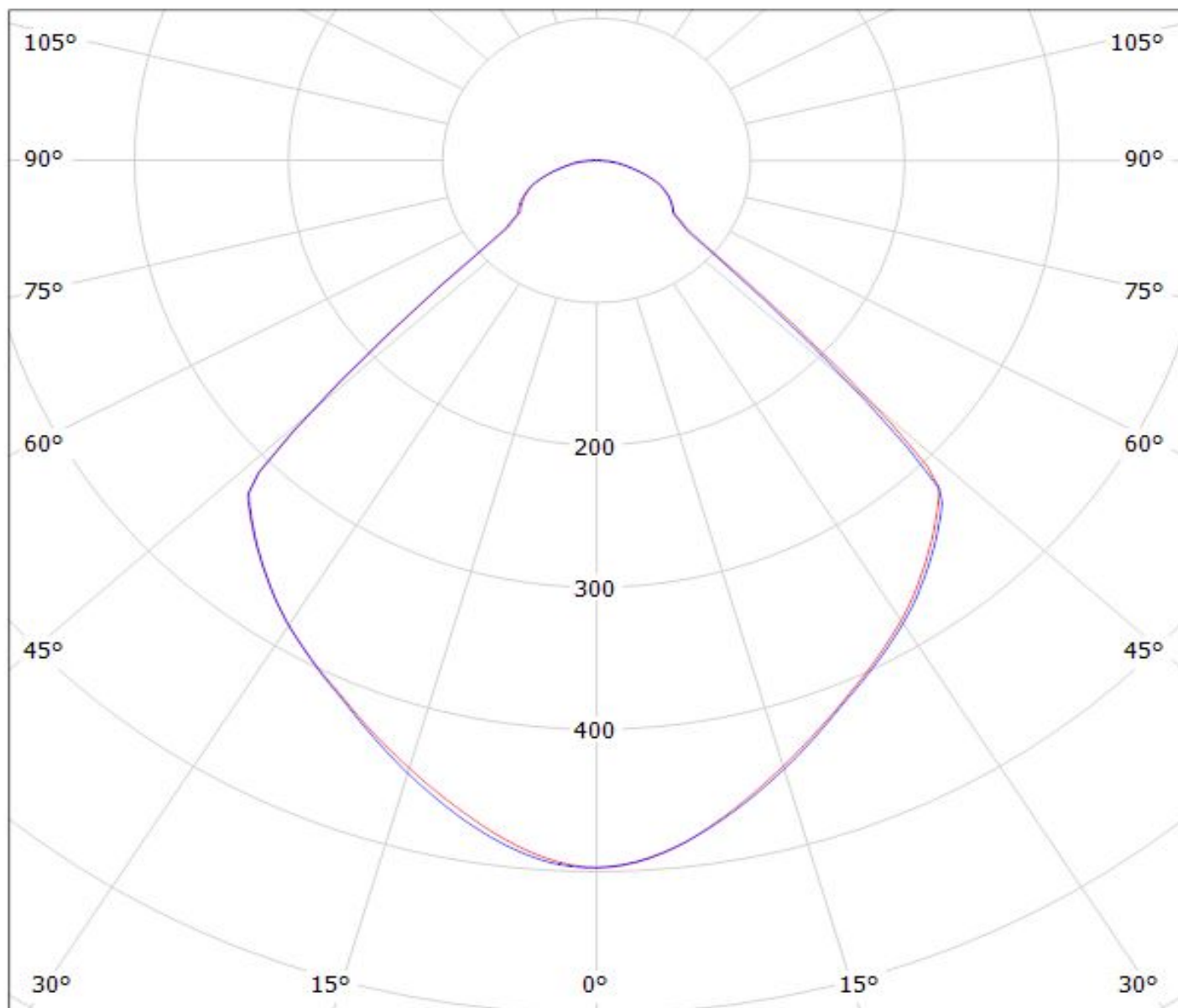

cd/klm

— C0 - C180 — C90 - C270

$\eta = 94\%$

Luminaire: LEDiL Oy F13838_ANGELINA-XW_(WU-M-484)

Lamps: 1 x Vossloh_Schwabe-WU-M-484_(WU-M-484-830)_657.125lm@250mA_P=5.59976W_η=249.9mA

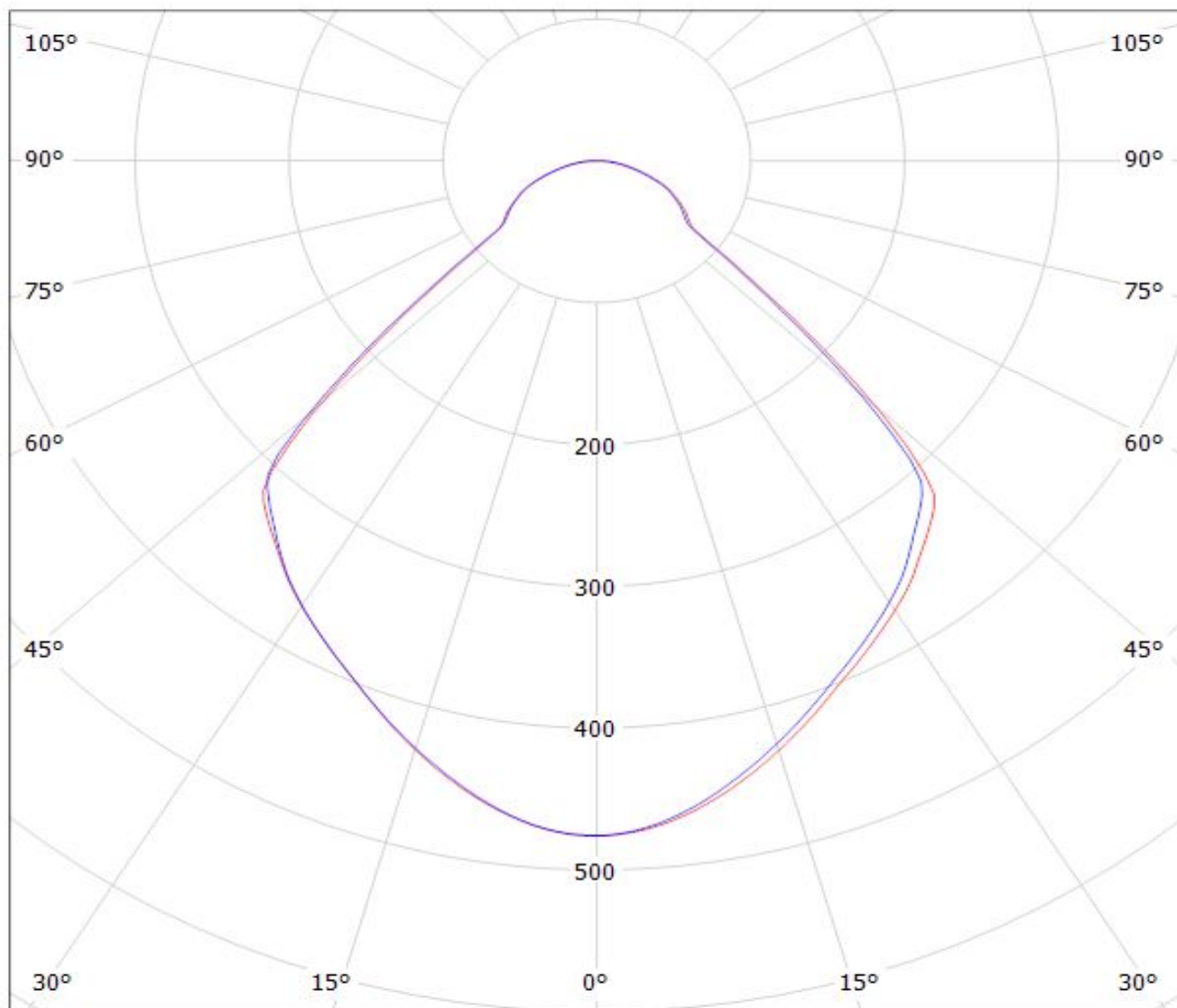

cd/klm

$\eta = 94\%$

— C0 - C180 — C90 - C270

Luminaire: LEDiL Oy F13838_ANGELINA-XW_(WU-M-485)

Lamps: 1 x Vossloh_Schwabe-WU-M-485_(WU-M-485-830)_1209.62lm@250mA_P=8.43849W_I=249.8mA

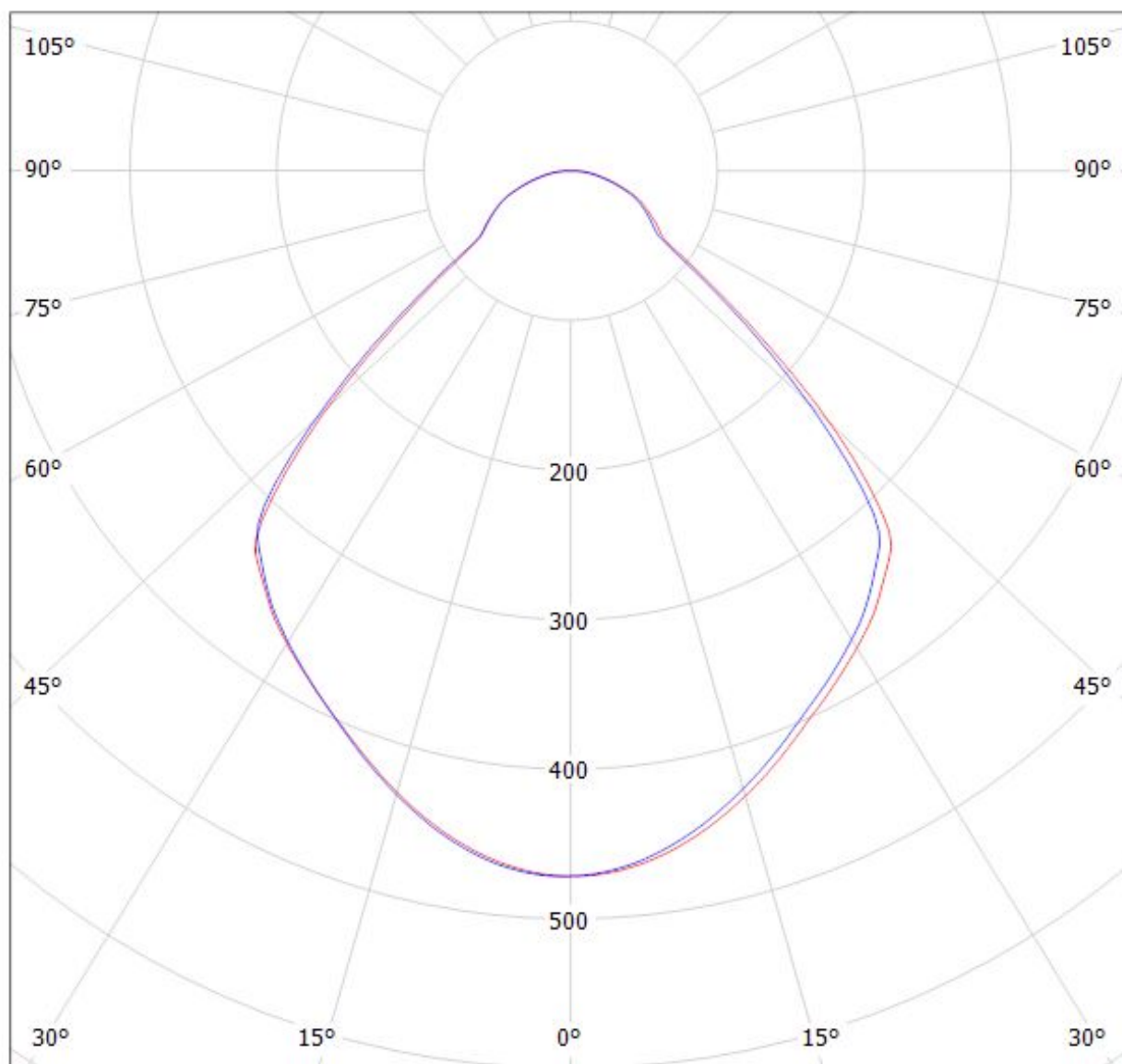

cd/klm

— C0 - C180 — C90 - C270

$\eta = 94\%$

Luminaire: LEDiL Oy F13838_ANGELINA-XW_(CXM-14)

Lamps: 1 x LUMINUS_CXM-14_1114.36lm@250mA_P=8.36106W_I=249.8mA

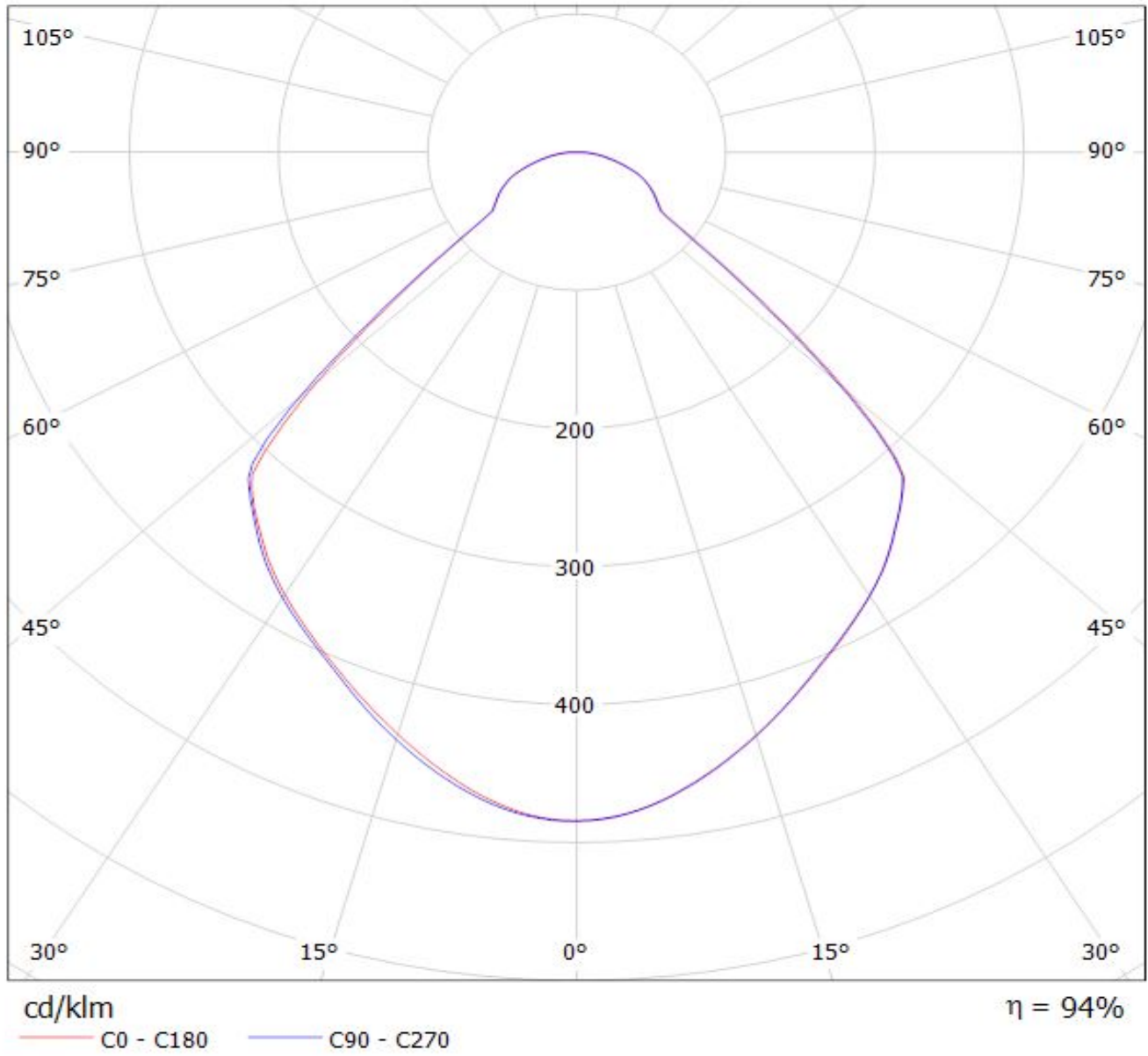

Luminaire: LEDiL Oy F13838_ANGELINA-XW_(WU-M-464) Eff.94.1%

Lamps: 1 x VOSSLOH_WU-M-464-827_1452.09lm@250mA_P=11.7139W_I=249.8mA

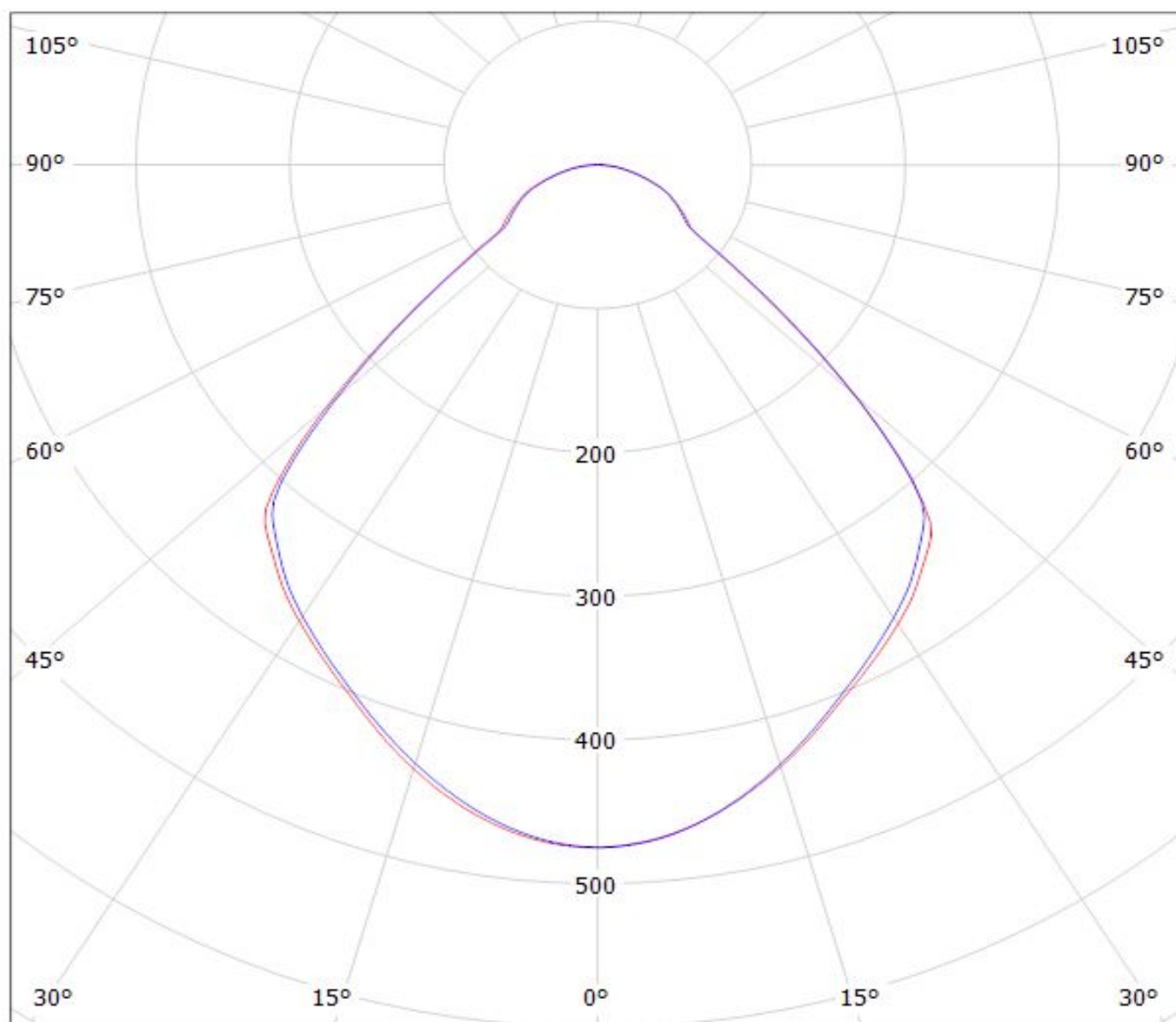

cd/klm

— C0 - C180

— C90 - C270

$\eta = 94\%$

Ledil F13838_ANGELINA-XW_(CLU720) / LDC (Polar)

Luminaire: Ledil F13838_ANGELINA-XW_(CLU720)
Lamps: 1 x CITIZEN_CLU720_(CLU720-1206B8-273M2)
_1340.38lm@250mA_CCT=2700K_P=8.35W_I=0.25A

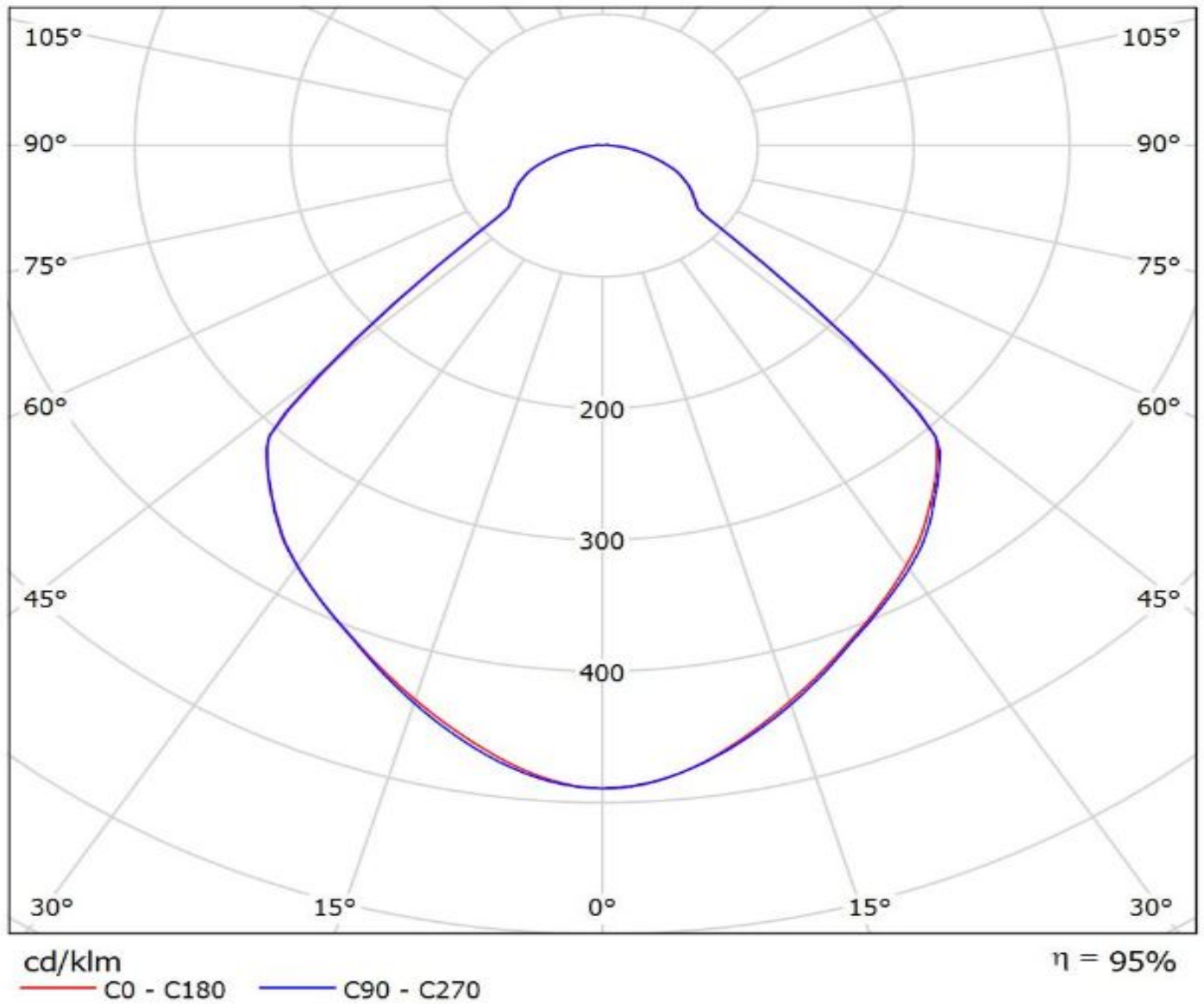

Luminaire: LEDiL Oy F13838_ANGELINA-XW_(NSBxL121A)

Lamps: 1 x Nichia_NSBxL121A_935.409lm@250mA_P=7.57219W_I=249.8mA

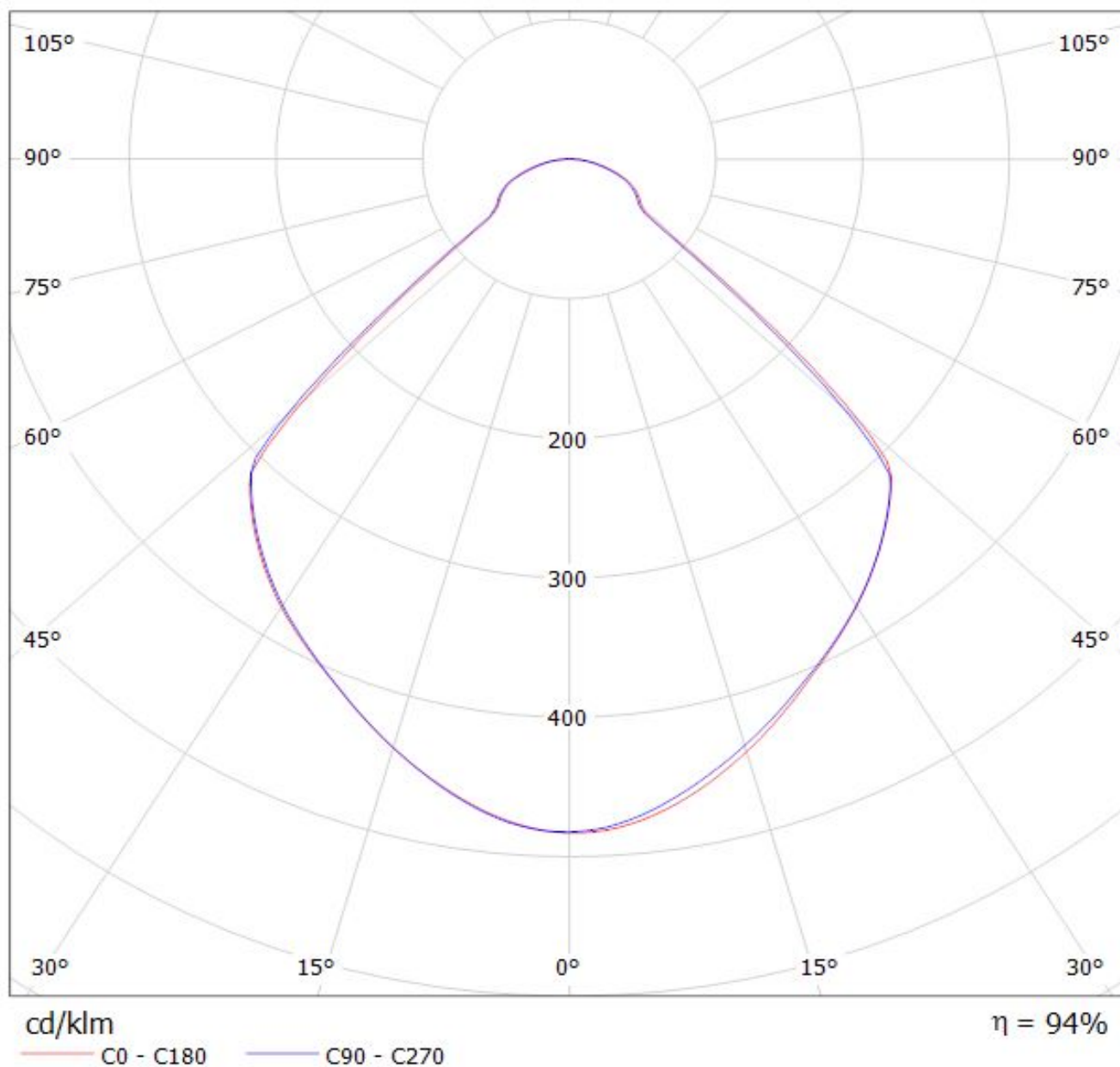

NOTE: The typical divergence will be changed by different color, chip size and chip position tolerance. The typical total divergence is the full angle measured where the luminous intensity is half of the peak value.

GENERAL INFORMATION

- Product series especially designed & optimized for series of LEDs.
- Special care taken to make light distribution as uniform as possible.
- Reflector is made of aluminium coated PC (120 degrees of Celcius / 248 degrees of Fahrenheit) with protective lacquer (short term 100 degrees of Celcius / 212 degrees of Fahrenheit).

Note! Due to use of high power COB's with this product, special attention to proper thermal design is highly recommended. LEDiL has no liability for direct, indirect or consecutive damages arising from the LEDiL products being used outside of the recommended temperature range.