

Datasheet

NF extension lead H05VVF 3G 1.5mm 10m black

RS Article No.: 8771656



General:

NF extension lead H05VVF 3G1.5mm 10m black
Cable:
3G 1.5MM style

Technical data:

Fit for H05VV-F 3G1.0MM cable and 3G1.5MM cable

Marking:

16A/250V

Operating Temperature:

Standard product form -20°C(-4°F) to +80°C(+176°F)

Assembly of accessories:

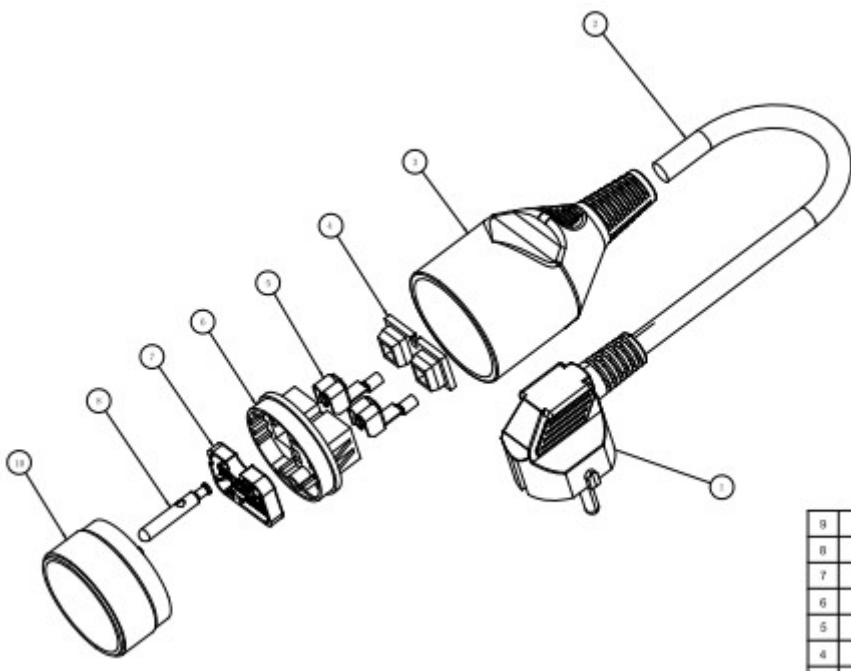

9
8
7
6
5
4