



FXP1500/1800 front-ends have a backplane-mounted AC input.

Applications

- Telecommunications
- Data communications
- Servers
- Distributed power

Features

- RoHS compliant for all six substances
- High density front-ends 15.2 to 18.3 W/in³
- Wide input voltage range 85 to 264 VAC
- 12 V standby voltage, 1A per front-end
- Highly efficient topology reduces operating costs
- I²C interface status and control
- I²C voltage and current limit setting
- Analog output voltage setting
- Overtemperature, output overvoltage, and output overcurrent protection
- ORing circuits for true redundant operation:
V_{o1}: ORing FETs; V_{o2}: ORing Diodes
- Status LEDs: AC OK, DC OK, and Fan Fail/Overtemperature Fail

FXR-3-48G
Power Shelf

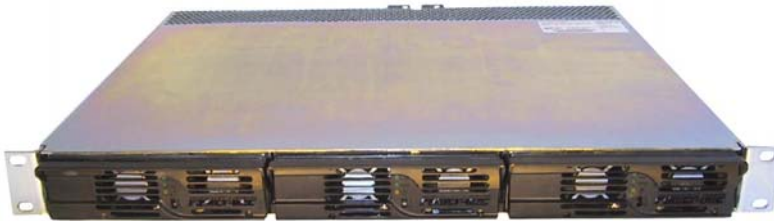

The FXR-3-48G shelf provides up to 5400 watts in a 19" rack.
(See the Rack section for power shelf details.)



Description

The FXP1500/1800 front-ends are power-factor-corrected (PFC) and provide a 48 VDC (1500 or 1800 watt) output, and can be used in hot-swap redundant systems. Their very small dimensions allow configuration of up to three units in a 1U rack. The FXP front-ends have a rear-mounted AC connector. The highly efficient thermal design with internal-fan cooling permits their use over wide temperature ranges and provides very high reliability.

Status information is provided with front panel LEDs, logic signals, and via an I²C management interface. In addition, the I²C bus can enable the power supply, set high fan speed, adjust the output voltage, and set the output current limit. The FXP1500/1800's meet international safety standards and display the CE-Mark for the European Low Voltage Directive (LVD).

FXR-3-48G power-shelf solutions provide rectification, system management, and power distribution, while maintaining high reliability and offering flexibility for future expansion. The power shelves can be configured with up to three hot-swappable 1500 or 1800-watt AC-DC front-ends.

Model Selection

Model	Input voltage VAC auto selected ¹	Output 1		Output 2		Rated power W	Compatible Shelf ²
		V _{o1 nom} VDC	I _{o1 max} ADC	V _{o2 nom} VDC	I _{o2 max} ADC		
FXP1500-48G	105 – 264	48	32.2	12	1	1512	FXR-3-48G
	85 – 105	48	25.4	12	1	1212	
FXP1800-48G	180 – 264	48	39.2	12	1	1812	FXR-3-48G
	105 – 180	48	32.2	12	1	1512	
	85 – 105	48	25.4	12	1	1212	

¹ The available output power is automatically adjusted depending on the input voltage.

² 1U standard racks are available from Power-One. See the Rack (Power Shelf) section of this data sheet for configurations and details.

Absolute Maximum Ratings

Stress in excess of the absolute maximum ratings may cause performance degradation, adversely effect long-term reliability, or cause permanent damage to the converter.

Parameter	Conditions/Description	Min	Max	Unit
Input voltage	Continuous		264	VAC
	Transient, 60 ms max.		300	VAC
Operating ambient temperature	V _{i min} -V _{i max} , I _{o nom} , cooling by internal fan			
	@ 100 % load	0	50	°C
	@ 50 % load	0	70	°C
Storage temperature	Non-Operating	-40	85	°C

Environmental, Mechanical, & Reliability Specifications

Parameter	Conditions/Description	Min	Nom	Max	Unit
Altitude	Operating			10 k	ASL Ft.
	Non-Operating			40 k	ASL Ft.
Relative humidity, non-condensing	Operating	10		90	% RH
	Storage	5		95	% RH
Temperature coefficient	0 °C to 70 °C (after 15 min warm-up)			0.02	%/K
Shock	IEC/EN 60068-2-27, 11 ms			40	g _{pk}
Sinusoidal vibration	IEC/EN 60068-2-6 2-8 Hz 8-200 Hz 200-500 Hz		7.5		mil
			2		g _{pk}
			4		g _{pk}
					g _{rms}
Random vibration	10-2000 Hz		6.15		g _{rms}
MTBF	Calculated per Bellcore (SR-332, Issue 1):				
	GB 25 °C	230			kh
	GB 25 °C (FNP1500-12G) Demonstrated	TBD 250			kh kh

Safety Specifications

Maximum electric strength testing is performed in the factory according to EN 550116, IEC/EN 60950, and UL 60950. Input-to-output electric strength tests should not be repeated in the field. Power-One will not honor any warranty claims resulting from electric strength field tests.

Parameter	Conditions/description	Min	Nom	Max	Unit
Agency approvals	UL60950, (UL) CSA 60950 (cUL), EN 60950(TÜV), CE Mark for LVD				
Insulation safety rating	Input to case Input to output Output to case		Basic Reinforced Functional		
Electric strength test voltage	Input to case Input to output Output to case Output 1 to output 2	2.12 4.2 ¹ 0.5 0.1			kVDC kVDC kVDC kVDC

¹ Subassemblies are pre-tested with 4.2 kVDC in accordance with EN50116 and IEC/EN60950.

EMC Specifications

Parameter	Description	Criterion
Electrostatic discharge	IEC/EN 61000-4-2, level 4	Performance criterion B
Electromagnetic field	IEC/EN 61000-4-3, level 3	Performance criterion A
Electrical fast transients/burst	IEC/EN 61000-4-4, level 3	Performance criterion B
Surge	IEC/EN 61000-4-5, level 3	Performance criterion B
Voltage dips and interruptions	IEC/EN 61000-4-11	Performance criterion B or better
RF conducted immunity	IEC/EN 61000-4-6	10 VAC, AM 80 %, 1 kHz Performance criterion A
Emissions conducted	CISPR 22/EN 55022/EN 61204	Class B
Emissions radiated	CISPR 22/EN 55022/EN 61204	Class A
Harmonics	IEC/EN 61000-3-2	Class B
Voltage fluctuation and flicker	IEC/EN 61000-3-3	Pass
Voltage sag	SEMI F47-0200 (High Line 230V)	Pass

Input Specifications

Specification is valid for input voltage, load, and temperature ranges, unless otherwise stated.

Parameter	Conditions/description	Min	Nom	Max	Unit
Input voltage		85	230	264	VAC
Input frequency		47	50/60	63	Hz
Turn-on input voltage	Ramping up	79	-	85	VAC
Turn-off input voltage	Ramping down	70	-	78	VAC
Inrush current limitation	115/230 VAC acc. ETS 300 132-1 < 100 ms			50	A _{pk}
Hold-up time	After last AC line peak, V _i = 230 VAC, P _{o nom}	20			ms
Power factor	V _{i nom} , I _{o nom}	0.95			W/VA
Efficiency	V _i = 230 VAC, I _{o nom} , T _C = 25 °C	89	90		%
Max input current				20	A _{rms}
Input connector	16A – 20 A / 250 VAC; according to IEC320 C19				

Input Connector Description (FXP1500/1800)

Protection Earth	P1	PE
Phase	P2	L
Neutral	P3	N

Output Specifications, 48Vout Models

Specification is valid for input voltage, load, and temperature ranges, unless otherwise stated.

Parameter		Conditions/Description	Min	Nom	Max	Units
Nominal output voltage Vo1		$I_o = 16.1 \text{ A}$		48		VDC
Nominal output voltage Vo2		$I_o = 0.5 \text{ A}$		12		VDC
Output voltage set point accuracy		$V_i = 230 \text{ VAC}, I_{o1} = 16.1 \text{ A}, T_c = 25 \text{ }^\circ\text{C}$ (47.8 - 48.2 VDC)	-0.5		+0.5	% $V_{o1 \text{ nom}}$
Output voltage trimming (via I ² C or with external resistor)		Adjustable (44.16 to 51.84 VDC)	-8		+8	% $V_{o1 \text{ nom}}$
Nominal current output 1	FXP1500-48G	$I_{o1 \text{ nom}} @ V_i = 105 \text{ VAC} - 264 \text{ VAC}, P_o 1.5 \text{ kW}$		32.2		ADC
		$I_{o1 \text{ nom}} @ V_i = 85 \text{ VAC} - 105 \text{ VAC}, P_o 1.2 \text{ kW}$		25.4		ADC
	FXP1800-48G	$I_{o1 \text{ nom}} @ V_i = 180 \text{ VAC} - 264 \text{ VAC}, P_o 1.8 \text{ kW}$		39.2	39.2	ADC
		$I_{o1 \text{ nom}} @ V_i = 105 \text{ VAC} - 180 \text{ VAC}, P_o 1.5 \text{ kW}$		32.2		ADC
		$I_{o1 \text{ nom}} @ V_i = 85 \text{ VAC} - 105 \text{ VAC}, P_o 1.2 \text{ kW}$		25.4		ADC
Current limit output 1	FXP1500-48G	$I_{o1 \text{ max}} @ V_i = 105 \text{ VAC} - 264 \text{ VAC}$ droop hiccup		36.8		ADC
		$I_{o1 \text{ max}} @ V_i = 85 \text{ VAC} - 105 \text{ VAC}$ droop hiccup		30		ADC
	FXP1800-48G	$I_{o1 \text{ max}} @ V_i = 180 \text{ VAC} - 264 \text{ VAC}$ droop hiccup		43.8		ADC
		$I_{o1 \text{ max}} @ V_i = 105 \text{ VAC} - 180 \text{ VAC}$ droop hiccup		36.8		ADC
		$I_{o1 \text{ max}} @ V_i = 85 \text{ VAC} - 105 \text{ VAC}$ droop hiccup		30		ADC
Nominal current output 2		$I_{o2 \text{ nom}} @ V_i = 85 \text{ VAC} - 264 \text{ VAC}, P_o 12 \text{ W}$		1.0	1.0	ADC
Current limit output 2		$I_{o2 \text{ max}} @ V_i = 85 \text{ VAC} - 264 \text{ VAC}$		1.5		ADC
Static line regulation output 1		$V_{i \text{ min}} - V_{i \text{ max}}, 50 \% I_{o \text{ nom}}$	-0.5		0.5	% $V_{o \text{ nom}}$
Static load regulation output 1 (droop characteristic)	FXP1500-48G	$V_i = 230 \text{ V}, 5-100 \% I_{o \text{ nom}}$ V_o : full load (32.2 ADC) to no load	46.65	83.5 48	49.34	mV/A VDC
	FXP1800-48G	$V_i = 230 \text{ V}, 5-100 \% I_{o \text{ nom}}$ V_o : full load (32.2 ADC) to no load	46.07	83.5 48	49.34	mV/A VDC
Static load regulation output 2 (droop characteristic)		$V_i = 230 \text{ V}, 5-100 \% I_{o \text{ nom}}$ V_o : full load (32.2 ADC) to no load		0.4		VDC
Dynamic load regulation		Load change 50% ↔ 100% $I_{o \text{ nom}}$, $di_o/dt = 1 \text{ A}/\mu\text{s}$ Voltage deviation (droop + over- or undershoot)				% $V_{o \text{ nom}}$
	FXP1500-48G		-5		5	% $V_{o \text{ nom}}$
	FXP1800-48G		-5.7		5.7	% $V_{o \text{ nom}}$
	All models	Max. recovery time to within 1 % of $V_{o1 \text{ nom}}$			400	μs
Current Share		Difference in current between two units for V_{o1} above 10 % load.				
	FXP1500-48G				3.2	ADC
	FXP1800-48G				3.9	ADC
Start-up time		Time required for output within regulation after initial application of AC-input ($V_{i \text{ nom}}, I_{o \text{ nom}}$) after removal of inhibit ($V_{i \text{ nom}}, I_{o \text{ nom}}$)		100	1.5	s ms
Output voltage ripple and noise (Filter 10 nF/10 μF)		$V_{i \text{ nom}}, I_{o \text{ nom}}, 20 \text{ MHz bandwidth}$ V_{o1} V_{o2}			480 120	mV _{pp} mV _{pp}
Remote sense		Total compensation for cable losses			500	mV

Protection

Parameter	Conditions/Description	Min	Nom	Max	Unit
Input fuse	Not user accessible	25A, fast blow			
Inrush current limitation		With NTCs			
Output		No-load -, short circuit - and overload proof			
Overvoltage protection latching ¹	Tracking Absolute	115		122 59.5	% $V_{o\ nom}$ V
Overtemperature protection	Automatic power shutdown at T_C		95		°C

¹ Remove input voltage to reset.

Control

Specification is valid for input voltage, load, and temperature ranges, unless otherwise stated.

Parameter	Conditions/Description
Status Indication	LEDs: DC OK (green), AC OK (green); fan fail and overtemperature (amber)
I ² C digital bus	Monitors alarm functions and sets parameters
PS present pin	Contact closure to logic ground (internal pull-down resistor of 1 kΩ)
PS remote shutdown / Inhibit pin	TTL compatible signal, inhibited when open contact, high or at TTL logic "1". Signal referenced to logic return (LRTN)
Power supply OK (I ² C) ¹	AC OK & DC OK & no overcurrent & no overtemperature & fans working
DC current fail (I ² C) ¹	Overcurrent on I_{o1}
AC fail / Power down warning (I ² C & OC) ²	Provides a warning that the input power has failed at least 5 ms before the output falls out of regulation (<90% $V_{o1\ set}$). Open collector signal with 20 mA pull-down capability, referenced to logic return (LRTN). AC fail will go high or open during power fail condition and will go low when input is within the operating range. A Power Fail warning will turn off the green AC OK LED.
DC fail / Output voltage fault (I ² C & OC) ²	Internal undervoltage and overvoltage supervision of V_{o1} . Open collector signal with 20 mA pull-down capability, referenced to logic return (LRTN). DC fail will go high or open if V_{o1} is < 90% or > 110% of $V_{o1\ set}$, measured in front of the ORing FETs. A green LED on the front panel indicates normal operation. The LED will flash if in parallel operation V_{o1} is OK, but the unit is disabled.
Temperature warning (I ² C & OC) ²	I ² C critical temperature warning: Indicates that the operating temperature has reached $[T_{shut-down} - 10K]$ I ² C & OC overtemperature warning: Indicates if the unit is in overtemperature shutdown. Open collector signal with 20 mA pull-down capability, referenced to logic return (LRTN). The OC-output will go low 100 ms before an overtemperature condition shuts down the unit. An amber LED on the front panel indicates overtemperature or fan fail.
DC voltage monitoring (I ² C) ¹	Monitors the voltage V_{o1} at the output connector. Accuracy ± 0.45 V over setting range, temperature and load.
DC current monitoring (I ² C) ¹	Monitors the output current I_{o1} : Accuracy $\pm 0.4A$ over the load range.
DC voltage trimming (I ² C or external resistor) ¹	Output voltage trimming V_{o1} : $\pm 8\%$ of $V_{o\ set}$ Setting accuracy over I ² C: $\pm 50mV$ at $V_{o\ nom}$, ± 150 mV over setting range
Fan speed control (I ² C) ¹	Two fan speed levels automatically set depending on the internal temperature. The fan speed can be set to full speed or automatic control.
Fan OK (I ² C & OC) ²	Indicates if the fans are operating or have failed.
Synch. startup pin	Overcurrent signal which can be used for synchronous startup of units in parallel or to recover from an overload condition. (See application note).

¹ Detailed I²C information is available from the model's I²C Manual found on the Power-One web site.

² Provided over the I²C interface and as an open collector signal on the output connector (OC).

Output Connector Pinning and Signal Specification (48V Models)

Output Connector Description	Pin Location	Type	Low level High level	V max I max
Overtemperature / Fan Fail	U1	OC-output, protected by 16 V Zener diode and a 10 Ω resistor in series, referenced to logic GND	<0.4 V @ 20 mA Pull up	15 V 20 mA
AC Fail / Power down warning	U2	OC-output, protected by 16 V Zener diode and a 10 Ω resistor in series, referenced to logic GND	<0.4 V @ 20 mA Pull up	15 V 20 mA
Power Supply Present	U3	Resistor (1 kΩ) connected to logic GND	Open Pull up	10 V 10 mA
DC Fail / Output voltage fault	U4	OC-output, protected by 16 V Zener diode and a 10 Ω resistor in series, referenced to logic GND	<0.4 V @ 20 mA Pull up	15 V 20 mA
Internal ground	U5	Internal ground (V_{o1-} line before the output filter). Do not connect the internal grounds in systems with several units.		
ADDR0, I ² C address bus	T1	DIP switch or wire to internal ground, Internally pull up to 5V (10 kΩ).	Switch closed Switch open	5V
ADDR1, I ² C address bus	T2	DIP switch or wire to internal ground, Internally pull up to 5V (10 kΩ).	Switch closed Switch open	5V
ADDR2, I ² C address bus	T3	DIP switch or wire to internal ground, Internally pull up to 5V (10 kΩ).	Switch closed Switch open	5V
ADDR3, I ² C address bus	T4	DIP switch or wire to internal ground, Internally pull up to 5V (10 kΩ).	Switch closed Switch open	5V
ADDR4, I ² C address bus	T5	DIP switch or wire to internal ground, Internally pull up to 5V (10 kΩ).	Switch closed Switch open	5V
DATA, I ² C data line	S1	I ² C compatible signal referenced to logic GND	5 V or 3.3 V logic	
CLOCK, I ² C clock line	S2	I ² C compatible signal referenced to logic GND	5 V or 3.3 V logic	
Auxiliary power +12 V	S3	V_{o2+} output, insulated from main output		
Auxiliary power ground	S4	V_{o2-} output, insulated from main output		
Logic ground	S5	Internally connected over 10 Ω to Auxiliary GND. Wire separately from Auxiliary - and main output GND to minimize noise on signals and I ² C. Leave open if not used.		
Output inhibit	R1	PS active when pulled low (DC-DC stage off when left open) Referenced to logic GND	<0.8 V >2.0 V	10 V 3.5 mA
V sense +	R2	Open or connected to V_{o1+} at the load (Internally connected to V_{o1+} over 100 Ω)		dV < 3 V _{pp} 30 mA
V sense -	R3	Open or connected to V_{o1-} at the load (Internally connected to V_{o1-} over 100 Ω)		dV < 3 V _{pp} 30 mA
Output margin	R4	Open or connected to internal ground (+8 % V_{o1}) or V_{sense+} (-8 % V_{o1}) Do not connect the margin pins in systems with several units.		60V
Synch. Startup	R5	Open or connected to synch startup circuit, referenced to V_{o1-} at the output connector		12V 2mA
V_{o1-}	P1, P3, P5	Main output – pins		
V_{o1+}	P2, P4, P6	Main output + pins		

Mechanical Data (FXP1500/1800 48V Models)

Mechanical Data (H, W, D)	5.6" (141.2mm) x 1.6" (40.5mm) x 12" (304.8mm)
---------------------------	--

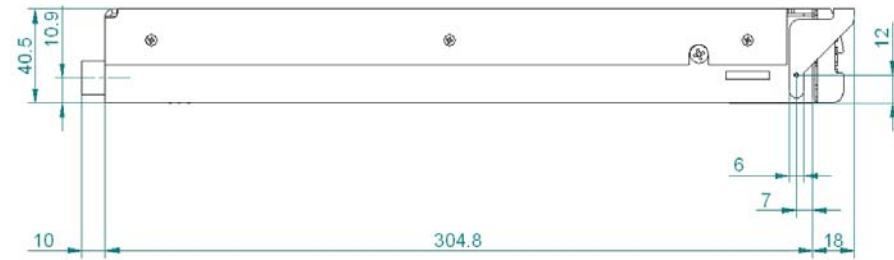

Output Connector FCI part no. 51732-020LF

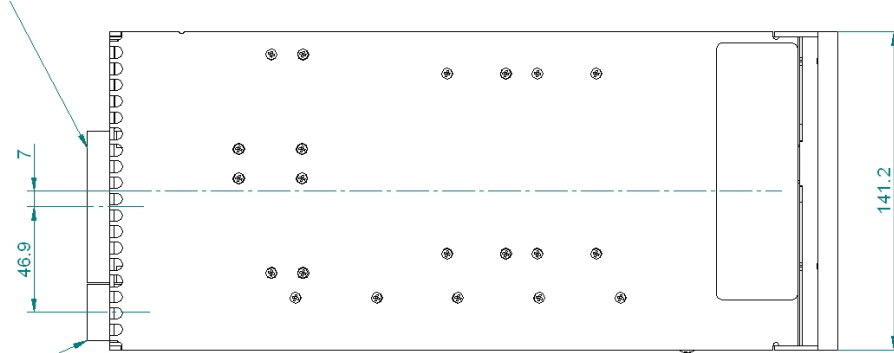

Input Connector FCI part no. 51939-126LF

FXP1500/1800 48V Model Output Connector Descriptions

Rear View

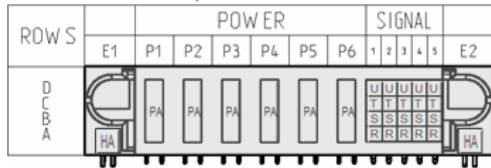
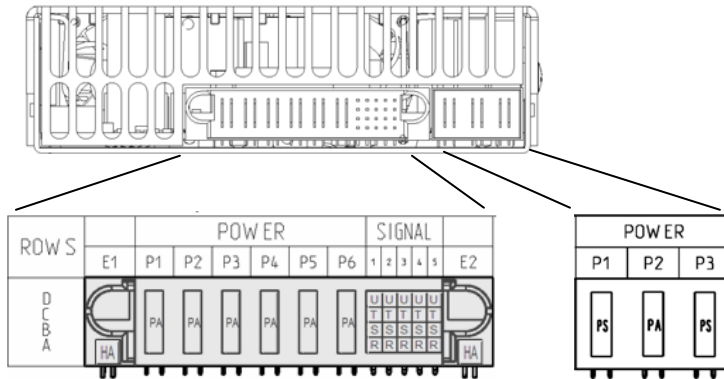



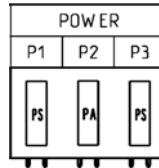

Female Connector: FCI (51732-020 LF)



Input Connector: FCI (51939-126 LF)

Mates With:

- 90° output connector type:  Part No. FCI (manufacturer): 51762-10602000AALF; Power-One Part No.: ZES258-G
- 180° output connector type:  Part No. FCI (manufacturer): 51742-10602000AA LF
- 90° input connector type:  Part No. FCI (manufacturer): 51915-056 LF
- 180° input connector type:  Part No. FCI (manufacturer): 51940-099 LF

Locate information on availability of FCI connectors at <http://www.stkcheck.com/evs/fcielectronics/fcisearch.asp>
Connector drawings available at: <http://portal.fciconnect.com/portal/page/portal/FcicntPublic/DocSrchCustDraw>

Paralleling Front-Ends:

For parallel use in minimal configuration systems, only the inhibit pins must be shorted to logic GND. All other pins can be left open. The power supplies will share the output current automatically (droop current share).

For parallel applications without I²C bus, but the use of all other features, it is recommended to connect all logic GND's on a backplane together, to connect all V_{o2} -, all V_{o2} + and to leave the internal GND's open.

The sense wires can be left open or connected to a common load point, the synch-start pin can be left open or connected to a synch-start circuit, the inhibit pins can be connected together or used individually. All I²C signals (T1-T5, S1, and S2) can be left open.

Use of a small foil capacitor > 3µF directly at the power outputs of each unit is recommended in order to prevent voltage drops at the hot plug. For additional information on paralleling see the following Rack (Power Shelf) section.

Racks

(FXR-3-48G Power Shelves)



Each rack (power shelf) is 1U high with backplane and designed for up to three front-end models in parallel or in n+1 operation. Each power shelf has:

- Massive copper bus bars for low-loss current distribution.
- Output terminals with two M4-screws on each power tab.
- Two fast-on contacts for system earthing.
- Address coding over five pole DIP switch on each unit, 37-pin D-Sub connector with I²C-lines, monitoring signals and support functions.
- Provides a start-up synchronization circuit and EMV filters.



FXR-3-48G Power Shelf Front View

Overall Mechanical Dimensions (FXR-3-48G Power Shelves)

FXR-3 Mechanical Data (W, H, D)	17.7" (449.6 mm) x 1.7" (43.1 mm) x 14" (355.6 mm)
---------------------------------	--

Output Connector Descriptions (FXR-3-48G)

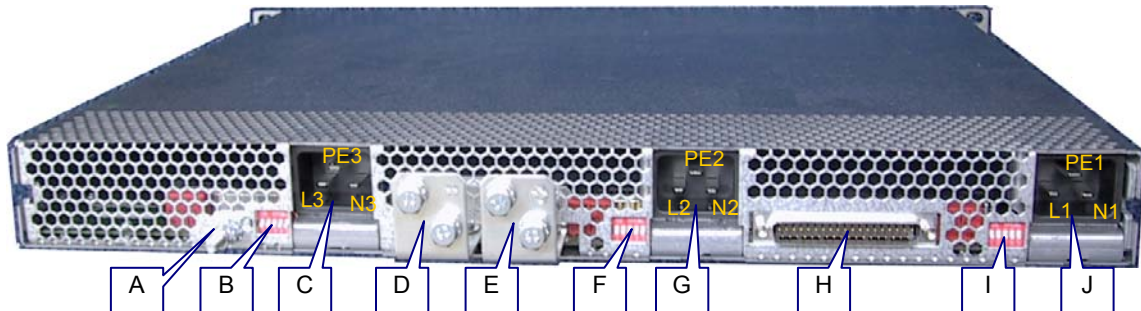

Location	Description
A	Earth connection
B	5-bit DIP switch for I ² C addressing of PSU #3
C	Mains connector of PSU #3
D	Output 1 Minus
E	Output 1 Plus
F	5-bit DIP switch for I ² C addressing of PSU #2
G	Mains connector of PSU #2
H	37-pin SUB-D connector, control, sense, check and Auxiliary power (Output 2)
I	5-bit DIP switch for I ² C addressing of PSU #1
J	Mains connector of PSU #1

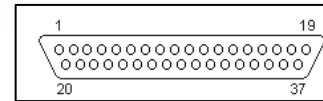

SUB-D Output Connector Pinout and Signal Specification

Output Connector Description	Pin Location	Type	Low level High level	V max I max
Overtemperature / Fan Fail PSU1	1	OC-output, protected by 16 V Zener diode and a 10 Ω resistor in series, referenced to logic GND	<0.4 V @ 20 mA Pull up	15 V 20 mA
Power Supply Present PSU 1	2	Resistor (1 kΩ) connected to logic GND	Open Pull up	10 V 10 mA
Power Supply Present PSU 2	3	Resistor (1 kΩ) connected to logic GND	Open Pull up	10 V 10 mA
Open	4			
Overtemperature / Fan Fail PSU 3	5	OC-output, protected by 16 V Zener diode and a 10 Ω resistor in series, referenced to logic GND	<0.4 V @ 20 mA Pull up	15 V 20 mA
AC Fail / Power down warning PSU 3	6	OC-output, protected by 16 V Zener diode and a 10 Ω resistor in series, referenced to logic GND	<0.4 V @ 20 mA Pull up	15 V 20 mA
Power Supply Present PSU 3	7	Resistor (1 kΩ) connected to logic GND	Open Pull up	10 V 10 mA
DC Fail / Output voltage fault PSU 3	8	OC-output, protected by 16 V Zener diode and a 10 Ω resistor in series, referenced to logic GND	<0.4 V @ 20 mA Pull up	15 V 20 mA
Overtemperature / Fan Fail PSU 2	9	OC-output, protected by 16 V Zener diode and a 10 Ω resistor in series, referenced to logic GND	<0.4 V @ 20 mA Pull up	15 V 20 mA
Synch._Start_A	10	Sync_start_A , Active high The signals of several racks can be connected together in such a way that all supplies will be inhibited until the last supply has recovered from its overcurrent condition, referenced to logic GND	<7V off < 9V	15V 10mA
Open	11			
Output inhibit PSU 1-3	12	Active low (DC-DC stage off when pin is open or on high potential) Referenced to logic GND	<0.8 V >2.0 V	10 V 3.5 mA
V sense +	13	Open or connected to V _{o1+} at the load Internally (PSU) connected to V _{o1+} over 100 Ω		dU < 3 V _{pp} 30 mA
V sense -	14	Open or connected to V _{o1-} at the load Internally (PSU) connected to V _{o1-} over 100 Ω		dU < 3 V _{pp} 30 mA
Open	15			
NC	16			
NC	17			
NC	18			
NC	19			
AC Fail/ Power-down warning PSU 1	20	OC-output, protected by 16 V Zener diode and a 10 Ω resistor in series, referenced to logic GND	<0.4 V @ 20 mA Pull up	15 V 20 mA
DC Fail/ Output voltage fault PSU 1	21	OC-output, protected by 16 V Zener diode and a 10 Ω resistor in series, referenced to logic GND	<0.4 V @ 20 mA Pull up	15 V 20 mA
AC Fail/ Power-down warning PSU 2	22	OC-output, protected by 16 V Zener diode and a 10 Ω resistor in series, referenced to logic GND	<0.4 V @ 20 mA Pull up	15 V 20 mA
DC Fail/ Output voltage fault PSU 2	23	OC-output, protected by 16 V Zener diode and a 10 Ω resistor in series, referenced to logic GND	<0.4 V @ 20 mA Pull up	15 V 20 mA
DATA, I ² C data line	24	I ² C compatible signal referenced to logic GND	5 V or 3.3 V logic	

SUB-D Output Connector Pinout and Signal Specification (Continued)

Output Connector Description	Pin Location	Type	Low level High level	V max I max
CLOCK, I ² C clock line	25	I ² C compatible signal referenced to logic GND	5 V or 3.3 V logic	
Auxiliary power +12 V (Output 2)	26	V ₀₂₊ Aux output, insulated from main output		
Auxiliary power ground (Output 2)	27	V ₀₂₋ Aux output, insulated from main output		
Logic Gnd	28	Internally connected over 10 Ω to V ₀₂₋ , Auxillary GND. Wire separately from auxiliary and main output GND to minimize noise and avoid voltage drops on signal- and I ² C return. Leave open if not used.		
Output margin PSU 1	29	Open or connected to V _{sense-} V _{sense-} (+8 % V ₀₁) or V _{sense+} (-8 % V ₀₁)		60V
Output margin PSU 2	30	Open or connected to V _{sense-} V _{sense-} (+8 % V ₀₁) or V _{sense+} (-8 % V ₀₁)		60V
Output margin PSU 3	31	Open or connected to V _{sense-} V _{sense-} (+8 % V ₀₁) or V _{sense+} (-8 % V ₀₁)		60V
NC	32			
NC	33			
NC	34			
NC	35			
NC	36			
NC	37			

Synchronized start-up circuit for paralleling operation

The FXP1500-48G and FXP1800-48G power supplies exhibit an overcurrent hiccup behaviour. This means if either of these supplies reaches an overcurrent limit, the output voltage will immediately turn OFF and after a delay turn ON again. In parallel use, all power supplies have to start synchronized because of the internal hiccup behaviour. Otherwise, the supply which has reached overcurrent first will go to hiccup; this will overload the other supplies, which then will also go to hiccup. When the first supply has recovered from hiccup (hiccup dead time), the others remain in hiccup. This will immediately drive the first one into hiccup once again. This means that without a start-up circuit, a system with several power supplies can never recover from an overload condition or start-up into full load.

The following additional circuit, required to reach synchronized startup, is already implemented inside the FXR-3-48G shelf.

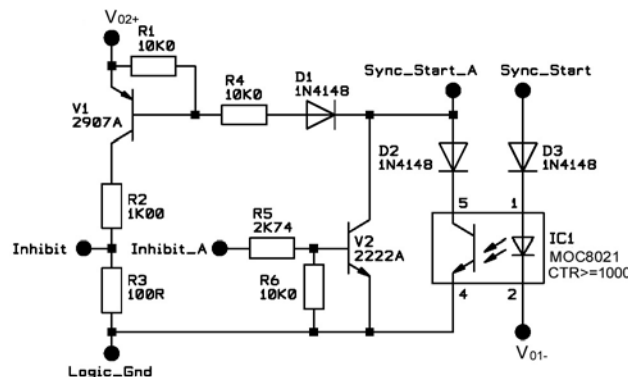

Synch Start-up Connection Between Shelves

The following connection between the shelves is required to achieve a parallel operation. The synch-start circuits inside the shelves inhibit all power supplies until the last one has recovered from its overcurrent condition and then synchronize the restart of the outputs.

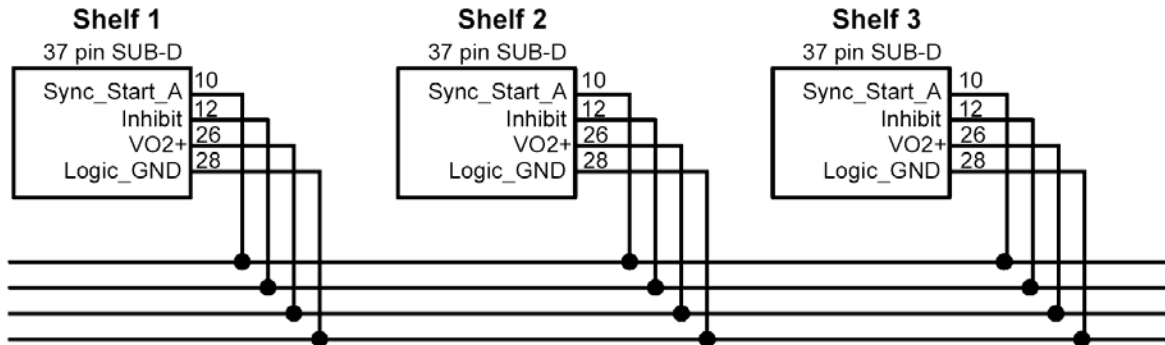

Synch Start-up Circuit Description

Description	Pin Location, Definition	Type	Low level High level	V max I max
Auxiliary power +12 V (Output 2)	26	V _{o2+} , Aux output, insulated from main output		
Logic ground	28	Logic_GND ,Internally connected over 10 Ω to V _{o2-} , (Auxiliary power ground (Output 2))		
Output inhibit_A PSU 1-3	12	Inhibit_A ,Active low (DC-DC stage off) Referenced to Logic_GND	<0.8 V >2.0 V	10 V 3.5 mA
Synch. Startup 1 PSU 1-3	R5 (at PSU)	The synch_start pin is connected to the overcurrent signal of the PSU1-3. In the case of an overcurrent shutdown, this signal goes high. Referenced to V _{o1-}	<7V off > 9V	15V 10mA
Synch. Startup_A Rack FXR-3-48G 1-N Pin on the D-Sub connector on the backplane	10	Sync_start_A , Active high The signals of several racks can be connected together in such a way that all supplies will be inhibited until the last supply has recovered from its overcurrent condition. Referenced to Logic_GND		

NOTE: The Sync-Start pins can be wired together only if the power supplies are connected with a minimal voltage drop on power ground as achieved on a backplane with massive copper bus bars. If there is a less ideal connection, it is recommended to use an opto-coupler for each unit (IC1, D3, D2).

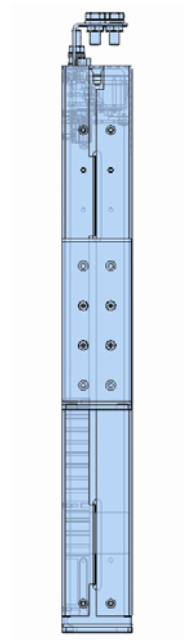
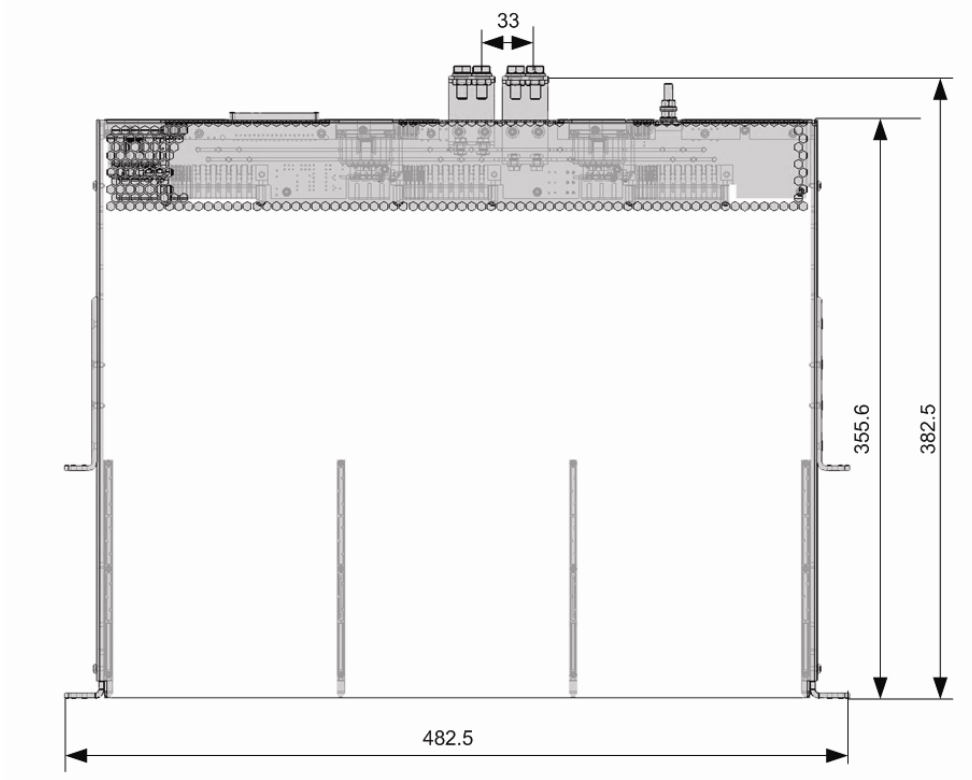

Mechanical Data (FXR-3-48G Power Shelf)

Accessories:

Center Angular Brackets are set in the middle for shelf mounting:

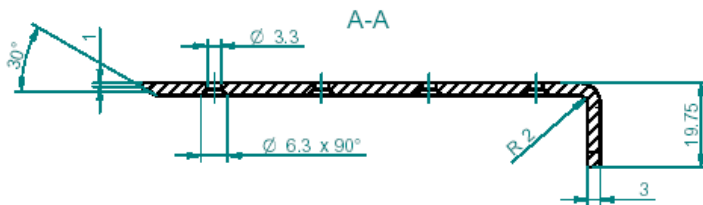
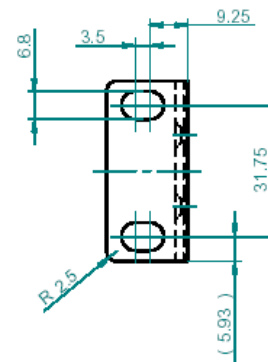
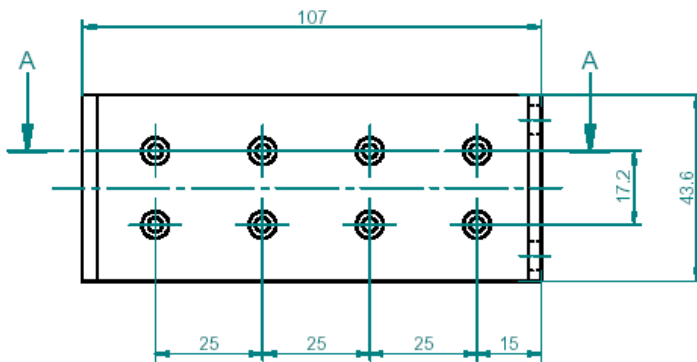

Center Angular Bracket sets can be ordered: Power-One part no.: HZZ01222
Note: Each Center Angular Bracket set contains 2 brackets and 8 screws.

Fulcrum:

The handle has been designed to allow easy plug-in and -out in a rack system. The handle (lever) fits into a counter piece (fulcrum) which is fixed to the bottom of the rack. During the plug, the fulcrum holds the unit down and guides it towards the output connector. The Power-One part number of the fulcrum and its associated mounting accessories is: HZZ01223.

Individual fulcrum sets can be also ordered: Power-One part no.: HZZ01223.

Note: Each HZZ01223 set contain 2 fulcrums, 2 supports, and mounting accessories.

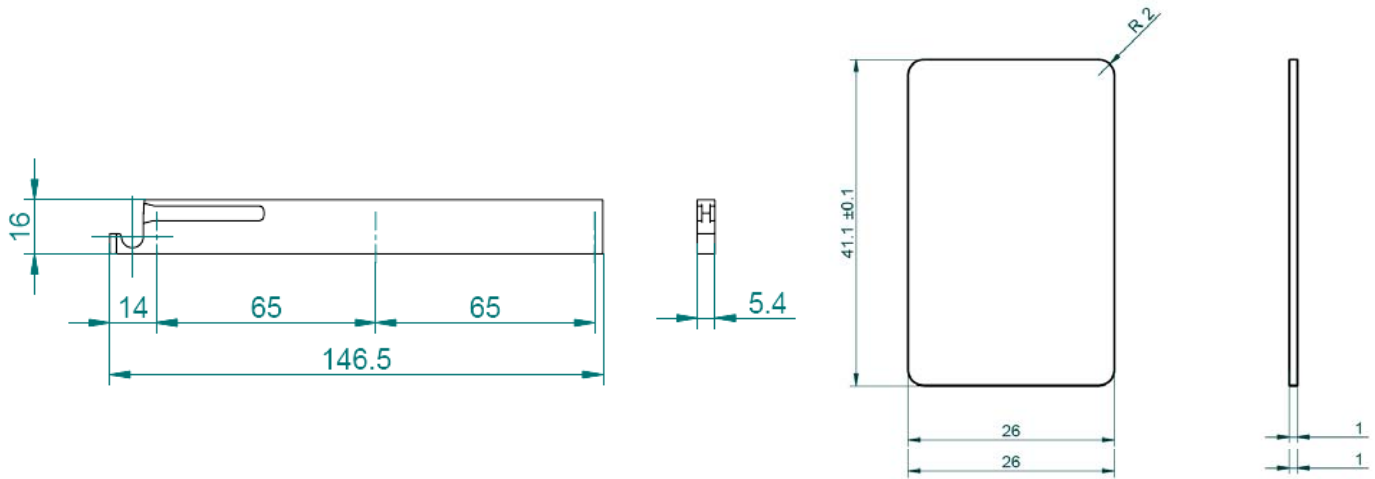

I²C to USB Interface HZZ02002G:

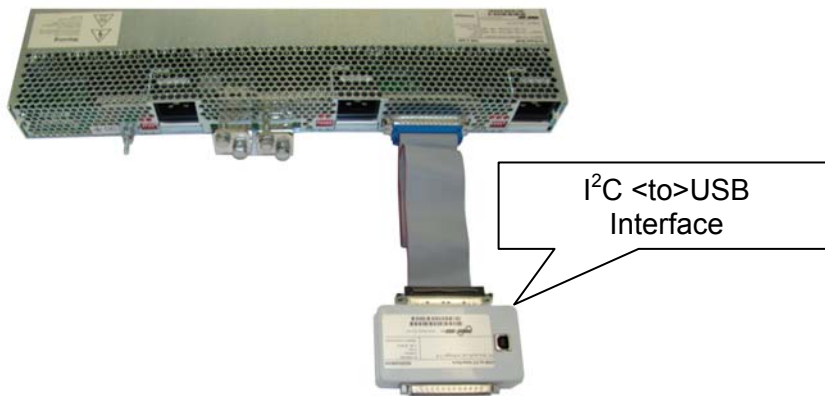

I²C Management Software: All FXP front-ends can be controlled via Power-One's GUI-driven I²C Management software and an I²C-to-USB interface (P/N HZZ02002G). An I²C Programming Manual describes the complete range of parameters that can be programmed to the FXP1500/1800 front-ends. This manual is available by searching on "FXP1500" at www.power-one.com.

NUCLEAR AND MEDICAL APPLICATIONS - Power-One products are not designed, intended for use in, or authorized for use as critical components in life support systems, equipment used in hazardous environments, or nuclear control systems without the express written consent of the respective divisional president of Power-One, Inc.

TECHNICAL REVISIONS - The appearance of products, including safety agency certifications pictured on labels, may change depending on the date manufactured. Specifications are subject to change without notice.