

1

2

3

4

5

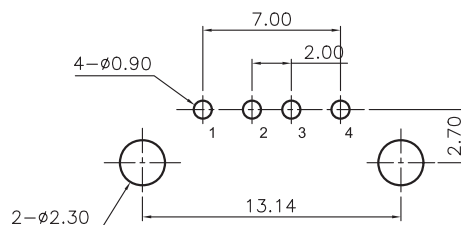
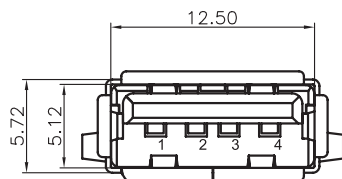
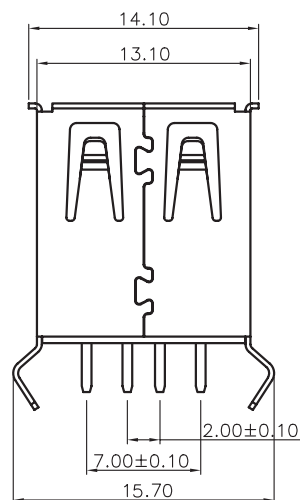
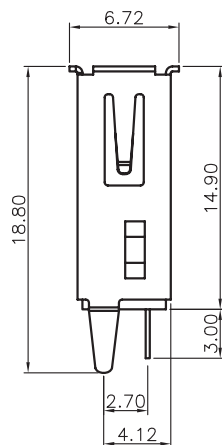

PCB LAYOUT - COMPONENT VIEW

## TECHNICAL CHARACTERISTICS

MATERIAL  
 INSULATOR: PBT  
 FLAMMABILITY RATING: UL94-V0  
 COLOR: WHITE  
 CONTACT MATERIAL: COPPER ALLOY  
 CONTACT TYPE: STAMPED  
 CONTACT PLATING: SELECTIVE GOLD  
 SHIELDING: BRASS Ni PLATED  
 QUALITY CLASS: 1500 MATING CYCLES

ENVIRONMENTAL  
 OPERATING TEMPERATURE: -40°C UP TO +105°C  
 COMPLIANCE: LEAD FREE AND ROHS

ELECTRICAL  
 CURRENT RATING: 1.5 A MAX  
 WORKING VOLTAGE: 30 VAC  
 INSULATOR RESISTANCE: >1000 MΩ  
 DIELECTRIC WITHSTANDING VOLTAGE: 750 VAC/MIN  
 CONTACT RESISTANCE: 20 mΩ MAX

STANDARD  
 CERTIFIED: E323964

SOLDERING  
 JEDEC LEAD FREE WAVE SOLDERING

PACKAGING  
 TRAY

RoHS Compliant

PROJECTION:



GENERAL TOLERANCE

.X =  $\pm 0.2$ .XX =  $\pm 0.15$ 

APPROVAL: NPr

UNIT: MM

SCALE:

SHEET: 1/2



DRAW: QL

DESCRIPTION: USB 2.0 TYPE A VERTICAL

WERI PART NO: 614 004 135 023

SIZE

**A4**

RoHS Compliant				PROJECTION:	GENERAL TOLERANCE		DESCRIPTION: USB 2.0 TYPE A VERTICAL	SIZE
L	27-OCT-14	REVIEW	QL		.X = $\pm 0.2$			
K	12-AUG-13	UPDATE	QL		.XX = $\pm 0.15$			
J	15-FEB-13	DESIGNATION	AR					
I	19-DEC-11	DRAWING	GG					
H	08-NOV-11	CURRENT RATING	GG					
REV	DATE	FILE	BY					

1

2

3

4

5

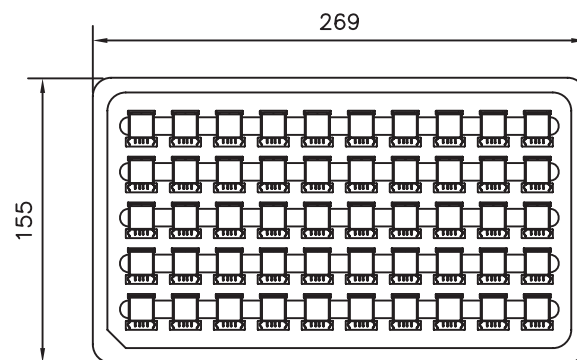
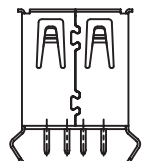
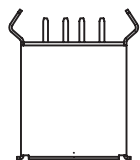

Note:

1.Dimension:

Tray Size: 269(L)X155(W)X8.0(H) (mm)

Carton Size:322X285X350(mm)

Pin.	Pcs/Tray	Tray/Carton	Pcs/Carton
04	50	70	3500

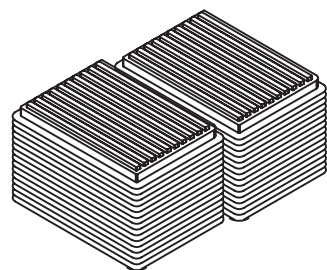

84 Trays

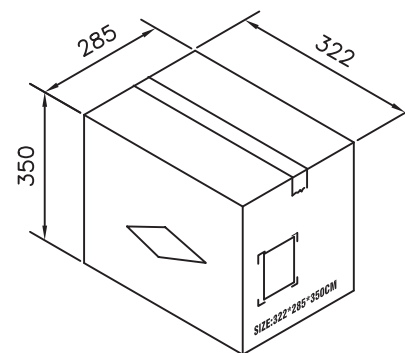

RoHS Compliant

PROJECTION:



GENERAL TOLERANCE

.X =  $\pm$  0.2.XX =  $\pm$  0.15

WÜRTH ELEKTRONIK

APPROVAL: NP

UNIT: MM

SCALE:

SHEET: 2/2

DRAW: QL

DESCRIPTION: USB TYPE A VERTICAL

WERI PART NO: 614 004 135 023

SIZE

A4

G			
F			
E			
D			
C			
B			
A			
REV	DATE	FILE	BY