

Signal conditioner - MINI MCR-2-I0-U-PT - 2902001

Please be informed that the data shown in this PDF Document is generated from our Online Catalog. Please find the complete data in the user's documentation. Our General Terms of Use for Downloads are valid (<http://phoenixcontact.com/download>)



3-way signal conditioner with plug-in connection technology for the electrical isolation of analog signals. Input signal: 0 ... 20 mA, output signal: 0 ... 10 V, push-in connection technology

The figure shows the MINI MCR-2-U-I0-PT version

Product description

Standard signal 3-way signal conditioner with plug-in connection technology for the electrical isolation, conversion, amplification, and filtering of standard signals. The measuring transducer supports fault monitoring and NFC communication.



Key commercial data

Packing unit	1 pc
Weight per Piece (excluding packing)	97.4 GRM
Custom tariff number	85437090
Country of origin	Germany

Technical data

Note

Utilization restriction	EMC: class A product, see manufacturer's declaration in the download area
-------------------------	---

Dimensions

Width	6.2 mm
Height	110.5 mm
Depth	120.5 mm

Ambient conditions

Ambient temperature (operation)	-40 °C ... 70 °C
Ambient temperature (storage/transport)	-40 °C ... 85 °C

Signal conditioner - MINI MCR-2-I0-U-PT - 2902001

Technical data

Ambient conditions

Degree of protection	IP20
----------------------	------

Input data

Number of inputs	1
Configurable/programmable	no
Current input signal	0 mA ... 20 mA
Input resistance current input	approx. 63 Ω

Output data

Number of inputs	1
Configurable/programmable	no
Voltage output signal	0 V ... 10 V
Max. output voltage	11 V
Short-circuit current	< 15 mA
Load/output load voltage output	\geq 10 k Ω

Power supply

Nominal supply voltage	24 V DC
Supply voltage range	9.6 V DC ... 30 V DC (The DIN rail bus connector (ME 6,2 TBUS-2 1,5/5-ST-3,81 GN, Order No. 2869728) can be used to bridge the supply voltage. It can be snapped onto a 35 mm DIN rail according to EN 60715))
Typical current consumption	25 mA (at 24 V DC) 54 mA (at 12 V DC)
Power consumption	\leq 200 mW (at 9.6 V DC)

Connection data

Connection method	Push-in connection
Single conductor/terminal point, solid, with ferrule, min.	0.14 mm ²
Single conductor/terminal point, solid, with ferrule, max.	2.5 mm ²
Single conductor/terminal point, solid, without ferrule, min.	0.14 mm ²
Single conductor/terminal point, solid, without ferrule, max.	2.5 mm ²
Conductor cross section stranded min.	0.14 mm ²
Conductor cross section stranded max.	2.5 mm ²
Min. AWG conductor cross section, stranded	24
Max. AWG conductor cross section, stranded	12
Stripping length	10 mm

General

Maximum transmission error	0.1 % (of final value)
Maximum temperature coefficient	0.01 %/K
Limit frequency (3 dB)	approx. 30 Hz

Signal conditioner - MINI MCR-2-I0-U-PT - 2902001

Technical data

General

Step response (10-90%)	approx. 10 ms
Protective circuit	Transient protection
Electrical isolation	Reinforced insulation in accordance with IEC 61010-1
Surge voltage category	II
Pollution degree	2
Rated insulation voltage	300 V
Test voltage, input/output/supply	3 kV (50 Hz, 1 min.)
Electromagnetic compatibility	Conformance with EMC Directive 2004/108/EC
Noise emission	EN 61000-6-4
Noise immunity	EN 61000-6-2 When being exposed to interference, there may be minimal deviations.
Color	gray
Housing material	PBT
Mounting position	any
Assembly instructions	The T connector can be used to bridge the supply voltage. It can be snapped onto a 35 mm DIN rail according to EN 60715.
Conformance	CE-compliant
ATEX	# II 3 G Ex nA IIC T4 Gc X
UL, USA / Canada	UL 508 Listed
	Class I, Div. 2, Groups A, B, C, D T6
	Class I, Zone 2, Group IIC T6
GL	GL applied for

EMC data

Designation	Electromagnetic RF field
Standards/regulations	EN 61000-4-3
Designation	Fast transients (burst)
Standards/regulations	EN 61000-4-4
Designation	Conducted interferences
Standards/regulations	EN 61000-4-6

Classifications

eCl@ss

eCl@ss 4.0	27040702
eCl@ss 4.1	27040702
eCl@ss 5.0	27242213
eCl@ss 5.1	27049002

Signal conditioner - MINI MCR-2-I0-U-PT - 2902001

Classifications

eCl@ss

eCl@ss 6.0	27049002
eCl@ss 7.0	27049002
eCl@ss 8.0	27210120

ETIM

ETIM 3.0	EC001039
ETIM 4.0	EC002540
ETIM 5.0	EC002653

UNSPSC

UNSPSC 6.01	30211502
UNSPSC 7.0901	39121004
UNSPSC 11	39121004
UNSPSC 12.01	39121004
UNSPSC 13.2	39121004

Approvals

Approvals

Approvals

UL Listed / cUL Listed / cULus Listed

Ex Approvals

ATEX / UL Listed / cUL Listed / cULus Listed

Approvals submitted

Approval details

UL Listed 

Signal conditioner - MINI MCR-2-I0-U-PT - 2902001

Approvals

cUL Listed

cULus Listed

Drawings

Pictogram



Block diagram

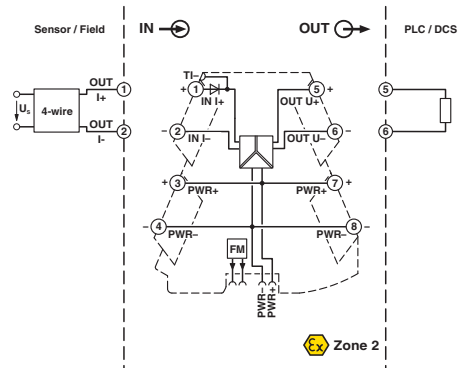

Pictogram

Pictogram

