

BTL6-A110-M0160-A1-S115
Ordering code: BTL0026

Micropulse transducers
Series Profile

Output signal 0...10 V and 10...0 V
Nominal stroke 160 mm

BALLUFF
sensors worldwide

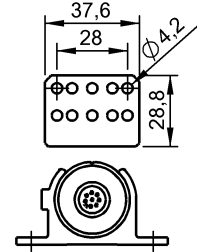
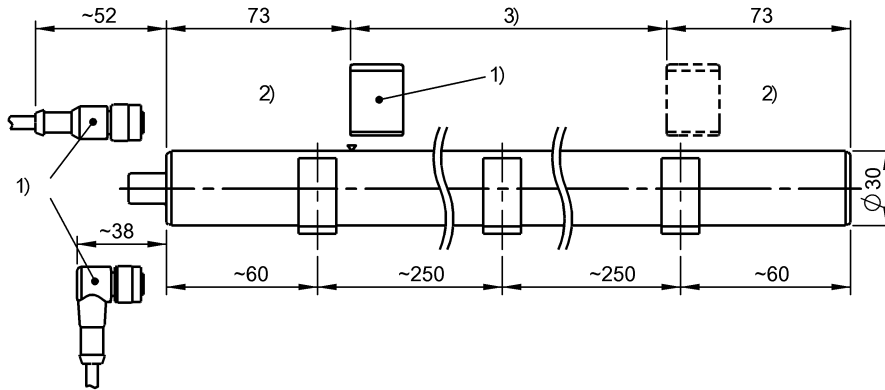

Pin	
1	GND output
2	GND output
3	10...0 V
4	NC
5	0...10 V
6	GND
7	+24 V DC
8	NC

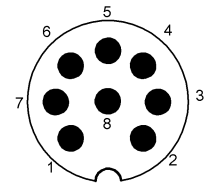

1) Not incl. in scope of del., 2) Unusable area, 3) Nom. stroke = Meas. length

Characteristic data

Output signal 0...10 V and 10...0 V
 Connection Connector, M12
 Operating voltage 20...28 V DC

Electrical data

Ripple 0.5 Vpp
 Current consumption (at 24 V DC) ≤ 70 mA
 Inrush current ≤ 3 A / 0.5 ms
 Overvoltage protected Yes
 Voltage-proof (GND – housing) 500 V DC
 Ripple Ua max. 5
 Galvanic isolation No
 For dynamic loop applications No
 Error signal Ua rising ≥ 10.2 V
 Error signal Ua falling ≥ 10.2 V

Mechanical data

Version Type A1
 Mounting type Mounting clamps
 Connector type M12
 Cable/connector out Axial
 Number of pins 8
 Housing material Anodized aluminum
 Resolution ≤ 10 µm
 Repeat accuracy ≤ 10 µm

Sampling rate (length-depend.) 1 kHz, standard
 TK, typ. (at 50% of 500 mm) ≤ 35 ppm/K
 Ambient temperature Ta min. 0 °C
 Ambient temperature Ta max. 70 °C
 Storage temperature min. -40 °C
 Storage temperature max. 100 °C
 Relative humidity < 90%, non-condensing
 Null point 73 mm

Basic data

Protected against polarity reversal
 Enclosure Type per IEC 60529
 EN 60068-2-27 (shock)
 EN 60068-2-29 (cont. shock)
 EN 60068-2-6 (vibration)
 EN 60068-2-64 (noise)
 EN 55016-2-3 (emission)
 EN 61000-4-2 (ESD)
 EN 61000-4-3 (RFI)
 EN 61000-4-4 (burst)
 EN 61000-4-5 (surge)
 EN 61000-4-6 (HF fields)
 EN 61000-4-8 (magnetic fields)
 Approvals

Up to 36 V
 IP67 (with connector)
 50 g / 6 ms
 50 g / 2 ms
 12 g, 10...2000 Hz
 5 g, 10...2000 Hz
 Class A+B
 Severity Level 3
 Severity Level 3
 Severity Level 3
 Severity Level 2
 Severity Level 3
 Severity Level 4
 CE, cURus

Remarks

BTL6-A110-M0160-A1-S115
Ordering code: BTL0026

Micropulse transducers
Series Profile

Output signal 0...10 V and 10...0 V
Nominal stroke 160 mm

BALLUFF
sensors worldwide

