

Features

- Uniform light emitting area.
- Low current operation.
- Easily mounted on P.C. boards.
- Flush mountable.
- Excellent on/off contrast.
- Can be used with panels and legend mounts.
- RoHS compliant.

Description

The Super Bright Orange device is made with AlGaInP (on GaAs substrate) light emitting diode chip.

Package Dimensions & Internal Circuit Diagram

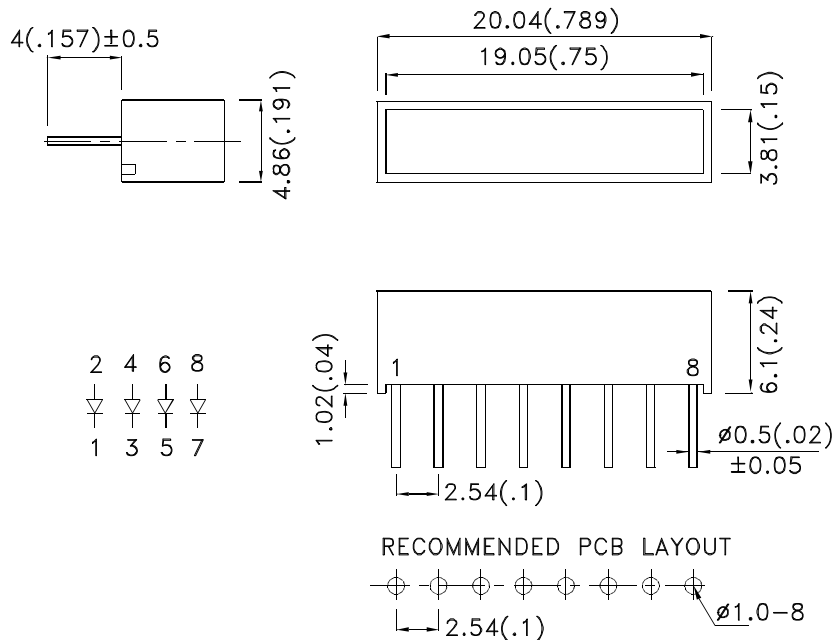

Notes:

1. All dimensions are in millimeters (inches), Tolerance is $\pm 0.25(0.01)$ unless otherwise noted.
2. The specifications, characteristics and technical data described in the datasheet are subject to change without prior notice.



Selection Guide

Part No.	Dice	Lens Type	Iv (mcd) [1] @ 20mA	
			Min.	Typ.
KB-2350SEKW	Super Bright Orange (AlGaInP)	WHITE DIFFUSED	180	400

Note:

- Luminous intensity/ luminous Flux: +/-15%.

Electrical / Optical Characteristics at TA=25°C

Symbol	Parameter	Device	Typ.	Max.	Units	Test Conditions
λ_{peak}	Peak Wavelength	Super Bright Orange	610		nm	I _F =20mA
λ_D [1]	Dominant Wavelength	Super Bright Orange	601		nm	I _F =20mA
$\Delta\lambda_{1/2}$	Spectral Line Half-width	Super Bright Orange	29		nm	I _F =20mA
C	Capacitance	Super Bright Orange	15		pF	V _F =0V;f=1MHz
V _F [2]	Forward Voltage	Super Bright Orange	2.1	2.5	V	I _F =20mA
I _R	Reverse Current	Super Bright Orange		10	uA	V _R =5V

Notes:

- Wavelength: +/-1nm.
- Forward Voltage: +/-0.1V.

Absolute Maximum Ratings at TA=25°C

Parameter	Super Bright Orange	Units
Power dissipation	75	mW
DC Forward Current	30	mA
Peak Forward Current [1]	195	mA
Reverse Voltage	5	V
Operating / Storage Temperature	-40°C To +85°C	
Lead Solder Temperature[2]	260°C For 3-5 Seconds	

Notes:

- 1/10 Duty Cycle, 0.1ms Pulse Width.
- 2mm below package base.

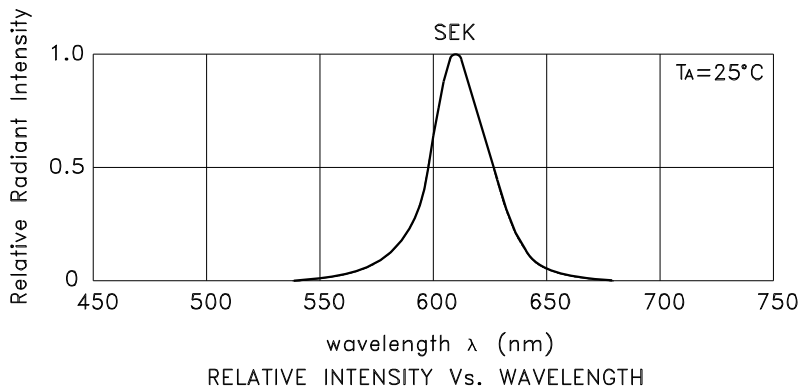

Super Bright Orange KB-2350SEKW

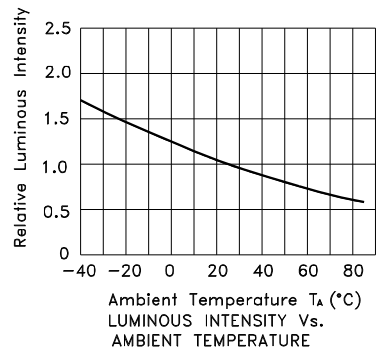
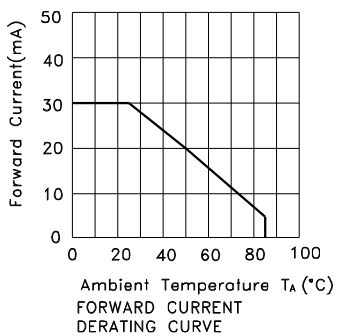
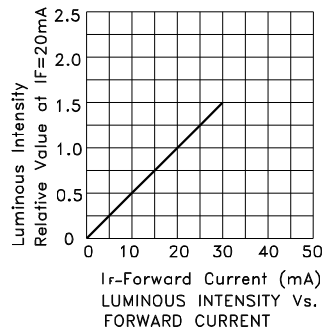
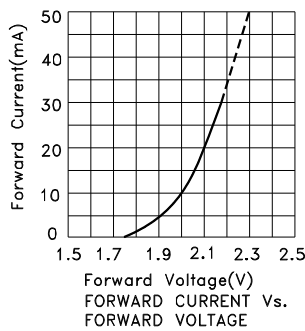

PACKING & LABEL SPECIFICATIONS

KB-2350SEKW

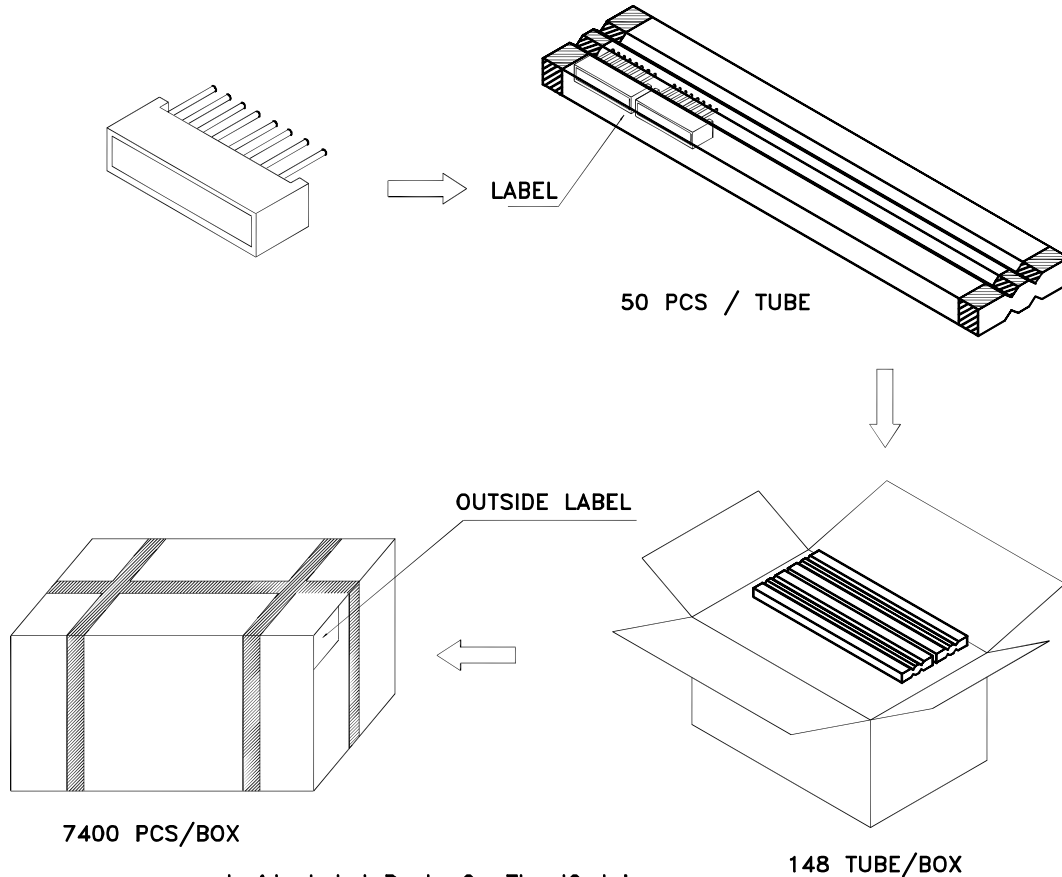

Inside Label Paste On The IC-tube

Kingbright	TYPE: KB-2350xxx	Date
	QTY: 50 PCS CODE: xx	PASSED xx xx xx FQCX
XXXXXXXXXX-XXXX	RoHS Compliant	Number OF FQC
LOT NO.		

Outside Label Paste On The Box

XXXXXX	XXXXXXXXXX-XXXX	Bin Code	Number OF QA
KB-2350xxx	XX	QAx xx xx xx PASSED	Date
7400 PCS	RoHS Compliant		