



Main

Range of product	Modicon TM5
Product or component type	Analog output module
Analogue output number	2
Analogue output resolution	12 bits 0...20 mA 12 bits + sign +/- 10 V

Complementary

Range compatibility	Modicon LMC058 Modicon M258
Product compatibility	Motion controller Logic controller
Analogue output type	Voltage +/- 10 V Current 0...20 mA
Measurement resolution	9.766 µA, 0...20 mA 4.882 mV, +/- 10 V
Colour	White
Response time	<= 1 ms
Output impedance	>= 1 Ohm
Load impedance ohmic	<= 500 Ohm (current
Sampling duration	200 µs
Measurement error	< 0.15 % of full scale, 0...20 mA at 25 °C < 0.15 % of full scale, +/- 10 V at 25 °C
Temperature coefficient	0.02 %FS/°C, analogue output type: voltage 0.02 %FS/°C, analogue output type: current
Non-linearity	< 0.007 %FS, analogue output type: voltage < 0.007 %FS, analogue output type: current
Type of cable	Shielded cable
Isolation	No insulation between channels 500 Vrms AC insulation between channel and bus
Supply	Internal
[Us] rated supply voltage	24 V DC -15...20 %
Local signalling	2 LEDs yellow for output status 1 LED red for power supply 1 LED green for power supply
Current consumption	46 mA 24 V DC input/output 2 mA 5 V DC bus
Power dissipation in W	<= 1.11 W
Marking	CE
Product weight	0.025 kg

Environment

Standards	CSA 22-2 No 142 IEC 61131-2 UL 508 CSA 22-2 No 213
Product certifications	CSA C-Tick CULus GOST-R
Ambient air temperature for operation	0...60 °C with derating factor (horizontal installation) 0...55 °C without derating factor (horizontal installation) 0...50 °C (vertical installation)
Ambient air temperature for storage	-25...70 °C
Relative humidity	5...95 % without condensation
IP degree of protection	IP20 conforming to IEC 61131-2
Pollution degree	2 conforming to IEC 60664
Operating altitude	0...2000 m
Storage altitude	0...3000 m
Vibration resistance	3.5 mm (f= 5...8.4 Hz) DIN rail 1 gn (f= 8.4...150 Hz) DIN rail
Shock resistance	15 gn for 11 ms
Resistance to electrostatic discharge	8 kV in air conforming to EN/IEC 61000-4-2 4 kV on contact conforming to EN/IEC 61000-4-2
Resistance to electromagnetic fields	10 V/m 80...2000 MHz conforming to EN/IEC 61000-4-3 1 V/m 2...2.7 GHz conforming to EN/IEC 61000-4-3
Resistance to fast transients	2 kV power lines conforming to EN/IEC 61000-4-4 1 kV shielded cable conforming to EN/IEC 61000-4-4 1 kV I/O conforming to EN/IEC 61000-4-4
Surge withstand	1 kV common mode conforming to EN/IEC 61000-4-5 0.5 kV differential mode conforming to EN/IEC 61000-4-5
Electromagnetic compatibility	EN/IEC 61000-4-6
Disturbance radiated/conducted	CISPR11

Offer Sustainability

Sustainable offer status	Not Green Premium product
RoHS	Compliant - since 1039 - Schneider Electric declaration of conformity download declaration of conformity

TM5 Slice

Dimensions

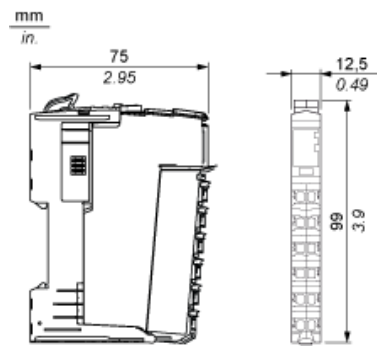

TM5 System

Spacing Requirements

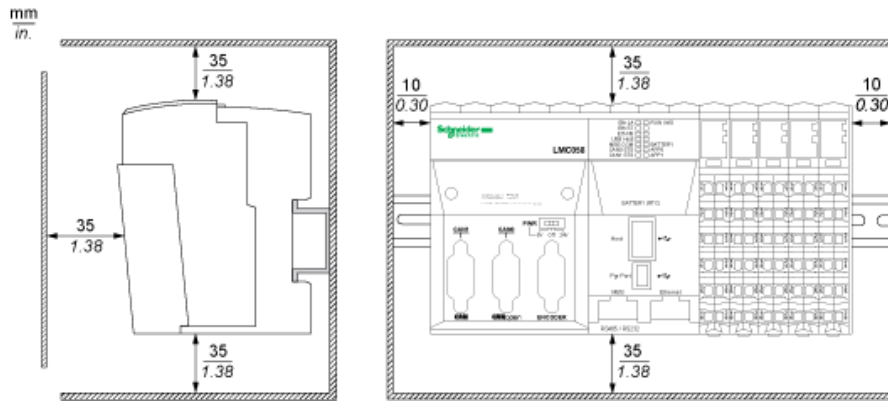



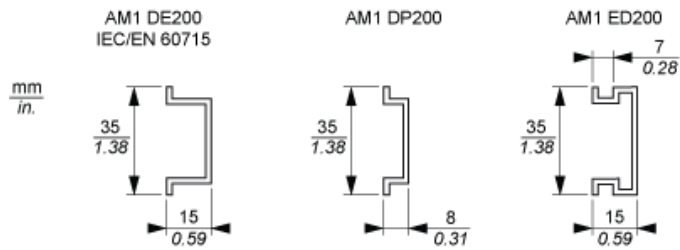

Mounting on a DIN Rail



TM5 System Wiring Recommendations

Wire Sizes to Use with the Removable Spring Terminal Blocks

mm in.				
mm ²	0,08...2,5	0,25...2,5	0,25...1,5	2 x 0,25...2 x 0,75
AWG	28...14	24...14	24...16	2 x 24...2 x 18

Electronic Module 2AO ±10V/0-20mA 12 Bits

Wiring Diagram

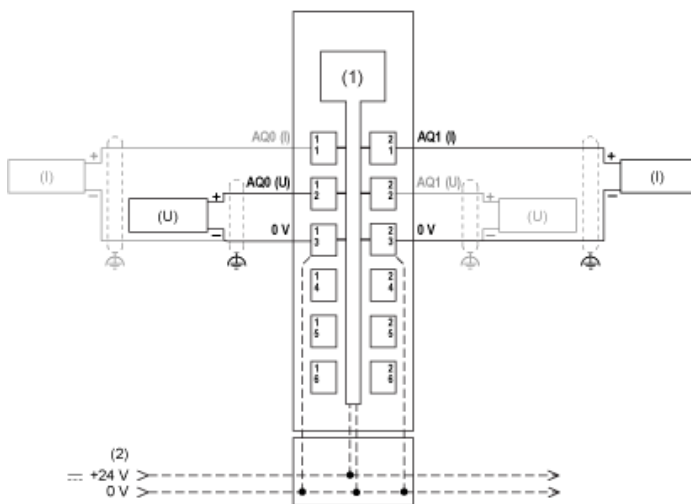

- (1) Internal electronics
- (2) 24 Vdc I/O power segment integrated into the bus bases
- (I) Current
- (U) Voltage