



KRAUS & NAIMER
BLUE LINE SWITCHGEAR

www.krausnaimer.com

SINCE 1907

Catalog 100

CL Switches 10 A-20 A

C, CA, CAD Switches 10 A-315 A

L Switches 350 A-2400 A



KRAUS & NAIMER

The development of the Blue Line rotary switch, contactor and motor starter product ranges is based on more than seventy-five years experience by Kraus & Naimer in the design and manufacture of electrical switchgear. Kraus & Naimer pioneered the introduction of the cam operated rotary switch and continues to be recognized as the world leader in that product field.

BLUE LINE

Blue Line products are protected by numerous patents throughout the industrial world. They are built to national and international standards and designed to withstand adverse temperatures and climates.

Blue Line products are accepted and universally recognized for their quality and workmanship. They are supported by a worldwide sales and service organization.

The Kraus & Naimer Registered Trademark

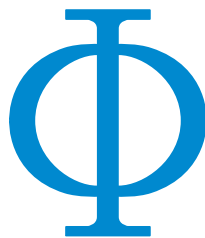

WORLDWIDE SYMBOL
FOR QUALITY SWITCHGEAR

Disconnectors and Main Switches acc. to IEC 60947-3 see Catalog 500

Contents	Page
Construction Data	2
Dimensions and Nominal Ratings	3
How to order	4, 5
Switch Function and Configuration	
CL Switches 10 A-20 A	
C, CA and CAD Switches 10 A-315 A	
ON/OFF Switches	6, 7
Double-throw Switches	8-10
General Application Switches	10
Coding Switches	11
Multi-step Switches	12-14
Voltmeter Switches	15-17
Ammeter Switches	17-19
Volt-ammeter Switches	19
Control Switches	19, 20
Motor Switches	21-23
L Switches 350 A-2400 A	
ON/OFF Switches	24-26
Double-throw Switches	26, 27
Multi-step Switches	27, 28
Types of Mounting	
Panel Mounting	29-33
Base Mounting	34
Wall Mounting	35
Escutcheon Plates	36, 37
Handles	38
International Standards and Approvals	39
Technical Data	40-43
Dimensions	
Panel Mounting	44-48
Base Mounting	48, 49
Wall Mounting	50
Overall Switch Lengths	50, 51
Blue Line Switchgear: Summary	52

Construction Data

The load switches of the C, CA, CAD and CL-series offer a solution for most cam switch applications. Different contact designs, contact materials and terminals allow for their use as control switches, instrumentation switches and motor control switches, as well as in electronic circuitry and in aggressive environments according to IEC 60947-3 and VDE 0660 part 107.

The stage is the basis for all switches and can be supplied with a maximum of 2 contacts. The terminals are accessible from the side. CA and CAD switches are supplied with open terminals to facilitate wiring and are protected against accidental finger contact according to EN 50274, VDE 0660 part 514 and BGV A3. Switches up to type CA25B are supplied with captive screws with clamping plates. The switch types CA40-CA63 are supplied with box terminals. Captive plus-minus terminal screws and integrated screwdriver guides facilitate wiring.

The switches of the new CL-series are supplied with rust-free and acid-resisting IDC terminals (Insulation Displacement Connection) instead of screw type terminals. The stripping or preparation of the insulation is no longer required. Eliminate errors due to i.e., stripped end of the conductor too long or too short, incorrect sleeves used, sleeves crimped incorrectly or wrong crimping tool is used, terminal screws not tightened properly etc. The CL switches reduce installation time by 60 %-70 % compared to the screw type terminals. This translates to significant cost savings. For connecting 2 conductors to a terminal an additional screw terminal with plus-minus screw is available.

If a positive manual operation or a higher DC rating is required, many of these switches can be fitted with a snap action latching mechanism - suffix „S“ - to the switch type.

The cam-operated switches of the L-series are continuous current rated for off-load switching. They may be used to switch resistive or low inductive loads.

Special Contact Systems

CA4/CA4-1

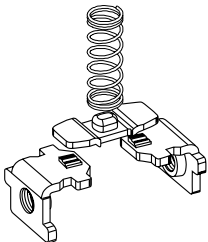

High contact reliability by multiple cross-point contacts, electronic compatible, CA4 with 1 μ and CA4-1 with 35 μ gold plating.

CAD11/CAD12

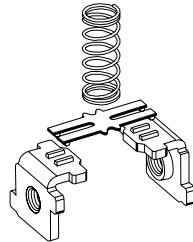

H-bridge with „cross-wire“ contact system, high contact reliability also at lower voltages. CAD11 with gold-plated contacts, CAD12 with silver contact.

CL Switches



CA and CAD Switches (CA4-CA25B)



CA Switches (CA40-CA63)



C Switches



L Switches

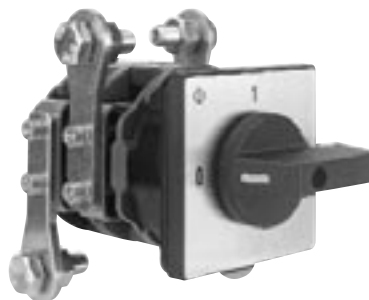

Above illustrates the standard terminal positions.

Type	Size	Possible Switching Angles	Max. No. of Stages
CA4, CA4-1	S00	30°, 45°, 60°, 90°	9
CL4	S00	30°, 45°, 60°, 90°	8
CA10-CA25	S0	30°, 45°, 60°, 90°	12
CA10S-CA25S	S0	60°	on request
CAD11, CAD12	S0	30°, 45°, 60°, 90°	12
CL10	S0	30°, 45°, 60°, 90°	10
CA10B-CA25B	S1	30°, 45°, 60°, 90°	12
CA40, CA50, CA63	S1	30°, 45°, 60°, 90°	12
C80, C125	S2	20°, 30°, 45°, 60°, 90°	12
C315	S3	20°, 30°, 45°, 60°, 90°	12
L350/51, L630/31, L1000/01, L1250/51	S2	30°, 45°, 60°, 90°	12
L400, L600, L800, L1200, L1600, L2000	S3	30°, 45°, 60°, 90°	12

Nominal Ratings

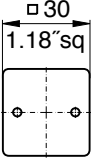
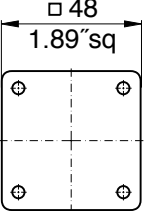
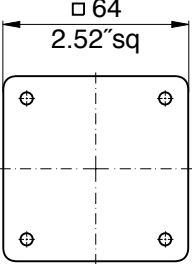
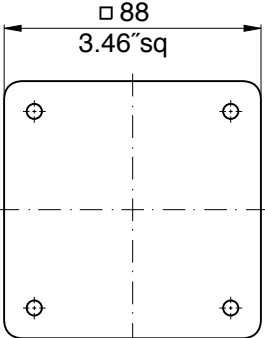
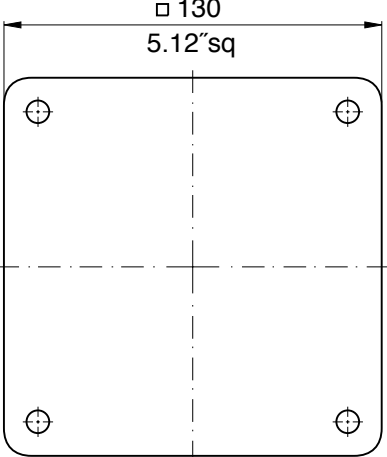
Switch Size	Type	According to IEC 60947-3/VDE 0660 part 107			
		Insulation Voltage ¹ U_i V	Thermal Current I_U/I_{th} A	Motor Rating 3 x 380 V-440 V AC-23 AC-3 kW kW	
S00 	CA4	440	10	3	2,2
	CA4-1	440	10	3	2,2
	CL4	440	10	3	2,2
S0 	CA10	690	20	7,5	5,5
	CA11	690	20	7,5	5,5
	CA20	690	25	11	7,5
	CA25	690	32	15	11
	CAD11	600	6	-	-
	CAD12	600	6	-	-
	CL10	690	20	7,5	5,5
S1 	CA10B	690	20	7,5	5,5
	CA11B	690	20	7,5	5,5
	CA20B	690	25	11	7,5
	CA25B	690	32	15	11
	CA40	690	40	18,5	15
	CA50	690	50	22	18,5
	CA63	690	63	30	18,5
S2 	C80	690	115	45	30
	C125	690	150	75	37
	L350	690	350	90	37
	L351	690	350	90	37
	L630	690	630 ²	90	37
	L631	690	630 ²	90	37
	L1000	690	1000 ²	90	37
	L1001	690	1000 ²	90	37
	L1250	690	1250 ²	90	37
	L1251	690	1250 ²	90	37
S3 	C315	690	315	132	55
	C316³	1000	315	132	55
	L400	690	500	132	55
	L600	690	800 ²	132	55
	L800	690	1100 ²	132	55
	L1200	690	1450 ²	132	55
	L1600	690	1900 ²	132	55
	L2000	690	2400 ²	132	55

For further technical details, refer to pages 40-43.
To furnish with gold contacts and quick connects see page 4.

¹Valid for lines with grounded common neutral termination, overvoltage category III, pollution degree 3. Values for other supply systems on request. ²Ambient temperature 35 °C max. ³Additional switch functions on request.

How to order

Disconnectors and Main Switches according to IEC 60947-3 see Catalog 500

Three types of data (shown below) are required for ordering Blue Line cam-operated switches. Code numbers for ordering are shown in this catalog.

1. Type of Switch

The type of switch required may be easily selected by referring to the table on page 3 which shows the thermal current, power rating and dimensions of each switch. For further technical details, refer to pages 40-43. Variations of contacts and terminals are shown below.

2. Switch Function

The code numbers for standard switches shown on pages 6-28 indicate the switch function, escutcheon plate, handle and any optional extras.

Additional coding to modify type and color of handle and escutcheon plate is explained below.

3. Type of Mounting

Types of mounting are shown on pages 29-35. Catalog **101** describes enclosures and optional extras.

Specify the mounting code to indicate required mounting.

CA10

A202-600

VE

Type of Switch

Extending the switch type coding the following combinations will define:

Amendment	Definition	For switch types
-1	with gold contacts ¹	CA10, CA11, CA10B, CA11B
-4	with quick connects	CA4
B	S0 switches with latching mechanism size S1	CA10, CA11, CA20, CA25, CAD12
C	S1 switches with latching mechanism size S2	CA40 ² , CA50 ² , CA63 ²
L	with lockout-relay w/o manual release for std. sw.	CA10, CA40 ² , CA50 ² , CA63 ²
M	with lockout-relay with manual release for std. sw.	CA10, CA40 ² , CA50 ² , CA63 ²
X	with power failure release	CA10, CA11, CA20, CA25, CAD12, CA40 ² , CA50 ² , CA63 ²
Y	with power failure release and trip-free release	CA10, CA11, CA20
S	with snap action	CA10, CA11, CA20, CA25, CA40 ² , CA50 ² , CA63 ²
R	with spring return latching mechanism	CA10

Example: Coding for switch type **CA10** with gold contacts is **CA10-1**.

Modification of Switches

The part number for switch function and options may be modified in cases where items are required other than standard. The modification may involve the escutcheon plate inscription, color combination of escutcheon plate and handle, type of escutcheon plate and handle or the optional extra.

Switch Size	Escutcheon Plate Frame	Handle	Escutcheon Plate Backing	Escutcheon Plate Lettering	Dash Number
S0, S1, S2, S3	electro-gray	electro-gray	brushed alu	black	-100
S0, S1, S2, S3	electro-gray	electro-gray	black	mat silver	-500
S00, S0, S1, S2, S3	black	black	brushed alu	black	-600
S00, S0, S1, S2, S3	black	black	black	mat silver	-700

Function	Escutch. Plate	Type/Handle				Code	Stages	Connection Diagram
		CA4 CA4-1 CL4	CAD.. CA10- CA25 CL10	CA10B- CA25B	CA40 C315			

ON/OFF Switches with 60° Switching

1 pole 2 pole 3 pole 3 pole with red handle 3 pole with V850 padlock attachment						A200-600 A201-600 A202-600 A202-626 A202-627	1 1 2 2 2	<p>1-12 pole</p>	
4 pole 4 pole 1 pole preclose 6° ¹ 5 pole 6 pole 7 pole 8 pole 8 pole 2 pole preclose 6° ¹ 9 pole 10 pole 11 pole 12 pole						A200-620 A201-620 A202-620 A203-620 A653-620 A341-620 A342-620 A343-620 A344-620 A654-620 A345-620 A346-620 A347-620 A348-620	1 1 2 2 3 3 4 4 4 4 5 6 6		
1 pole 2 pole 3 pole 4 pole 4 pole 1 pole preclose 6° ¹ 5 pole 6 pole 7 pole 8 pole 8 pole 2 pole preclose 6° ¹ 9 pole 10 pole 11 pole 12 pole						A200-621 A201-621 A202-621 A203-621 A653-621 A341-621 A342-621	1 1 2 2 2 3 3 3		<p>4 pole 1 pole preclose 6°</p>
1 pole 2 pole 3 pole 4 pole 4 pole 1 pole preclose 6° ¹ 5 pole 6 pole						A200-622 A201-622 A202-622 A203-622 A653-622 A341-622 A342-622	1 1 2 2 2 3 3		<p>8 pole 2 pole preclose 6°</p>
1 pole 2 pole 3 pole 4 pole 4 pole 1 pole preclose 6° ¹ 5 pole 6 pole						A200-623 A201-623 A202-623 A203-623 A653-623 A341-623 A342-623	1 1 2 2 2 3 3		
1 pole 2 pole 3 pole 4 pole 4 pole 1 pole preclose 6° ¹ 5 pole 6 pole						A200-624 A201-624 A202-624 A203-624 A653-624 A341-624 A342-624	1 1 2 2 2 3 3		
1 pole 2 pole 3 pole 4 pole 4 pole 1 pole preclose 6° ¹ 5 pole 6 pole						A200-625 A201-625 A202-625 A203-625 A653-625 A341-625 A342-625	1 1 2 2 2 3 3		

¹for use in a three phase four-wire system with switched neutral

Switch Function and Configuration

C, CA, CAD, CL Switches

Function	Escutch. Plate	Type/Handle				Code	Stages	Connection Diagram
		CA4 CA4-1 CL4	CAD.. CA10- CA25 CL10	CA10B- CA25B	CA40 C315			

ON/OFF Switches with 90° Switching

1 pole contacts						A290-600	1		1, 2, 3, 4, 5 and 6 pole			
2 pole preclose 30°						A291-600	1					
3 pole						A292-600	2					
4 pole						A324-600	2					
4 pole 1 pole preclose 60° ¹						A293-600	2					
4 pole 3 pole preclose 30°						A327-600	2					
5 pole contacts						A290-620	1		4 pole 1 pole preclose 60°			
2 pole preclose 30°						A291-620	1					
3 pole						A292-620	2					
4 pole						A324-620	2					
4 pole 1 pole preclose 60° ¹						A293-620	2					
4 pole 3 pole preclose 30°						A327-620	2					
5 pole contacts						A325-620	3				4 pole 3 pole preclose 30°	
6 pole preclose 30°						A326-620	3					
3 pole 360° rotation							A208-600			2		
										A208-620		
3 pole for foot operation						A386-600	2					

ON/OFF Switches with 30° Switching

1 pole						A100-600	1		1-4 pole
2 pole						A101-600	1		
3 pole						A102-600	2		
4 pole						A103-600	2		
1 pole with spring return						A204-600	1		1-4 pole
2 pole with spring return						A205-600	1		
3 pole with spring return						A206-600	2		
4 pole with spring return						A207-600	2		
1 pole with spring return						A204-620	1		1-4 pole
2 pole with spring return						A205-620	1		
3 pole with spring return						A206-620	2		
4 pole with spring return						A207-620	2		

¹for use in a three phase four-wire system with switched neutral ²not available for switch type CA25

Function	Escutch. Plate	Type/Handle				Code	Stages	Connection Diagram
		CA4 CA4-1 CL4	CAD.. CA10- CA25 CL10	CA10B- CA25B	CA40 C315			

Double-throw Switches without „OFF“ 60° Switching

1 pole						A220-600	1	
2 pole						A221-600	2	
3 pole						A222-600	3	
4 pole						A223-600	4	
4 pole 1 pole preclose 6° ³						A673-600	4	
5 pole						A369-600	5	
6 pole						A370-600	6	
7 pole						A371-600	7	
8 pole						A372-600	8	
8 pole 2 pole preclose 6° ³						A972-600	8	
9 pole						A373-600	9	
10 pole						A374-600	10	
11 pole					A375-600	11		
12 pole					A376-600	12		

Double-throw Switches without „OFF“ with electrically isolated contacts

1 pole						A720-600	1	
2 pole						A721-600	2	
3 pole						A722-600	3	
4 pole						A723-600	4	
4 pole 1 pole preclose 6° ³					A973-600	4		
1 pole with spring return						A795-600	1	

Double-throw Switches without „OFF“ 30° Switching

1 pole						A120-600	1	
2 pole						A121-600	2	
3 pole						A122-600	3	
4 pole						A123-600	4	
1 pole with spring return						A295-600	1	
2 pole with spring return						A296-600	2	
3 pole with spring return						A297-600	3	
1 pole with spring return						A295-620	1	
2 pole with spring return						A296-620	2	
3 pole with spring return						A297-620	3	

¹not available for switch type CA25 ²not available for switch type CL4 ³for use in a three phase four-wire system with switched neutral
⁴not available for switch type CL10

Switch Function and Configuration

C, CA, CAD, CL Switches

Function	Escutch. Plate	Type/Handle				Code	Stages	Connection Diagram
		CA4 CA4-1 CL4	CAD.. CA10- CA25 CL10	CA10B- CA63	C80- C315			

Double-throw Switches with Center „OFF“ 60° Switching

1 pole 2 pole 3 pole 4 pole 4 pole 1 pole preclose 6° ³ 5 pole 6 pole 7 pole 8 pole 8 pole 2 pole preclose 6° ³						A210-600 A211-600 A212-600 A213-600 A913-600 A361-600 A362-600 A363-600 A364-600 A664-600	1 2 3 4 4 5 6 7 8 8	
1 pole 2 pole 3 pole 4 pole 4 pole 1 pole preclose 6° ³ 5 pole 6 pole 7 pole 8 pole 8 pole 2 pole preclose 6° ³						A210-620 A211-620 A212-620 A213-620 A913-620 A361-620 A362-620 A363-620 A364-620 A664-620	1 2 3 4 4 5 6 7 8 8	
1 pole 2 pole 3 pole						A210-621 A211-621 A212-621	1 2 3	
1 pole 2 pole 3 pole						A210-622 A211-622 A212-622	1 2 3	
1 pole 2 pole 3 pole						A210-623 A211-623 A212-623	1 2 3	
1 pole 2 pole 3 pole 4 pole 4 pole 1 pole preclose 6° ³						A210-624 A211-624 A212-624 A213-624 A913-624	1 2 3 4 4	

Double-throw Switches with Center „OFF“ 90° Switching

1 pole 2 pole 3 pole 4 pole 1 pole preclose 60°						A218-600 A219-600 A299-600 A294-600	1 2 3 4	
1 pole 2 pole 3 pole 4 pole 1 pole preclose 60°						A218-620 A219-620 A299-620 A294-620	1 2 3 4	

Double-throw Switches with Center „OFF“ and electrically isolated contacts

1 pole 2 pole 3 pole 4 pole 4 pole 1 pole preclose 6° ³						A710-600 A711-600 A712-600 A713-600 A963-600	1 2 3 4 4	
1 pole with spring return 2 pole to center						A714-600 A715-600	1 2	

¹switch type C315 with handle ²not available for switch type C315 ³for use in a three phase four-wire system with switched neutral

Function	Escutch. Plate	Type/Handle				Code	Stages	Connection Diagram
		CA4 CA4-1 CL4	CAD.. CA10- CA25 CL10	CA10B- CA25B	CA40 C315			

Double-throw Switches with Spring Return to Center

1 pole with spring return to center						A214-600 A215-600 A216-600	1 2 3	<p>1-3 pole</p>
2 pole						A214-620 A215-620 A216-620	1 2 3	
3 pole								
1 pole with spring return from left to center						A320-600 A321-600 A322-600	1 2 3	<p>1-3 pole</p>
2 pole						A320-621 A321-621 A322-621	1 2 3	
3 pole								

General Application Switches

1 pole 2 Gang 2 pole Switching sequence: 3 pole 0, A, A+B						A310-600 A312-600 A314-600	1 2 3	<p>1 pole</p> <p>2 pole</p> <p>3 pole</p>
1 pole						A310-620 A312-620 A314-620	1 2 3	
2 pole								
3 pole								
1 pole 3 Gang 2 pole Switching sequence: 3 pole 0, A, A+B, A+B+C						A311-600 A313-600 A315-600	2 3 5	<p>1 pole</p> <p>2 pole</p> <p>3 pole</p>
1 pole						A311-620 A313-620 A315-620	2 3 5	
2 pole								
3 pole								
1 pole 2 Gang 2 pole Series switching 3 pole Switching sequence: 0, A, B, A+B						A330-600 A331-600 A332-600	1 2 3	<p>1 pole</p> <p>2 pole</p> <p>3 pole</p>
1 pole						A330-620 A331-620 A332-620	1 2 3	
2 pole								
3 pole								
2 pole 2 Gang Series-parallel Switching						A339-600	2	
Switching sequence: 0, A+B series, A, A+B parallel						A339-620	2	

¹not available for switch type CA25 ²not available for switch type C315 ³available only up to switch type CA63

Switch Function and Configuration

C, CA, CAD, CL Switches

Function	Escutch. Plate	Type/Handle	Code	Stages	Connection Diagram
		CA4 CA10 CA10B- CA40 CAD11 CAD12 CA25B C315 CL4 CL10			

Coding Switches/Binary Code

0 - 7 360° rotation						A540-600	2	
0 - 7 complement 360° rotation						A541-600	2	
0 - 7 + complement 360° rotation						A542-600	3	
0 - 9						A550-600	2	
0 - 9 complement						A551-600	2	
0 - 9 + complement						A552-600	4	
0 - 11 360° rotation						A543-600	2	
0 - 11 + complement 360° rotation						A545-600	4	

Function	Escutch. Plate	Type/Handle				Code	Stages	Connection Diagram
		CA4 CA4-1 CL4	CAD.. CA10- CA25 CL10	CA10B- CA63	C80- C315			

Multi-step Switches without „OFF“

1 pole 3 Step 2 pole 3 pole 4 pole 5 pole 6 pole						A230-600 A250-600 A270-600 A476-600 A484-600 A489-600	2 3 5 6 8 9	 1 pole 2 pole 3 pole 4- and 5 pole 6 pole
1 pole 4 Step 2 pole 3 pole 4 pole 5 pole 6 pole						A231-600 A251-600 A271-600 A477-600 A485-600 A490-600	2 4 6 8 10 12	 1-3 pole 4-6 pole
1 pole 5 Step 2 pole 3 pole 4 pole						A232-600 A252-600 A272-600 A478-600	3 5 8 10	 1-4 pole
1 pole 6 Step 2 pole 3 pole						A233-600 A253-600 A273-600	3 6 9	 1 and 2 pole 3 pole
1 pole 7 Step 2 pole 3 pole						A234-600 A254-600 A274-600	4 7 11	 1-3 pole
1 pole 8 Step 2 pole 3 pole						A235-600 A255-600 A275-600	4 8 12	 1-3 pole
1 pole 9 Step						A236-600	5	 1 pole
1 pole 10 Step						A237-600	5	 1 pole
1 pole 11 Step						A238-600	6	 1 pole
1 pole 12 Step 1 pole 360° rotation						A239-600 A639-600	6 6	 1 pole

1switch type C315 with handle 2not available for switch type CL4 3not available for switch type CA11B 4not available for switch type CL10

Function	Escutch. Plate	Type/Handle				Code	Stages	Connection Diagram
		CA4 CA4-1 CL4	CAD.. CA10- CA25 CL10	CA10B- CA63	C80- C315			

Multi-step Switches without „OFF“ with electrically isolated contacts

1 pole 3 Step						A730-600	2	 1 pole
2 pole						A750-600	3	 2 pole
1 pole 4 Step						A731-600	2	 1 pole
2 pole						A751-600	4	 2 pole

Multi-step Switches with „OFF“

1 pole 2 Step						A240-600	1	 1-6 pole
2 pole						A260-600	2	
3 pole						A280-600	3	
4 pole						A480-600	4	
5 pole						A486-600	5	
6 pole						A491-600	6	
1 pole						A240-620	1	1-6 pole
2 pole						A260-620	2	
3 pole						A280-620	3	
4 pole						A480-620	4	
5 pole						A486-620	5	
6 pole						A491-620	6	
1 pole 3 Step						A241-600	2	 1 and 2 pole
2 pole						A261-600	3	
3 pole						A281-600	5	
4 pole						A481-600	6	
5 pole						A487-600	8	
1 pole						A241-620	2	3 pole
2 pole						A261-620	3	
3 pole						A281-620	5	
4 pole						A481-620	6	
5 pole						A487-620	8	
1 pole						A241-621	2	4 pole
2 pole						A261-621	3	
								 5 pole

Function	Escutch. Plate	Type/Handle				Code	Stages	Connection Diagram
		CA4 CA4-1 CL4	CAD.. CA10- CA25 CL10	CA10B- CA63	C80- C315			

Multi-step Switches with „OFF“

1 pole 4 Step 2 pole 3 pole 4 pole						A242-600 A262-600 A282-600 A482-600	2 4 6 8	
1 pole 4 Step 2 pole 3 pole 4 pole						A242-620 A262-620 A282-620 A482-620	2 4 6 8	1-4 pole
1 pole 5 Step 2 pole 3 pole						A243-600 A263-600 A283-600	3 5 8	
1 pole 5 Step 2 pole 3 pole						A243-620 A263-620 A283-620	3 5 8	1-3 pole
1 pole 6 Step 2 pole 3 pole						A244-600 A264-600 A284-600	3 6 9	
1 pole 6 Step 2 pole 3 pole						A244-620 A264-620 A284-620	3 6 9	1-3 pole
1 pole 7 Step 2 pole						A245-600 A265-600	4 7	
1 pole 7 Step 2 pole						A245-620 A265-620	4 7	1 pole 2 pole
1 pole 8 Step						A246-600	4	
1 pole 8 Step						A246-620	4	
1 pole 9 Step						A247-600	5	
1 pole 9 Step						A247-620	5	
1 pole 10 Step						A248-600	5	
1 pole 10 Step						A248-620	5	
1 pole 11 Step 1 pole 360° rotation						A249-600 A649-600	6 6	
1 pole 11 Step 1 pole 360° rotation						A249-620 A649-620	6 6	

¹not available for switch type CL4

Switch Function and Configuration

C, CA, CAD, CL Switches

Function	Escutch. Plate	Type/Handle				Code	Stages	Connection Diagram
		CA4 CA4-1 CL4	CA10- CA25	CAD.. CL10	CA10B- CA25B			

Voltmeter Switches without „OFF“

3 phase 3 wire						A023-600	2	
						A023-620	2	
3 phase 3 wire 3 phase to phase and phase to neutral						A025-600	3	
						A025-620	3	

Voltmeter Switches with „OFF“

2 pole 360° rotation						A002-600	1	
3 phase 3 wire						A004-600	2	
						A004-620	2	
						A004-621	2	
						A004-622	2	
						A004-623	2	
						A004-624	2	
						A011-600	2	

Function	Escutch. Plate	Type/Handle				Code	Stages	Connection Diagram
		CA4 CA4-1 CL4	CA10- CA25	CAD.. CL10	CA10B- CA25B			

Voltmeter Switches with „OFF“

3 phase to neutral						A005-600	2	
						A005-620	2	
						A005-621	2	
						A005-622	2	
						A005-623	2	
3 phase to phase and 3 phase to neutral						A007-600	3	
						A007-620	3	
						A007-621	3	
						A007-622	3	
						A007-623	3	
						A007-624	3	
2 separate 3 phase with center „OFF“						A008-600	4	
						A008-620	4	
						A008-621	4	
						A008-622	4	

Switch Function and Configuration

C, CA, CAD, CL Switches

Function	Escutch. Plate	Type/Handle	Code	Stages	Connection Diagram	
	CA4 CA4-1 CL4	CAD.. CA10- CA25 CL10	CA10B- CA50	CA63 C125		

Voltmeter Switches with „OFF“

3 phase and 1 phase to neutral					A010-600	3	
					A010-620	3	
					A010-621	3	
					A010-622	3	

Ammeter Switches

Single pole with one current transformer					A046-600	1	
					A046-620	1	
					A046-621	1	
Single pole with 3 current transformers without „OFF“					A017-600	3	
		CL4	CL10		A017-620	3	
					A059-600	3	
		CL4	CL10		A059-620	3	
Single pole with 3 current transformers with „OFF“ 360° rotation					A048-600	3	
		CL4	CL10		A048-620	3	
					A048-621	3	
		CL4	CA10 CL10		A058-621	3	
					A048-622	3	
		CL4	CL10		A058-622	3	
				A048-623	3		
	CL4	CL10		A058-623	3		

¹available only up to switch type CA25B ²not available for switch types CL4 and CL10

Function	Escutch. Plate	Type/Handle	Code	Stages	Connection Diagram	
		CA4 CA4-1 CL4	CAD.. CA10- CA25 CL10	CA10B- CA50	CA63 C125	

Ammeter Switches

Single pole with 2 current transformers (3 readings)					A021-600	2	 for CL switches:
					A021-620	2	
Single pole with 4 current transformers					A036-600	4	for A036: for A056:
		CL4	CL10		A056-600	4	
					A036-620	4	
		CL4	CL10		A056-620	4	
2 pole 2 current transformers					A037-600	3	
					A037-620	3	
					A037-621	3	
2 pole 3 current transformers					A019-600	5	
					A019-620	5	
					A038-600	5	
					A038-620	5	
					A038-621	5	
					A038-621	5	
2 pole 4 current transformers					A039-600	6	
					A039-620	6	





¹not available for switch types CL4 and CL10 ²available only up to switch type CA25B

Switch Function and Configuration





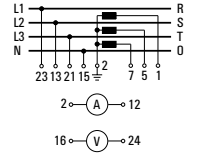
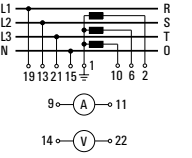
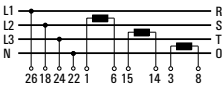
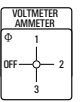
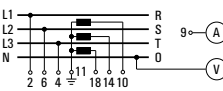
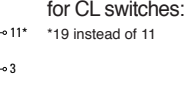
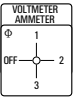

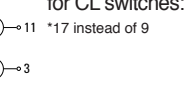



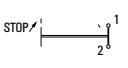

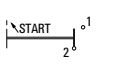
C, CA, CAD, CL Switches

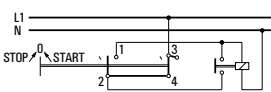
Function	Escutch. Plate	Type/Handle				Code	Stages	Connection Diagram
		CA4 CA4-1 CL4	CAD.. CA10- CA25 CL10	CA10B- CA25B	CA40- CA63			

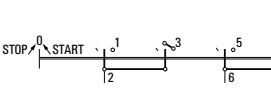
Volt-ammeter Switches

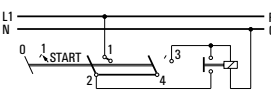
3 phase - phase to phase 3 current	 	¹	¹			A027-600 A057-600	6	for A027:  for A057: 
		CL4	CL10			A028-600	7	
					²			
3 phase voltage 3 phase current 4 wire					²	A033-600	5	 for CL switches: *19 instead of 11 
3 phase voltage 3 phase current 3 wire					²	A035-600	5	 for CL switches: *17 instead of 9 

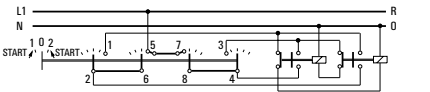
Control Switches

Stop switch					²	A174-600	1	
Start switch					²	A175-600	1	
Stop start switch single pole					²	A176-600	1	
Stop start switch 2 pole						A183-600	2	
Stop start switch with spring return from start to run						A178-600	1	
						A178-620	1	
Stop start switch with spring return to run for 2 units					²	A177-600	2	
					²	A177-620	2	

¹not available for switch types CL4 and CL10 ²available only up to switch type CA50

Function	Escutch. Plate	Type/Handle	Code	Stages	Connection Diagram	
		CA4 CA4-1 CL4	CAD.. CA10- CA25 CL10	CA10B- CA25B	CA40 CA50	

Control Switches

Stop start switch with spring return to run with contactor interlock contactors for 2 units						A182-600	2	
						A182-620	2	
Motor voltage control switch						A150-600	2	

Control Switches with electrically isolated contacts

Stop start switch single pole						A789-600	1	
Stop start switch with spring return to 1						A791-600	1	
Stop start switch with spring return to run for 2 units						A790-600	2	
Contactor control with spring return to „OFF“						A179-600	2	
						A179-620	2	
Circuit breaker control						A537-600	2	

Control and Alarm Switches¹

With slip clutch and without indicator device						A190-600	5 ³	
Without indicator device						A192-600	2	

Function	Escutch. Plate	Type/Handle				Code	Stages	Connection Diagram
		CA4 CA4-1 CL4	CAD.. CA10- CA25 CL10	CA..B CA40- CA63	C80- C315			

Motor Reversing Switches

2 pole						A400-600	2	
						A400-620	2	
						A400-621	2	
3 pole						A401-600	3	
						A401-620	3	
						A401-621	3	
3 pole with spring return to „OFF“						A228-600	3	
						A228-620	3	
3 pole for use with reversing contactors						A402-600	4	

Motor Control Switches

2 speed 2 winding 0-A-BY or Δ						A451-600	3	
						A451-620	3	
3 speed 2 winding 0-AΔ-BY-AYY						A457-600	6	
						A457-620	6	

¹not available for switch type CA25 ²not available for switch types CA40-CA63 ³available only up to switch type CA50

Function	Escutch. Plate	Type/Handle	Code	Stages	Connection Diagram
		CA4 CA4-1 CL4	CAD.. CA10- CA25 CL10	CA10B- CA25B C315 CA40	

Motor Control Switches

2 speed single winding						A440-600	4	
						A440-620	4	
2 speed single winding without „OFF“						A466-600	4	
2 speed single winding with center „OFF“						A441-600	4	
						A441-620	4	
2 speed single winding reversing						A442-600	6	
						A442-620	6	
2 speed single winding for use with contactors						A444-600	5	
						A444-620	5	
2 speed reversing for 2 way operation with slip clutch for „OFF“ load use						A468-600	10 ¹	
						A468-620	10 ¹	

Function	Escutch. Plate	Type/Handle				Code	Stages	Connection Diagram
		CA4 CA4-1 CL4	CAD.. CA10- CA25 CL10	CA..B CA40- CA63	C80- C315			



Star-delta Switches

OFF-star-delta						A410-600	4	
						A410-620	4	
Reversing						A413-600	5	
With auxiliary contact closed in „OFF“ position						A416-600	5	
For use with reversing contactors						A419-600	4	





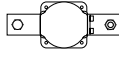





















Start and Run Switches

Split-phase start						A425-600	2	
						A425-620	2	
Split-phase start reversing						A426-600	3	
						A426-620	3	
Split-phase reversing auto cutout of start field winding						A622-600	3	

¹not available for switch types CL4 and CL10 ²not available for switch type CA25

Function/Type	Escutch. Plate	Handle	Code	Stages	Double Latching	Connection Diagram	L350 L630 L1000 L1250		L351 L631 L1001 L1251	
---------------	----------------	--------	------	--------	-----------------	--------------------	--------------------------------	---	--------------------------------	---

ON/OFF Switches with 60° Switching

1 pole 2 pole 3 pole 4 pole			A200-600 A201-600 A202-600 A203-600	1 2 3 4						
1 pole 2 pole 3 pole 4 pole			A200-620 A201-620 A202-620 A203-620	1 2 3 4						
1 pole 2 pole 3 pole 4 pole			A200-600 A201-600 A202-600 A203-600	2 2 4 4						
3 pole with lugs suitable for protective cover			A302-600	3						
1 pole 2 pole 3 pole 4 pole			A200-620 A201-620 A202-620 A203-620	2 2 4 4						A302
1 pole 2 pole 3 pole 4 pole			A200-600 A201-600 A202-600 A203-600	3 3 6 6						
1 pole 2 pole 3 pole 4 pole			A200-600 A201-600 A202-600 A203-600	2 4 6 8	● ●					
1 pole 2 pole 3 pole 4 pole			A200-600 A201-600 A202-600 A203-600	2 4 6 8						
1 pole 2 pole 3 pole 4 pole			A200-600 A201-600 A202-600 A203-600	3 6 9 12	● ● ●					
1 pole 2 pole 3 pole			A200-600 A201-600 A202-600	3 6 9						
1 pole 2 pole 3 pole			A200-600 A201-600 A202-600	4 8 12	● ●					
1 pole 2 pole 3 pole			A200-600 A201-600 A202-600	4 8 12						
1 pole 2 pole			A200-600 A201-600	5 10	●					

Function/Type	Escutch. Plate	Handle	Code	Stages	Double Latching	Connection Diagram	L350 L630 L1000 L1250	L351 L631 L1001 L1251
---------------	----------------	--------	------	--------	-----------------	--------------------	--------------------------------	--------------------------------

ON/OFF Switches with 90° Switching

1 pole 2 pole 3 pole 4 pole	L350/L351 1 pole preclose 60°			A290-600 A291-600 A292-600 A293-600	1 2 3 4			
1 pole 2 pole 3 pole 4 pole	L400 1 pole preclose 60°			A290-600 A291-600 A292-600 A293-600	2 2 4 4			
3 pole	with lugs suitable for protective cover			A307-600	3			
3 pole	360° rotation			A208-600	4			
1 pole 2 pole 3 pole 4 pole	L600 1 pole preclose 60°			A290-600 A291-600 A292-600 A293-600	3 3 6 6			
1 pole 2 pole 3 pole 4 pole	L630/L631 1 pole preclose 60°			A290-600 A291-600 A292-600 A293-600	2 4 6 8			
1 pole 2 pole 3 pole 4 pole	L800 1 pole preclose 60°			A290-600 A291-600 A292-600 A293-600	2 4 6 8	● ● ●		
1 pole 2 pole 3 pole 4 pole	L1000/L1001 1 pole preclose 60°			A290-600 A291-600 A292-600 A293-600	3 6 9 12	● ● ●		
1 pole 2 pole 3 pole	L1200			A290-600 A291-600 A292-600	3 6 9	● ● ●		1-3 pole
1 pole 2 pole 3 pole	L1250/L1251			A290-600 A291-600 A292-600	4 8 12	● ●		1-3 pole

● Additional length for switches size S2 for mounting E/EF = 27 mm
 ● Additional length for switches size S3 for mounting E/EF = 31,5 mm and mounting ER/VE = 20,1 mm

Function/Type	Escutch. Plate	Handle	Code	Stages	Double Latching	Connection Diagram	L350 L630 L1000 L1250	L351 L631 L1001 L1251
---------------	----------------	--------	------	--------	-----------------	--------------------	--------------------------------	--------------------------------

ON/OFF Switches with 90° Switching

1 pole 2 pole 3 pole	L1600			A290-600 A291-600 A292-600	4 8 12	● ● ●		1-3 pole
1 pole 2 pole	L2000			A290-600 A291-600	5 10	● ●		1- and 2 pole

Double-throw Switches without „OFF“ 60° Switching

1 pole 2 pole 3 pole 4 pole	L350/L351			A220-600 A221-600 A222-600 A223-600	2 4 6 8			1-4 pole
1 pole 2 pole 3 pole 4 pole	L400			A220-600 A221-600 A222-600 A223-600	2 4 6 8			1-4 pole
1 pole 2 pole 3 pole 4 pole	L600			A220-600 A221-600 A222-600 A223-600	3 6 9 12	● ●		1-4 pole
1 pole 2 pole 3 pole	L630/L631			A220-600 A221-600 A222-600	4 8 12	●		1-3 pole
1 pole 2 pole 3 pole	L800			A220-600 A221-600 A222-600	4 8 12	●		1-3 pole
1 pole 2 pole	L1000/L1001			A220-600 A221-600	6 12	●		1 and 2 pole
1 pole	L1200			A220-600	6			
1 pole	L1250/L1251			A220-600	8			
1 pole	L1600			A220-600	8			
1 pole	L2000			A220-600	10			

Function/Type	Escutch. Plate	Handle	Code	Stages	Double Latching	Connection Diagram	L350 L630 L1000 L1250	L351 L631 L1001 L1251
---------------	----------------	--------	------	--------	-----------------	--------------------	--------------------------------	--------------------------------

Double-throw Switches with Center „OFF“

1 pole 2 pole 3 pole 4 pole	L350/L351			A210-600 A211-600 A212-600 A213-600	2 4 6 8			1-4 pole
1 pole 2 pole 3 pole 4 pole	L400			A210-600 A211-600 A212-600 A213-600	2 4 6 8			1-4 pole
1 pole 2 pole 3 pole 4 pole	L600			A210-600 A211-600 A212-600 A213-600	3 6 9 12	● ●		1-4 pole
1 pole 2 pole 3 pole	L630/L631			A210-600 A211-600 A212-600	4 8 12	●		1-3 pole
1 pole 2 pole 3 pole	L800			A210-600 A211-600 A212-600	4 8 12	●		1-3 pole
1 pole 2 pole	L1000/L1001			A210-600 A211-600	6 12	●		1 and 2 pole
1 pole	L1200			A210-600	6			
1 pole	L1250/L1251			A210-600	8			
1 pole	L1600			A210-600	8			
1 pole	L2000			A210-600	10			

Multi-step Switches single pole without „OFF“

3 Step	L350/L351			A230-600	4			
3 Step	L400			A230-600	4			
4 Step	L350/L351			A231-600	4			
4 Step	L400			A231-600	4			
5 Step	L350/L351			A232-600	6			





- Additional length for switches size S2 for mounting E/EF = 27 mm
- Additional length for switches size S3 for mounting E/EF = 31,5 mm and mounting ER/VE = 20,1 mm

Function/Type	Escutch. Plate	Handle	Code	Stages	Double Latching	Connection Diagram	L350 L630 L1000 L1250	L351 L631 L1001 L1251
---------------	----------------	--------	------	--------	-----------------	--------------------	--------------------------------	--------------------------------



Multi-step Switches single pole without „OFF“

5 Step	L400			A232-600	6			
6 Step	L350/L351			A233-600	6			
6 Step	L400			A233-600	6			
7 Step	L350/L351			A234-600	8			
7 Step	L400			A234-600	8			
8 Step	L350/L351			A235-600	8			
8 Step	L400			A235-600	8			
9 Step	L350/L351			A236-600	10			
9 Step	L400			A236-600	10			
10 Step	L350/L351			A237-600	10			
10 Step	L400			A237-600	10			
11 Step	L350/L351			A238-600	12			
11 Step	L400			A238-600	12			
12 Step	L350/L351			A239-600	12			
12 Step	L400			A239-600	12			









Two Hole Panel Mounting or Mosaic Mounting	Terminals rotated 90°	Code	CA4 CA4-1 CL4
--	-----------------------	-------------	---------------------

	<p>Panel mounting</p> <p>Two hole panel mounting</p>	●	E E-V	● ●
	<p>Panel mounting with shaft seal Protection IP 66</p> <p>Two hole panel mounting</p>	●	EF EF-V	● ●
	<p>Panel mounting with round shaft for combining with commercial radio knobs</p> <p>Two hole panel mounting Shaft diam. 6 mm/.24 inch</p> <p>Two hole panel mounting Shaft diam. 6.35 mm/.25 inch</p>		E9 E91	● ●
	<p>Mosaic mounting</p> <p>For Siemens-Mosaic 30 mm grid depth</p> <p>For Subklew-, Kreutzenbeck-, Symo-Mosaic 28 mm 25 mm 25 mm grid depth</p> <p>For Mauell-Mosaic 30 mm grid depth</p>		E92 E93 E94	● ● ●





Two or Four Hole Panel Mounting	Terminals rotated 90°	Code	CAD.. CA10- CA25 CL10	CA10B- CA63	C80- C125 L350- L1251 Size S2	C315 L400- L2000 Size S3
--	-----------------------	-------------	--------------------------------	----------------	---	-----------------------------------

 <p>Panel mounting</p> <p>Four hole panel mounting</p> <p>Four hole panel mounting Protection IP 66</p> <p>Two hole panel mounting Protection IP 65</p>	<p>●</p> <p>●</p> <p>●</p>	<p>E E-V</p> <p>EF EF-V</p> <p>E22 E22-V</p>	<p>●</p> <p>●</p> <p>●</p>	<p>●</p> <p>●</p> <p>●</p>	<p>●</p> <p>●</p> <p>●</p>	<p>●</p> <p>●</p> <p>●</p>
 <p>Panel mounting using larger escutcheon plate and handle and with heavy duty latching</p> <p>Four hole panel mounting</p> <p>Four hole panel mounting Protection IP 66</p>		<p>EG</p> <p>EGF</p>	<p>●</p> <p>●</p>	<p>CA40- CA63</p> <p>CA40- CA63</p>	<p>C80- C125</p> <p>C80- C125</p>	
 <p>Panel and base mounting</p> <p>Four hole mounting</p> <p>Four hole mounting Protection IP 66</p>		<p>ER</p> <p>ERF</p>	<p>●</p> <p>●</p>	<p>●</p> <p>●</p>	<p>●</p> <p>●</p>	<p>●</p> <p>●</p>



Two or Four Hole Panel Mounting	Code	CAD.. CA10- CA25 CL10	CA10B CA11B CA20B CA25B	CA40 CA50 CA63
--	-------------	--------------------------------	----------------------------------	----------------------

	<p>Panel mounting with heavy duty latching and metal shaft</p> <p>Four screw panel mounting Mounting plate, escutcheon plate and handle of size S0</p>	KN2	●		
	<p>Four screw panel mounting Mounting plate, escutcheon plate and handle of size S1</p>	KN1	●	●	●
	<p>Four screw panel mounting Mounting plate, escutcheon plate and handle of size S1 and 6 mm square metal shaft</p>	KD1	●	●	●
	<p>Panel mounting with protective cover</p>				
	<p>Four screw panel mounting Protection front IP 40 rear IP 30 for CA and CAD IP 42 for CA40-CA63</p>	EC	CAD.. CA10- CA25	●	●
	<p>Four screw panel mounting with additional shaft seal Protection front IP 65 rear IP 30 for CA and CAD IP 42 for CA40-CA63</p>	ED	CAD.. CA10- CA25	●	●
	<p>Four screw panel mounting Protection front IP 40 rear IP 42</p>	EC1		●	
	<p>Four screw panel mounting with additional shaft seal Protection front IP 65 rear IP 42</p>	ED1		●	
	<p>Two screw panel mounting Protection front IP 65 rear IP 42</p>	ED22	CAD.. CA10- CA25		





Single Hole Mounting	Terminals rotated 90°	Code	CA4 CA4-1 CL4	CAD.. CA10- CA25 CL10
----------------------	-----------------------	------	---------------------	--------------------------------

		Code	mm	mm
 <p>With locking nut and shaft seal, protection IP 66</p> <p>Without escutcheon plate</p>	●	FS1 FS1-V FT1 FT1-V FT3 FT3-V	16/22 16/22	22 22 22/30 22/30
 <p>With square escutcheon plate</p>	●	FS2 FS2-V FT2 FT2-V FT4 FT4-V	16/22 16/22	22 22 22/30 22/30
<p>With size S1 square escutcheon plate and heavy duty latching</p>	●	FH3 FH3-V		22 22
 <p>With rectangular escutcheon plate</p>	●	FS4 FS4-V FT6 FT6-V	16/22 16/22	22 22
<p>With size S1 rectangular escutcheon plate and heavy duty latching</p>  <p>Mounting key for locking nut</p>	●	FH4 FH4-V		22 22
		S00 T170 09		



Base Mounting	Terminals rotated 90°	Code	CAD.. CA10- CA25 CL10	CA10B- CA63	C80- L2000
---------------	-----------------------	------	--------------------------------	----------------	---------------

<p>Base mounting</p>  <p>Base mounting - four hole</p> <p>For four hole base mounting and with integrated simplified door clutch, protection IP 65</p>	<p>●</p> <p>●</p>	<p>VE VE-V</p> <p>VF VF-V</p>	<p>CAD.. CA10- CA25</p> <p>CAD.. CA10- CA25</p>	<p>●</p> <p>●</p>	<p>●</p>
<p>For two hole base mounting</p>  <p>For two hole base mounting and with integrated simplified door clutch, protection IP 65</p>	<p>●</p> <p>●</p>	<p>VE22 VE22V</p> <p>VF22 VF22V</p>	<p>● CAD.. CA10- CA25</p> <p>● CAD.. CA10- CA25</p>		
<p>Snap-on base mounting for track EN 50022</p> 		<p>VE1</p>	<p>●</p>	<p>●</p>	

Base Mounting	Code	CA4 CA4-1	CAD.. CA10- CA25 CL10
---------------	------	--------------	--------------------------------

Base mounting				
	<p>Snap-on base mounting for track EN 50022 with escutcheon plate for 45 mm standard knock-out.</p>	VE2		●
	<p>Snap-on base mounting for track EN 50022. Both the escutcheon plate for 45 mm standard knock-out and the handle are adjustable in height.</p>	VE21	●	CAD.. CA10- CA25
	<p>Snap-on base mounting for track EN 50022 with circular escutcheon plate for 46 mm knock-out.</p>	VE3		●
	<p>Base mounting - four hole - for circular escutcheon plate with 46 mm knock-out.</p>	VE4		CAD.. CA10- CA25

<p>Mounting Plates for Plaster Depth Boxes acc. to DIN 49070 and ÖNORM E6508</p>	<p>Code</p>	<p>CAD.. CA10- CA25</p>
--	-------------	---------------------------------

	<p>Plaster depth trim</p>	<p>UE1</p>	<p>●</p>
	<p>With light</p> <p>With facility for light addition</p>	<p>UE2</p> <p>UE3</p>	<p>●</p> <p>●</p>
	<p>Plaster depth trim</p> <p>With light</p> <p>With facility for light addition</p>	<p>UE4</p> <p>UE5</p> <p>UE6</p>	<p>●</p> <p>●</p> <p>●</p>

Escutcheon Plates

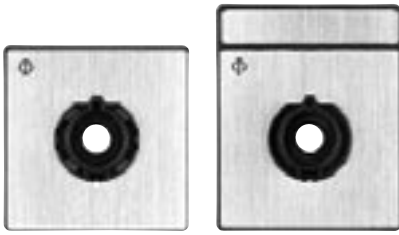

Square and rectangular escutcheon plates are available for each size of switch. The escutcheon plate consists of a frame and a faceplate having the switch positions which is then embossed with hot-foil backing. The escutcheon plate frame is an essential part of the switch and serves as a bearing surface for the handle. If the switch is to be mounted without an escutcheon plate we would recommend for size S1, S2 and S3 the handle bearing plate T100-04.

Standard Letterings Available

(Over 500 standard letterings, special letterings upon request.)

30° switching

F022	F141	F158	F703	F023	F137	F142	F159	F701	F704	F152	F709	F026	F035	F153	F169	F024	F143	
F160	F221	F222	F224	F025	F034	F036	F037	F038	F039	F139	F144	F147	F149	F150	F151	F219	F258	
F259	F273	F280	F329	F384	F708	F053	F161	F297	F298	F306	F307	F001	F040	F052	F229	F355	F018	
F019	F029	F030	F154	F155	F165	F166	F183	F184	F301	F302	F321	F332	F333	F334	F335	F335	F374	F711
F712	F002	F021	F033	F041	F055	F305	F319	F054	F003	F042	F138	F255	F299	F308	F353	F350	F351	
F004	F014	F017	F020	F027	F028	F031	F032	F043	F049	F135	F156	F157	F162	F167	F168	F187	F189	
F303	F304	F336	F337	F347	F348	F710	F713	F714	F734	F005	F044	F136	F140	F702	F006	F010	F045	
F015	F050	F007	F011	F046	F008	F012	F047	F016	F051	F009	F013	F048	F748					

45° switching

F747	F295	F742	F743	F215	F216	F738	F744	F746	F792	F793	F107	F109	F114	F115	F212	F213	F214
F217	F267	F289	F330	F375	F376	F383	F408	F409	F410	F411	F412	F413	F426	F427	F430	F729	F752
F775	F776	F777	F778	F779	F780	F781	F796	F797	F798	F105	F108	F112	F113	F117	F118	F293	F429
F739	F741	F419	F789	F790	F791	F794	F795	F110	F106	F116	F294	F317	F414	F415	F416	F417	F418
F782	F783	F784	F785	F786	F787	F788	F799	F111	F210	F211	F284	F285	F296	F322	F727	F740	

Escutcheon Plates

60° switching

F070	F087	F088	F089	F133	F197	F198	F232	F243	F247	F263	F268	F310	F311	F323	F328	F352	F367
F379	F380	F470	F754	F072	F163	F164	F192	F193	F196	F230	F231	F234	F244	F257	F262	F264	F282
F288	F291	F313	F382	F441	F705	F721	F722	F750	F757	F758	F075	F076	F098	F220	F223	F356	F357
F377	F723	F071	F073	F080	F081	F085	F086	F090	F091	F092	F093	F094	F104	F194	F235	F237	F239
F240	F241	F249	F260	F269	F274	F281	F290	F292	F312	F314	F315	F316	F324	F331	F344	F354	F358
F359	F364	F370	F371	F373	F381	F385	F442	F444	F469	F732	F735	F759	F077	F100	F101	F102	F309
F342	F343	F361	F362	F363	F365	F366	F078	F191	F325	F326	F720	F074	F082	F096	F097	F195	F724
F256	F079	F083	F084	F095	F099	F185	F190	F199	F233	F236	F238	F242	F283	F725	F730	F731	F736
F737																	

90° switching

F056	F063	F068	F134	F201	F251	F252	F346	F456	F058	F065	F069	F177	F178	F182	F208	F253	F254
F340	F360	F378	F458	F443	F700	F743	F057	F061	F064	F067	F171	F181	F205	F207	F209	F320	F349
F437	F445	F715	F719	F059	F060	F062	F066	F170	F172	F173	F174	F175	F176	F179	F180	F186	F188
F202	F204	F206	F250	F265	F266	F286	F318	F327	F338	F339	F425	F716	F717	F718	F726	F733	F751
F755	F756																

Miscellaneous

F119	F130	F122	F126	F125	F129	F225	F248	F246	F261	F341	F345	F287	F123	F127	F145	F146	F148						
F706	F707	F245	F120	F124	F128	F131	F121	F132	F749									F990	F991	F801	F802	F803	F804
F805	F806	F807	F808	F809	F810	F811	F812	F813	F814	F815	F816	F817	F818	F819	F820	F821	F822						
															2	<p>¹INTERRUPTEUR PRINCIPAL, OUVERTURE EN POSITION 0 ²INTERRUPTORE GENERALE, APRIRE SOLO CON MANIGLIA SU 0 ³INTERRUPTOR PRINCIPAL, ABRIR ARMARIO SOLO EN POS. "0"</p>							

Handles

Type	Color	Code	Size S00 S0 S1 S2 S3
------	-------	------	-------------------------

Type	Color	Code	Size S00 S0 S1 S2 S3
------	-------	------	-------------------------

<p>R-Handle</p> 	<p>black red white electro-gray</p>	<p>G001 G002 G003 G007</p>	<p>— ● ● ● ● — ● ● ● ● — ● ● ● ● — ● ● ● ●</p>
---	---	--	--

<p>I-Handle</p>  <p>S00 S0-S3</p>	<p>black red white electro-gray</p>	<p>G251 G252 G253 G257</p>	<p>● ● ● ● ● ● ● ● ● ● ● ● ● ● ● ● ● ● ● ●</p>
--	---	--	--

<p>F-Handle</p> 	<p>black red white electro-gray</p>	<p>G221 G222 G223 G227</p>	<p>● ● ● ● — ● ● ● ● — ● ● ● ● — ● ● ● ● —</p>
--	---	--	--

<p>B-Handle</p> 	<p>black red white electro-gray</p>	<p>G521 G522 G523 G527</p>	<p>— ● ● — — — ● ● — — — ● ● — — — ● ● — —</p>
---	---	--	--

<p>S-Handle</p>  <p>S0 S1</p>	<p>black red white electro-gray</p>	<p>G301 G302 G303 G307</p>	<p>— ● ● — — — ● ● — — — ● ● — — — ● ● — —</p>
--	---	--	--

<p>L-Handle</p> 	<p>black red white electro-gray</p>	<p>G501 G502 G503 G507</p>	<p>— — ● — — — — ● — — — — ● — — — — ● — —</p>
---	---	--	--

















<p>P-Handle</p>  <p>S0 S1-S3</p>	<p>black red white electro-gray</p>	<p>G211 G212 G213 G217</p>	<p>— ● ● ● ● — ● ● ● ● — ● ● ● ● — ● ● ● ●</p>
--	---	--	--

<p>K-Handle</p> 	<p>black red white electro-gray</p>	<p>G411 G412 G413 G417</p>	<p>— — ● ● ● — — ● ● ● — — ● ● ● — — ● ● ●</p>
---	---	--	--

<p>Handwheel</p> 	<p>black</p>	<p>G971</p>	<p>— — — — ●</p>
--	--------------	-------------	------------------

<p>O-Handle</p> 	<p>black red white electro-gray</p>	<p>G321 G322 G323 G327</p>	<p>— — ● — — — — ● — — — — ● — — — — ● — —</p>
---	---	--	--

International Standards and Approvals

Country	Authority	Mark or Standard	CAD11/12		CA10	CA10B	CA40		L350/1	L1250/1	L400	L1200
			CL4 CL10	CA4 CA4-1	CA11 CA20	CA11B CA20B	CA25 CA25B	CA50 CA63	C80 C125	L630/1 L1000/1	C315 C316	L600 L800
USA	Underwriters Laboratories Inc.	 ¹							●	●	●	●
		 ² ³	●	●	●	●	+				●	+
Canada	UL investigated acc. to CSA	 ⁶	+	●	●	●	+		●	●	●	●
		 ¹							●	●	●	●
		 ² ³	●	●	●	●	+					●
Switzerland	Schweizerischer Elektrotechnischer Verein	 ¹	+	+	+	+	+	+	+	+	+	+
Denmark	Danmarks Elektriske Materielkontrol	 ¹	+	+	+	+	+	+	+	+	+	+
Norway	Norges Elektriske Materielkontrol	 ¹	+	+	+	+	+	+	+	+	+	+
Sweden	Svenska Elektriska Materielkontrollanstalten	 ¹	+	+	+	+	+	+	+	+	+	+
Finland	Sähkötar-kastuskeskus	 ¹	+	+	+	+	+	+	+	+	+	+
Austria	Österreichischer Verband für Elektrotechnik	 ¹	+	+	+	+	+	+	+	+	+	+
Federal Republic of Germany	Verband Deutscher Elektrotechniker	VDE 0660 ⁴	+	+	+	+	+	+	+	+	+	+
Great Britain	British Standards Institution	BS EN 60947 ⁴	+	+	+	+	+	+	+	+	+	+
International Electrical Commission (IEC) Recommendation		IEC 60947 ⁵	+	+	+	+	+	+	+	+	+	+
China	China Quality Certification Centre	 ⁷		●	●	●						
Russian Federation	GOST	 ⁷	●	●	●	●		●	+	+	+	+
Russian Federation	Russian Maritime Register of Shipping	 ⁷	●	●	●	●						
Germanischer Lloyd		 ⁷	+	+	+	+	+	+	+	+	+	+
Lloyds Register of Shipping		 ⁷	+	+	+	+	+	+	+	+	+	+

● Switch approved + Switch conforms to requirements + No approval required

¹Approved under the "Component Program" (UL-Recognized Industrial Component). File No. E35541, Category Control No. NLRV2 (U.S.) resp. NLRV8 (Canada).

²Approved under the "Listing Program". File No. E35541, Category Control No. NLRV (U.S.) resp. NLRV7 (Canada).

³Switch types CAD11/CAD12 approved under the "Listing Program". File No. E60262, Category Control No. NRNT (U.S.) resp. NRNT7 (Canada).

⁴It is not required for Industrial Switchgear to bear a symbol but must conform to requirements. By stating the specific standard no. on the product the manufacturer declares that all requirements of the product standard are met.

⁵IEC does not operate an approval scheme.

⁶File No. 13002, Class No. 3211-05 resp. 4652-04.

⁷If this approval is required, please request when ordering.

Selection Data	CA4	CA10	CA11	CA20	CA25														
	CA4-1	CL4	CA10B	CL10	CA11B	CA20B	CA25B	CA40	CA50	CA63	C80	C125	C315/C316						

Rated Insulation Voltage U_i	IEC 60947-3, EN 60947-3 ¹ VDE 0660 part 107 ¹	V	440	440	690	690	690	690	690	690	690	690	690	690	690	690	690	690	1000		
	SEV ⁴	V	380	380	660	690	660	660	690	690	690	690	660	660	660						
	UL/Canada	V	300	300	300	600	600	600	300	600	600	600	600	600	600	600	600	600	600	600	
	CEE/NEMKO	V	400/380	–	380	–	400	400	–	–	–	–	400	–	–						
	min. voltage	V																		on request	
Rated Impulse Withstand Voltage U_{imp}		kV	4	4	6	6	6	6	6	6	6	6	6	6	6	6	6	6	6/8		
Rated Thermal Current I_U/I_{th}	IEC 60947-3, EN 60947-3 VDE 0660 part 107	A	10	10	20	20	20	25	32	40	50	63	115	150	315						
	SEV ⁴	A	10	10	16	16	16	25	32	40	50	63	100	160	315						
	380 V	A	–	–	12	12	12	25	32	40	50	63	–	–	315						
	660 V	A	–	–	12	12	12	25	32	40	50	63	–	–	315						
UL/Canada	A	10	10	20	20	20	30	30	45	55	65	100	150	240							
Rated Operational Current I_e	AC-21A Switching of resistive loads, including moderate overloads	IEC 60947-3, EN 60947-3 VDE 0660 part 107	A	10	10	20	20	20	25	32	40	50	63	100	150	315					
	AC-1 Resistive or low inductive loads	SEV ⁴	A	10	10	16	16	16	25	32	40	50	63	100	160	315					
		380 V	A	–	–	12	12	12	20	32	40	50	63	–	–	315					
		660 V	A	–	–	12	12	12	20	32	40	50	63	–	–	315					
	AC-22A Switching of combined resistive or low inductive loads including moderate overloads	IEC 60947-3, EN 60947-3 VDE 0660 220 V-500 V part 107 660 V-690 V	A	10	10	20	20	20	25	32	40	50	63	100	150	315					
			A	–	–	20	20	20	25	32	40	50	63	100	125	125					
	AC-15 Switching of control devices, contactors, valves etc.	IEC 60947-3, EN 60947-3 VDE 0660 220 V-240 V part 107 380 V-440 V	A	2,5	2,5	5	5	5	8	12	14	16	16	–	–	–					
			A	1,5	1,5	4	4	4	5	6	6	7	7	–	–	–					
	Pilot Duty	UL/Canada ⁴ Heavy		A300	C300	A300	A600	A600	A600	A300	A600	A600	A600	–	–	A600					
	Ampere Rating Resistive or low inductive loads	UL/Canada ⁴	A	10	10	20	20	20	30	30	45	55	60	100	150	240					
Resistive load/motor load	CEE	A	4/2	–	10/6	–	10/6	16/10	–	–	–	–	63/10	–	–						
	NEMKO	A	6/4 ²	–	10/6	–	–	20/10	–	–	–	–	–	–	–						
Breaking capacity	220 V-240 V	A	50	50	150	150	150	200	280	290	330	440	860	1100	2000						
	380 V-440 V	A	50	50	150	150	150	200	250	290	330	440	860	1100	2000						
	660 V-690 V	A	–	–	80	80	80	125	150	170	200	260	400	490	340						
Power loss per contact at I_U		W	0,4/0,9	0,4	0,9	1	0,9	0,9	0,7	1	1,8	2,8	5,8	3,8	17						
Resistance to vibration																			on request		
Resistance to shock																			min. 5 g, 30 ms		
Short Circuit Protection	Max. fuse size (gL/gG-characteristic)	A	10	10	25	25	25	35	35	50	63	63	125	200	315						
	Rated short-time withstand current (1s-current)	A	60	90	140	140	140	280	480	950	950	950	1300	2000	4200						
DC Switching Capacity⁶	No. of series contacts	1	2	3	4	5	6	8	Rated Operational Current I_e												
		Voltage V							CA4	CA10	CA11	CA20	CA25						C315 ³		
	Resistive loads $T \leq 1$ ms	24	48	70	95	120	145	190	CA4-1	CL4	CA10B	CL10	CA11B	CA20B	CA25B	C26S	C32S	C42S	C80	C125	C316 ³
		48	95	140	190	240	290	350	10	10	20	20	20	25	32	–	50	–	115	–	315
		60	120	180	240	300	360	450	6	6	12	12	12	20	25	32	40	63	100	150	250
		110	220	330	440	550	660	–	2,5	2,5	4,5	4,5	4,5	7,5	10	23	27	30	–	–	–
		220	440	660	–	–	–	–	0,7	0,7	1	1	1	1,5	2	6,5	–	–	–	–	–
	440	660	–	–	–	–	–	0,3	0,3	0,4	0,4	0,4	0,5	0,6	1,2	–	–	–	–	–	
	Inductive loads $T = 50$ ms	24	48	70	95	120	145	190	0,2	0,2	0,27	0,27	0,27	0,3	0,3	0,4	–	–	–	–	–
		30	60	90	120	150	180	240	6	6	12	12	12	20	25	32	40	63	100	150	250
48		95	140	190	240	290	350	3	3	5	5	5	9	12	25	30	55	33	50	70	
60		120	180	240	300	360	450	1	1	2	2	2	3	3	16	20	–	–	–	–	
110		220	330	440	550	660	–	0,7	0,7	1	1	1	1,5	1,5	11	15	–	–	–	–	
							0,3	0,3	0,4	0,4	0,4	0,5	0,5	3,2	3,5	–	–	–	–		
Ambient Temperature of Stages^{5,7}	open at 100 % I_U/I_{th}		55 °C during 24 hours with peaks up to 60 °C																		
	enclosed at 100 % I_{the}		35 °C during 24 hours with peaks up to 40 °C																		

¹Valid for lines with grounded common neutral termination, overvoltage category III, pollution degree 3. Values for other supply systems on request. ²Valid for CA4 only. ³DC switching capacity applies to ON/OFF switches. Switching capacity for other configurations on request. ⁴International Standards and Approvals, refer to page 39. ⁵For electromagnetic optional extras see additional data in Catalog 101. ⁶Values for switches with spring return on request. ⁷Storage temperature: -40 °C to 85 °C (in case of temperature below -5 °C no shock load permissible).

Selection Data	CA4	CA10	CA11	CA20	CA25						C315
	CA4-1 CL4	CA10B CL10	CA11B	CA20B	CA25B	CA40	CA50	CA63	C80	C125	C316

Rated Utilization Category	IEC 60947-3, EN 60947-3 VDE 0660 part 107																			
AC-2 Slip ring motor starting, reversing and plugging, star-delta starting CA4-CA50	3 phase 220 V-240 V	kW	2,5	2,5	4	4	4	5,5	7,5	10	11	18,5	30	37	55					
	3 pole 380 V-440 V		4,5	4,5	7,5	7,5	7,5	11	15	18,5	22	30	45	55	90					
	500 V		-	-	10	10	10	15	18,5	22	30	40	55	75	110					
	660 V-690 V		-	-	10	10	10	13	15	22	30	37	55	55	55					
AC-3 Direct-on-line starting, star-delta starting CA63-C315	3 phase 220 V-240 V	kW	1,5	1,5	3	3	3	4	5,5	7,5	11	11	15	22	37					
	3 pole 380 V-440 V		2,2	2,2	5,5	5,5	5,5	7,5	11	15	18,5	18,5	30	37	55					
	500 V		-	-	5,5	5,5	5,5	7,5	11	15	18,5	18,5	30	37	55					
	660 V-690 V		-	-	5,5	5,5	5,5	7,5	11	15	18,5	22	30	30	37					
AC-4 Direct-on-line starting, reversing, plugging and inching	1 phase 110 V-120 V	kW	0,3	0,3	0,6	0,6	0,6	1,5	2,2	2,5	3	3	3,7	5,5	11					
	2 pole 220 V-240 V		0,55	0,55	2,2	2,2	2,2	3	4	5,5	6	6	7,5	11	22					
	380 V-440 V		0,75	0,75	3	3	3	3,7	5,5	7,5	11	11	13	18,5	30					
	660 V-690 V		-	-	1,5	1,5	1,5	3	5,5	6	7	7,5	11	15	25					
	3 phase 220 V-240 V	kW	0,37	0,37	0,55	0,55	0,55	1,5	2,5	3,7	4	5,5	6	10	15					
	3 pole 380 V-440 V		0,55	0,55	1,5	1,5	1,5	3	5,5	6	7	7,5	11	15	25					
	500 V		-	-	1,5	1,5	1,5	3	5,5	6	7	7,5	11	15	25					
	660 V-690 V		-	-	1,5	1,5	1,5	3	5,5	6	7,5	9	11	15	22					
1 phase 110 V-120 V	kW	0,15	0,15	0,3	0,3	0,3	0,45	0,75	1,1	1,2	1,2	1,5	2,2	4						
2 pole 220 V-240 V		0,25	0,25	0,75	0,75	0,75	1,1	1,5	2,2	2,4	2,4	3	4	7,5						
380 V-440 V		0,5	0,5	1,5	1,5	1,5	2,2	3	3,7	4	4	5,5	7,5	11						
660 V-690 V		-	-	1,5	1,5	1,5	2,2	3	3,7	4	4	5,5	7,5	11						
AC-23A Frequent switching of motors or other high inductive loads	3 phase 220 V-240 V	kW	1,8	1,8	3,7	3,7	3,7	5,5	7,5	7,5	11	15	30	37	75					
	3 pole 380 V-440 V		3	3	7,5	7,5	7,5	11	15	18,5	22	30	45	75	132					
	500 V		-	-	7,5	7,5	7,5	11	15	18,5	22	30	55	90	132					
	660 V-690 V		-	-	7,5	7,5	7,5	11	15	18,5	22	30	45	55	37					
1 phase 110 V-120 V	kW	0,37	0,37	0,75	0,75	0,75	1,5	2,2	2,2	2,5	4	5,5	11	18,5						
2 pole 220 V-240 V		0,75	0,75	2,5	2,5	2,5	3	4	4	5,5	10	15	22	37						
380 V-440 V		1,1	1,1	3,7	3,7	3,7	5,5	7,5	7,5	11	18,5	22	37	55						
660 V-690 V		-	-	3,7	3,7	3,7	5,5	7,5	7,5	11	18,5	22	37	55						
Ratings	Standard motor load DOL-Rating (similar AC-3)	UL/Canada	110 V-120 V	3 phase	220 V-240 V	HP	0,75	0,75	1,5	1,5	1,5	3	5	7,5	7,5	7,5	10	15	30	
							3 pole 440 V-480 V	1	1	3	3	3	7,5	10	15	15	15	20	25	75
							550 V-600 V	-	-	-	5	5	10	-	25	25	30	30	40	75
							550 V-600 V	-	-	-	5	5	10	-	25	30	30	40	50	60
	1 phase 110 V-120 V	2 pole	HP	0,33	0,33	0,5	0,5	0,5	1,5	2	3	3	3	5	7,5	15				
				220 V-240 V	0,75	0,75	1	1	1	3	5	7,5	7,5	7,5	10	15	40			
				277 V	0,75	0,75	2	2	2	3	5	7,5	7,5	10	10	15	40			
				440 V-480 V	-	-	-	2	2	5	-	15	15	15	20	25	50			
	Heavy motor load Reversing-Rating (similar AC-4)	UL/Canada	110 V-120 V	3 phase	220 V-240 V	HP	-	-	0,5	-	0,5	1	2	-	-	-	7,5	10	15	
							3 pole 440 V-600 V	-	-	1	-	1	2	3	-	-	-	15	20	30
							440 V-600 V	-	-	-	-	3	5	-	-	-	-	25	30	40
							550 V-600 V	-	-	0,17	-	0,17	0,33	1,5	-	-	-	3	5	7,5
1 phase 110 V-120 V	2 pole	HP	-	-	0,5	-	0,5	0,75	3	-	-	-	7,5	10	15					
			220 V-240 V	-	-	0,6	-	0,6	1	3	-	-	-	7,5	10	15				
			277 V	-	-	0,6	-	0,6	1	3	-	-	-	7,5	10	15				
			440 V-480 V	-	-	0,6	-	0,6	1	3	-	-	-	7,5	10	15				
Max. Permissible Wire Gage - Use copper wire only Single-core or stranded wire	mm ²	AWG	2x	1x ²	2x	1x ²	2x	2x	2x											
			1,5	0,5-1,5	2,5	0,5-2,5	2,5	4	6	16	16	16	35	70	185 ¹					
			14	20-16	12	20-14	12	10	8	6	6	6	2	2/0	MCM					
															350					
Flexible wire (sleeving in accordance with DIN 46228) Flexible AWG wires (without sleeve)	mm ²	AWG	2x	1x ²	2x	1x ²	2x	2x	2x											
			1,5	0,5-1,5	2,5	0,5-2,5	2,5	4	4	10	10	10	25	50	150 ¹					
			(-)	(-)	(2,5)	(-)	(2,5)	(2,5)	(4)	10	10	10	(25)	(50)						
Connecting wire - outside diameter	mm	-	1,5-2,8	-	1,5-3,6	-	-	-	-	-	-	-	-	-						
Connecting wire - plug-in depth	mm	-	8,5	-	11,5	-	-	-	-	-	-	-	-	-						
Permissible connecting ambiente temperature range	°C	-	5-40	-	5-40	-	-	-	-	-	-	-	-	-						

¹Cable lug must accept M12 screw. ²The insulation material of the conductor has to be PVC (typical wire codes are H05V-K0,5 ... H07V-K1,5 or H05V-U0,5 ... H07V-U1,5 etc.). Other materials on request. Connected conductors, which have to be disconnected and re-connected again must be cut in order to ensure a proper electrical connection and to prevent a complete cut-off of the wire insulation.

Selection Data	L350	L630			L1000			L1250		
	L351	L400	L600	L631	L800	L1001	L1200	L1251	L1600	L2000

Rated Insulation Voltage U_i	IEC 60947-3, EN 60947-3 ¹ VDE 0660 part 107 ¹ UL/Canada ²	V	690	690	690	690	690	690	690	690	690	690			
		V	600	600	600	600	600	600	600	600	600	600			
	min. voltage	V	on request												
Rated Impulse Withstand Voltage U_{imp}		kV	6	6	6	6	6	6	6	6	6	6			
Rated Thermal Current I_U/I_{th}	IEC 60947-3, EN 60947-3 VDE 0660 part 107														
	Ambient temp. +35 °C during 24 hours with peaks up to +40 °C	A	350	500	800	630	1100	1000	1450	1250	1900	2400			
	Ambient temp. +55 °C during 24 hours with peaks up to +60 °C	A	350	500	750	600	950	920	1300	1100	1700	2000			
	UL/Canada ²	A	350	400	630	630	800	1000	1200	1250	1600	2000			
Rated Operational Current I_e	AC-20A No-load operation	IEC 60947-3, EN 60947-3 VDE 0660 part 107	690 V	A	350	500	800	630	1100	1000	1450	1250	1900	2400	
		Occasional switching under load $\cos \varphi$ 0,8 (AC-20B)	3 phase, 3 pole	220 V-440 V	A	350	500	800	500	1000	630	1200	630	1200	1200
			and	500 V	A	350	450	500	450	630	500	800	500	800	800
		1 phase, 2 pole	660 V-690 V	A	315	350	400	360	400	400	400	400	400	400	
	AC-21B Switching of resistive loads, including moderate overloads	3 phase, 3 pole	220 V-440 V	A	250	450	500	350	630	400	800	400	800	800	
		and	500 V	A	250	400	450	315	500	350	630	350	630	630	
		1 phase, 2 pole	660 V-690 V	A	200	300	350	250	350	300	350	300	350	350	
	Interrupting Rating	UL/Canada ² CSA	600 V	A	200	300	300	200	300	200	300	200	200	200	
			600 V	A	200	200	200	200	200	200	200	200	200	200	
	Rated Utilization Category	IEC 60947-3, EN 60947-3 VDE 0660 part 107	AC-23B Occasional switching of motors or other high inductive loads	3 phase	220 V-240 V	kW	45	75	75	45	75	45	75	45	75
3 pole				380 V-440 V	kW	90	132	132	90	132	90	132	90	132	132
				500 V	kW	110	132	132	110	132	110	132	110	132	132
				660 V-690 V	kW	55	55	65	65	65	65	65	65	65	65
Short Circuit Protection		Max. fuse size Rated short-time withstand current	(aR-characteristic) (1s-current)	A	400	500	800	630	1100	1000	2x800	1250	2x1000	2x1250	
				A	on request										
Terminals		for connection screw	length	mm	Cable lug or copper bus										
					M12	M12	M16	M16	M16	M16	M16	M16	M16	2xM16	4xM16
					20	30	40	30	40	40	40	40	50	50	50
Ambient Temperature of Stages^{3,4}					55 °C during 24 hours with peaks up to 60 °C, permissible load see Rated Thermal Current.										

¹Valid for lines with grounded common neutral termination, overvoltage category III, pollution degree 3. Values for other supply systems on request.
²International Standards and Approvals, refer to page 39. ³For electromagnetic optional extras see additional data in Catalog 101. ⁴Storage temperature: -40 °C to 85 °C (in case of temperature below -5 °C no shock load permissible).

Two or Four Hole Panel Mounting

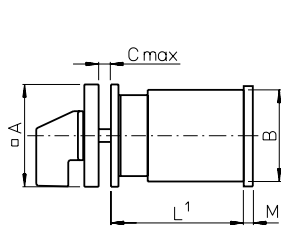

E
for CA4, CA4-1
E-V
for CL4

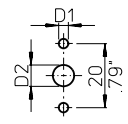

E-V
for CA4, CA4-1
E
for CL4

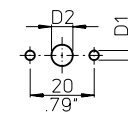

E
E-V
ER

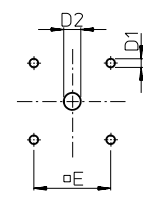

	CA4		CA10 CA11 CAD11		CA10B CA11B CA20B		CA40 ³ CA50 ³ CA63 ³		C80		C125		L switches		
	CA4-1	CL4	CAD12	CL10	CA20	CA25 ³	CA20B	CA25B	CA63 ³	C80	C125	Size S2	Size S3	Size S2	Size S3
A	30 1.18	30 1.18	48 1.89	48 1.89	48 1.89	48 (64) 1.89 (2.52)	64 2.52	64 2.52	64 (88) 2.52 (3.46)	88 3.46	88 3.46	88 3.46	88 3.46	88 3.46	130 5.12
B	29,5 1.16	38x46 1.50x1.81	43 1.69	50x56 1.97x2.20	45 1.77	46 1.81	56 2.20	56 2.20	55,5x64 2.19x2.52	84 3.30	88 3.46	88 3.46	88 3.46	88 3.46	126 4.96
C	4 .16	4 .16	4 .16	4 .16	4 .16	4 .16	4 .16	4 .16	4 .16	5,5 .22	5,5 .22	5,5 .22	5,5 .22	5,5 .22	7 .28
D1	3,2 .13	3,2 .13	5 .20	5 .20	5 .20	5 .20	5 .20	5 .20	5 (6) .20 (.24)	6 .24	6 .24	6 .24	6 .24	6 .24	7 .28
D2	8-11 .31-.43	8-11 .31-.43	8-15 .31-.59	8-15 .31-.59	8-15 .31-.59	8-15 .31-.59	10-15 .39-.59	10-15 .39-.59	10-15 .39-.59	13-17 .51-.67	13-17 .51-.67	13-17 .51-.67	13-17 .51-.67	13-17 .51-.67	15,5-20 .61-.79
E	-	-	36 1.42	36 1.42	36 1.42	36 (48) 1.42 (1.89)	48 1.89	48 1.89	48 (68) 1.89 (2.68)	68 2.68	68 2.68	68 2.68	68 2.68	68 2.68	104 4.09
M²	-	-	4,5 .18	-	4,5 .18	5,5 .22	5 .20	5,5 .22	7,6 .30	9,4 .37	9,4 .37	27,5 1.08	11,9 .47	27,5 1.08	11,9 .47

²M, additional length for mounting ER only
³Dimensions in () for ER mounting plate only

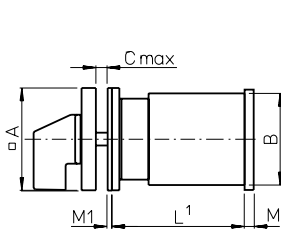

EF
for CA4, CA4-1
EF-V
for CL4

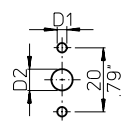

EF-V
for CA4, CA4-1
EF
for CL4

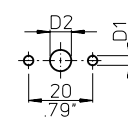

EF
EF-V
ERF

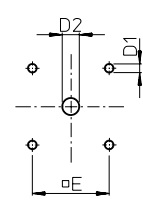

	CA4		CA10 CA11 CAD11		CA10B CA11B CA20B		CA40 ³ CA50 ³ CA63 ³		C80		C125		L switches		
	CA4-1	CL4	CAD12	CL10	CA20	CA25 ³	CA20B	CA25B	CA63 ³	C80	C125	Size S2	Size S3	Size S2	Size S3
A	30 1.18	30 1.18	48 1.89	48 1.89	48 1.89	48 (64) 1.89 (2.52)	64 2.52	64 2.52	64 (88) 2.52 (3.46)	88 3.46	88 3.46	88 3.46	88 3.46	88 3.46	130 5.12
B	29,5 1.16	38x46 1.50x1.81	43 1.69	50x56 1.97x2.20	45 1.77	46 1.81	56 2.20	56 2.20	55,5x64 2.19x2.52	84 3.30	88 3.46	88 3.46	88 3.46	88 3.46	126 4.96
C	4 .16	4 .16	4 .16	4 .16	4 .16	4 .16	4 .16	4 .16	4 .16	5,5 .22	5,5 .22	5,5 .22	5,5 .22	5,5 .22	7 .28
D1	3,2 .13	3,2 .13	5 .20	5 .20	5 .20	5 .20	5 .20	5 .20	5 (6) .20 (.24)	6 .24	6 .24	6 .24	6 .24	6 .24	7 .28
D2	8-11 .31-.43	8-11 .31-.43	15-19 .59-.75	15-19 .59-.75	15-19 .59-.75	15-19 .59-.75	19-22 .75-.87	19-22 .75-.87	19-22 .75-.87	26-30 1.02-1.18	26-30 1.02-1.18	26-30 1.02-1.18	26-30 1.02-1.18	26-30 1.02-1.18	22-25 .87-.98
E	-	-	36 1.42	36 1.42	36 1.42	36 (48) 1.42 (1.89)	48 1.89	48 1.89	48 (68) 1.89 (2.68)	68 2.68	68 2.68	68 2.68	68 2.68	68 2.68	104 4.09
M²	-	-	4,5 .18	-	4,5 .18	5,5 .22	5 .20	5,5 .22	7,6 .30	9,4 .37	9,4 .37	27,5 1.08	11,9 .47	27,5 1.08	11,9 .47
M1	1 .04	1 .04	-	-	-	-	-	-	-	-	-	-	-	-	-

²M, additional length for mounting ERF only
³Dimensions in () for ERF mounting plate only

Two or Four Hole Panel Mounting

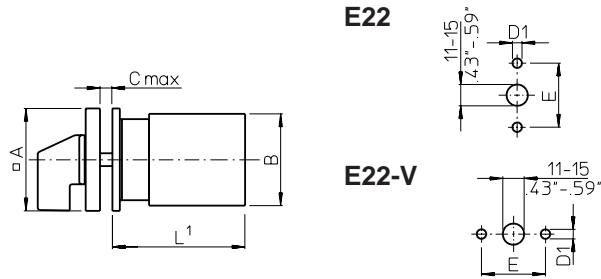

	CA10	CA11	CAD11	CAD12	CL10	CA20	CA25
A	48 1.89	48 1.89	48 1.89	48 1.89	48 1.89	48 1.89	48 1.89
B	43 1.69	50x56 1.97x2.20	45 1.77	46 1.81			
C	4 .16	4 .16	4 .16	4 .16			
D1	5 .20	5 .20	5 .20	5 .20			
E	30 1.17	30 1.17	30 1.17	30 1.17			

**EG
EGF**

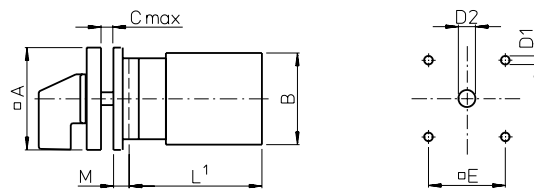

	CA10	CA11	CAD11	CAD12	CL10	CA20	CA25	CA40	CA50	CA63	C80	C125
												L switches
												Size S2
A	64 2.52	64 2.52	64 2.52	64 2.52	64 2.52	64 2.52	64 2.52	88 3.46	130 5.12	130 5.12	130 5.12	130 5.12
B	43 1.69	50x56 1.97x2.20	45 1.77	46 1.81	45 1.77	46 1.81	46 1.81	55,5x64 2.19x2.52	84 3.30	84 3.30	84 3.30	88 3.46
C	4 .16	4 .16	4 .16	4 .16	4 .16	4 .16	4 .16	5,5 .22	7 .28	7 .28	7 .28	7 .28
D1	5 .20	5 .20	5 .20	5 .20	5 .20	5 .20	5 .20	6 .24	7 .28	7 .28	7 .28	7 .28
EG D2	10-15 .39-.59	10-15 .39-.59	10-15 .39-.59	10-15 .39-.59	10-15 .39-.59	10-15 .39-.59	10-15 .39-.59	13-17 .51-.67	15,5-20 .61-.79	15,5-20 .61-.79	15,5-20 .61-.79	15,5-20 .61-.79
EGF D2	19-22 .75-.87	19-22 .75-.87	19-22 .75-.87	19-22 .75-.87	19-22 .75-.87	19-22 .75-.87	19-22 .75-.87	26-30 1.02-1.18	22-25 .87-.98	22-25 .87-.98	22-25 .87-.98	22-25 .87-.98
E	48 1.89	48 1.89	48 1.89	48 1.89	48 1.89	48 1.89	48 1.89	68 2.68	104 4.09	104 4.09	104 4.09	104 4.09
M	6,7 .26	6,7 .26	6,7 .26	6,7 .26	6,7 .26	6,7 .26	6,7 .26	0,5 .02	2 .08	2 .08	2 .08	2 .08

¹see page 51

Four Hole Panel Mounting or Mosaic Mounting

E9
E91

E92

E93
E94

		CA4	CL4
B	CA4-1	29,5	38x46
		1.16	1.50x1.81

CA4	E9	E91	E92	E93	E94
CA4-1	6	6,35	-	-	-
D	.24	.25	-	-	-
F	.12	.12,8	-	-	-
	.47	.50	-	-	-
G	15,4	17,4	32,5	28,5	32,5
	.61	.69	1.28	1.12	1.28
K	4,7	5,5	-	-	-
	.19	.22	-	-	-
M	-	-	-	4	-
	-	-	-	.16	-

KN1
KD1
KN2

	CA10				CA10B		CA40
	CAD12	CL10	CA20	CA25	CA11B	CA25B	CA50
A	48	48	48	48	64	64	64
	1.89	1.89	1.89	1.89	2.52	2.52	2.52
B	43	50x56	45	46	56	56	55,5x64
	1.69	1.97x2.20	1.77	1.81	2.20	2.20	2.19x2.52
C	4	4	4	4	4	4	4
	.16	.16	.16	.16	.16	.16	.16
D1	5	5	5	5	5	5	5
	.20	.20	.20	.20	.20	.20	.20
D2	8-15	8-15	8-15	8-15	10-15	10-15	10-15
	.31-.59	.31-.59	.31-.59	.31-.59	.39-.59	.39-.59	.39-.59
E	36	36	36	36	48	48	48
	1.42	1.42	1.42	1.42	1.89	1.89	1.89
M	5,2	5,2	5,2	5,2	7	7	7
	.20	.20	.20	.20	.28	.28	.28

Two or Four Hole Panel Mounting

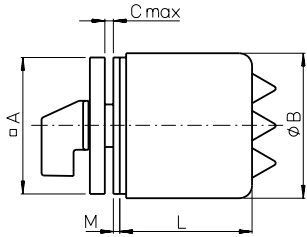

ED22

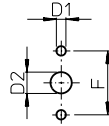

**EC
ED
EC1
ED1**

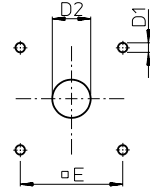

		CA10 CAD11 CAD12		CA11		CA20		CA25		CA10B		CA11B		CA20B CA25B		CA40 CA50 CA63		
		EC		EC		EC		EC		EC		EC1		EC1		EC		
		ED	ED22	ED	ED22	ED	ED22	ED	ED22	ED	ED1	ED	ED1	ED	ED1	ED	ED	
A		48 1.89	48 1.89	48 1.89	48 1.89	64 2.52	48 1.89	64 2.52	48 1.89	64 2.52	64 2.52	64 2.52	64 2.52	64 2.52	64 2.52	64 2.52	88 3.46	
	B	50 1.97	74 2.91	50 1.97	74 2.91	68 2.68	74 2.91	68 2.68	74 2.91	88 3.46	74 2.91	88 3.46	74 2.91	88 3.46	74 2.91	88 3.46	74 2.91	108 4.25
EC/EC1 ED/ED1/ ED22	C	4 .16	-	4 .16	-	4 .16	-	4 .16	-	4 .16	4 .16	4 .16	4 .16	4 .16	4 .16	4 .16	5,5 .22	
	C	2 .08	4 .16	2 .08	4 .16	2 .08	4 .16	2 .08	4 .16	2 .08	4 .16	4 .16	4 .16	4 .16	4 .16	4 .16	7,5 .30	
EC/EC1 ED/ED1/ ED22	D1	5 .20	5 .20	5 .20	5 .20	5 .20	5 .20	5 .20	5 .20	5 .20	5 .20	5 .20	5 .20	5 .20	5 .20	5 .20	6 .24	
	D2	8-15 .31-.59	-	8-15 .31-.59	-	8-15 .31-.59	-	8-15 .31-.59	-	10-15 .39-.59	10-15 .39-.59	10-15 .39-.59	10-15 .39-.59	10-15 .39-.59	10-15 .39-.59	10-15 .39-.59	13-15 .51-.59	
EC/EC1 ED/ED1/ ED22	D2	18-22 .71-.87	11-15 .43-.59	18-22 .71-.87	11-15 .43-.59	18-22 .71-.87	11-15 .43-.59	18-22 .71-.87	11-15 .43-.59	18-22 .71-.87	11-15 .43-.59	22-25 .87-.98	19-22 .75-.87	22-25 .87-.98	19-22 .75-.87	22-25 .87-.98	28-33 1.10-1.30	
	E	36 1.42	-	36 1.42	-	48 1.89	-	48 1.89	-	48 1.89	48 1.89	48 1.89	48 1.89	48 1.89	48 1.89	48 1.89	68 2.68	
ED/ED22	F	-	30 1.17	-	30 1.17	-	30 1.17	-	30 1.17	-	-	-	-	-	-	-	-	
	M	2 .08	1,5 .06	2 .08	1,5 .06	2 .08	1,5 .06	2 .08	1,5 .06	2 .08	-	2 .08	-	2 .08	-	2 .08	2,2 .09	
Stages L	1	53,5 2.10	74,3 2.93	53,5 2.10	74,3 2.93	-	74,3 2.93	-	74,3 2.93	-	73,7 2.90	-	73,7 2.90	-	73,7 2.90	-	101 3.98	
	2	53,5 2.10	74,3 2.93	53,5 2.10	74,3 2.93	-	74,3 2.93	-	74,3 2.93	-	73,7 2.90	-	73,7 2.90	-	73,7 2.90	-	101 3.98	
	3	67,5 2.66	74,3 2.93	67,5 2.66	94,3 3.71	-	74,3 2.93	-	94,3 3.71	-	73,7 2.90	-	93,7 3.69	-	93,7 3.69	-	101 3.98	
	4	67,5 2.66	74,3 2.93	81,5 3.21	94,3 3.71	-	94,3 3.71	-	94,3 3.71	-	93,7 3.69	-	93,7 3.69	-	93,7 3.69	-	101 3.98	
	5	81,5 3.21	94,3 3.71	-	-	103 4.06	-	103 4.06	-	-	93,7 3.69	103 4.06	-	103 4.06	-	103 4.06	-	139 5.47
	6	81,5 3.21	94,3 3.71	-	-	-	-	-	-	103 4.06	-	127 5	-	127 5	-	127 5	-	139 5.47
	7	-	-	-	-	-	-	-	-	127 5	-	139,5 5.47	-	139,5 5.47	-	139,5 5.47	-	139 5.47
	8	-	-	-	-	-	-	-	-	127 5	-	152 5.98	-	152 5.98	-	152 5.98	-	177 6.97
	9	-	-	-	-	-	-	-	-	139,5 5.47	-	164,5 6.48	-	164,5 6.48	-	164,5 6.48	-	177 6.97
	10	-	-	-	-	-	-	-	-	152 5.98	-	177 6.97	-	177 6.97	-	177 6.97	-	177 6.97
	11	-	-	-	-	-	-	-	-	152 5.98	-	-	-	-	-	-	-	215 8.46
	12	-	-	-	-	-	-	-	-	164,5 6.48	-	-	-	-	-	-	-	215 8.46

Single Hole Mounting or Base Mounting

FS1...
FT1...
FT3...

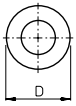

FS1...
FS2...
FS4...

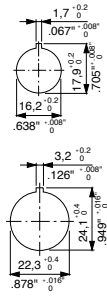

FH3...
FS2...
FT2...
FT4...



FH3...
FH4...
FT1...
FT2...
FT6...

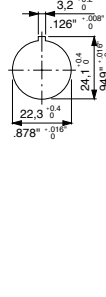

FH4...
FS4...
FT6...

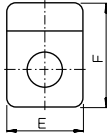

FT3...
FT4...

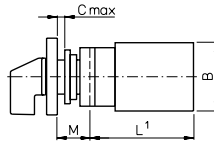
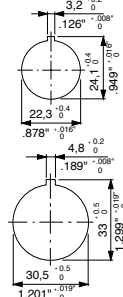

	CA4		CA10		CA20	
	CA4-1	CL4	CAD12	CL10	CA20	CA25
A/E	30 1.18	30 1.18	48 1.89	48 1.89	48 1.89	48 1.89
FH3...	-	-	64 2.52	64 2.52	64 2.52	64 2.52
B	28 1.10	38x46 1.50x1.81	43 1.69	50x56 1.97x2.20	45 1.77	46 1.81
C	5 .20	5 .20	6 .24	6 .24	6 .24	6 .24
D	29.5 1.16	29.5 1.16	39 1.54	39 1.54	39 1.54	39 1.54
F	39 1.54	39 1.54	59 2.32	59 2.32	59 2.32	59 2.32
FH4...	-	-	78.5 3.09	78.5 3.09	78.5 3.09	78.5 3.09
M	12.5 .49	12.5 .49	18.2 .72	18.2 .72	18.2 .72	18.2 .72
FH3...	-	-	25.2 .99	25.2 .99	25.2 .99	25.2 .99

VE
VE-V

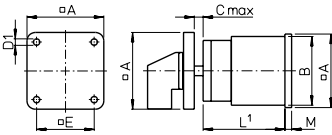

VF
VF-V

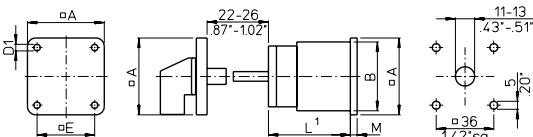

VE22
VE22V

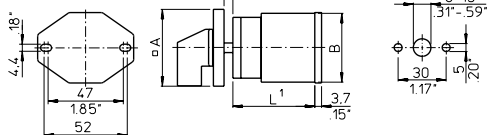

VF22
VF22V

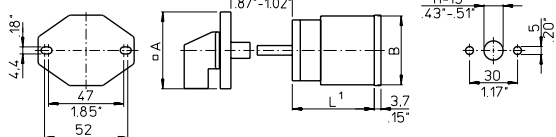

	CA10				CA10B		CA40 ²			C315		
	CA11	CAD12	CL10	CA20	CA11B	CA20B	CA50 ²	CA63 ²	C80	C125	L switches Size S2	L switches Size S3
A	48 1.89	48 1.89	48 1.89	48 1.89	64 2.52	64 2.52	64 2.52	88 3.46	88 3.46	88 3.46	88 3.46	128 5.04
B	43 1.69	43 1.69	45 1.77	46 1.81	56 2.20	56 2.20	55,5x64 2.19x2.52	84 3.30	84 3.30	88 3.46	88 3.46	126 4.96
C	10.5 .41	10.5 .41	10.5 .41	10.5 .41	13.5 .53	13.5 .53	13.5 .53	16 .63	16 .63	16 .63	16 .63	19.3 .76
D1	4.1 .16	-	4.1 .16	4.1 .16	4.1 .16	4.1 .16	5.4 .21	5.4 .21	5.4 .21	5.4 .21	5.4 .21	7 .28
D2	5 .20	-	5 .20	5 .20	5 .20	5 .20	5 .20	6 .24	6 .24	6 .24	6 .24	7 .28
D3	8-15 .31-.59	-	8-15 .31-.59	8-15 .31-.59	10-15 .39-.59	10-15 .39-.59	10-15 .39-.59	13-17 .51-.67	13-17 .51-.67	13-17 .51-.67	13-17 .51-.67	15,5-20 .61-.79
E	36 1.42	-	36 1.42	36 1.42	48 1.89	48 1.89	48 1.89	68 2.68	68 2.68	68 2.68	68 2.68	104 4.09
M	2.2 .09	-	2.2 .09	3.2 .13	2.5 .10	2.5 .10	5.1 .21	8.9 .35	8.9 .35	8.9 .35	27 1.06	11.4 .45

²Dimensions in () for revertive mounting plate

Base Mounting

VE1

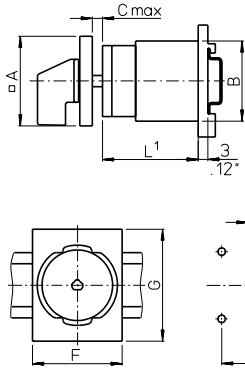

VE2

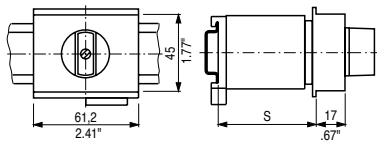

VE3

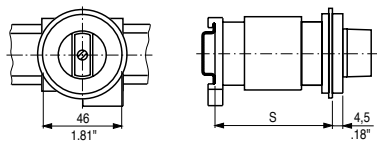

VE4

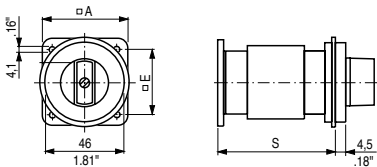

	CA10	CA11	CAD11	CAD12	CL10	CA20	CA25	CA10B	CA11B	CA20B	CA25B	CA40	CA50	CA63
A	48	48	48	48	48	48	48	64	64	64	64	64	64	64
	1.89	1.89	1.89	1.89	1.89	1.89	1.89	2.52	2.52	2.52	2.52	2.52	2.52	2.52
B	43	50x56	45	46	46	46	46	56	56	56	56	55,5x64	55,5x64	55,5x64
	1.69	1.97x2.20	1.77	1.81	1.81	1.81	1.81	2.20	2.20	2.20	2.20	2.19x2.52	2.19x2.52	2.19x2.52
C	10,5	10,5	10,5	10,5	10,5	10,5	10,5	13,5	13,5	13,5	13,5	13,5	13,5	13,5
	.41	.41	.41	.41	.41	.41	.41	.53	.53	.53	.53	.53	.53	.53
D1	5	5	5	5	5	5	5	5	5	5	5	5	5	5
	.20	.20	.20	.20	.20	.20	.20	.20	.20	.20	.20	.20	.20	.20
D2	8-15	8-15	8-15	8-15	8-15	8-15	8-15	10-15	10-15	10-15	10-15	10-15	10-15	10-15
	.31-.59	.31-.59	.31-.59	.31-.59	.31-.59	.31-.59	.31-.59	.39-.59	.39-.59	.39-.59	.39-.59	.39-.59	.39-.59	.39-.59
E	36	36	36	36	36	36	36	48	48	48	48	48	48	48
	1.42	1.42	1.42	1.42	1.42	1.42	1.42	1.89	1.89	1.89	1.89	1.89	1.89	1.89
F	48	48	48	48	48	48	48	70	70	70	70	70	70	70
	1.89	1.89	1.89	1.89	1.89	1.89	1.89	2.76	2.76	2.76	2.76	2.76	2.76	2.76
G	60	60	60	60	60	60	60	60	60	60	60	60	60	60
	2.36	2.36	2.36	2.36	2.36	2.36	2.36	2.36	2.36	2.36	2.36	2.36	2.36	2.36

VE21 (for CA4 and CA4-1)

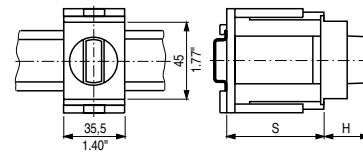

VE21 (for CA10-CA25)

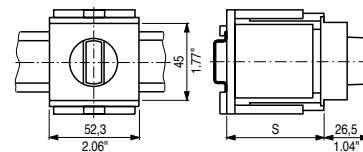

	VE2			VE3		VE4			VE21				
	CA10	CA11		CA10	CA11	CA10	CA11		CA4	CA10	CA11	CA20	CA25
	CAD11	CA20		CAD11	CA25	CAD11	CA11		CA4-1	CAD11	CA11	CA20	CA25
	CAD12	CL10	CA25	CAD12	CL10	CAD12	CA20	CA25	No. of stages				
	Max. no. of stages			Max. no. of stages		Max. no. of stages							
S = 46 1.81	3	1	-	1	1	1	2	-	1/2	1/2	1/2	1/2	1
S = 50 1.97	3	1	1	2	1	2	2	1	3	3	-	-	2
S = 61 2.40	4	2	2	3	2	3	3	2	4	-	-	-	-
S = 67 2.64	5	2	2	3	2	3	3	2	-	-	3	3	-
S = 69 2.70	5	3 ²	3	4	3	4	4	3	-	-	-	-	3
									5	-	-	-	-
									-	4/5	-	-	-
									-	-	4	-	-
									6	-	-	4	-
									-	6	-	-	4

¹see page 51 ²not available for switch type CA20

Wall Mounting, Escutcheon Plates and Additional Length

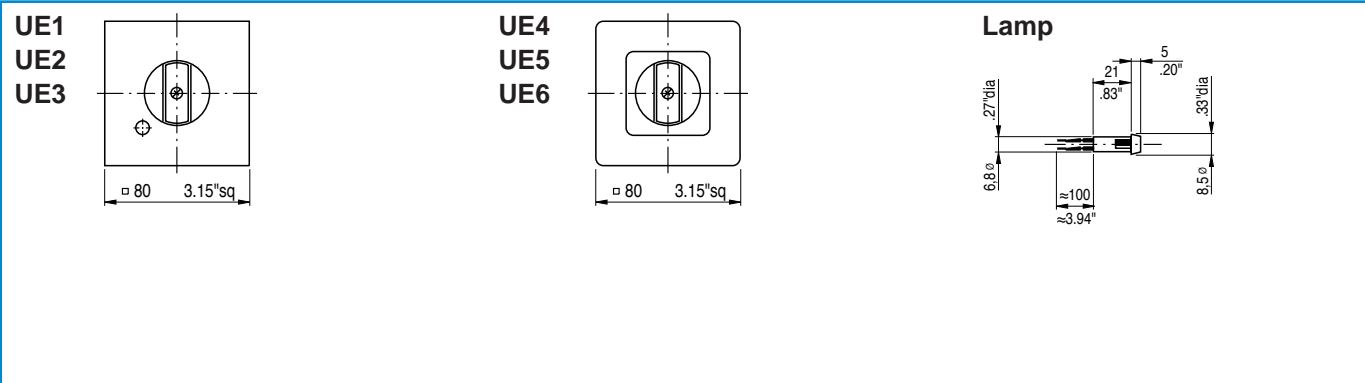

Escutcheon plates for mounting E, EF, ER, ERF, EG, EGF, KN1, KD1, KN2, EC, EC1, ED, ED1, VE, VE1, VF

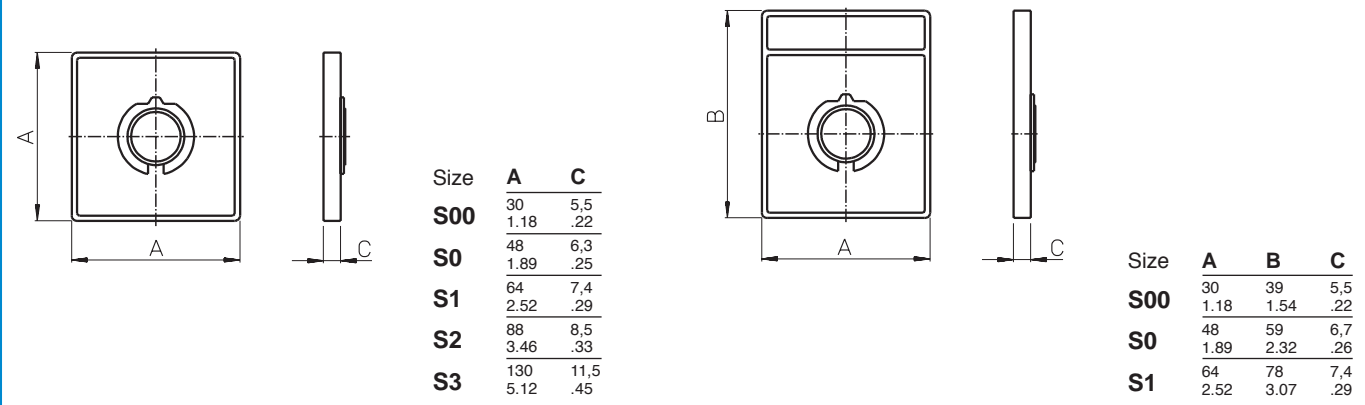

Additional length for amendment (page 4)

	CA10	CA20	CA40
	CA11	CA25	CA50
	CAD11	CA25	CA63
	CAD12	CA25	CA63
Latching mechanism size S1	5,4 .21	5,4 .21	in preparation
Latching mechanism size S2	-	-	in preparation
Snap action	14,3 .56	14,3 .56	in preparation

Quick connects for switches CA4-4



Additional Length

Terminal lugs for switches C315, C316 and L switches

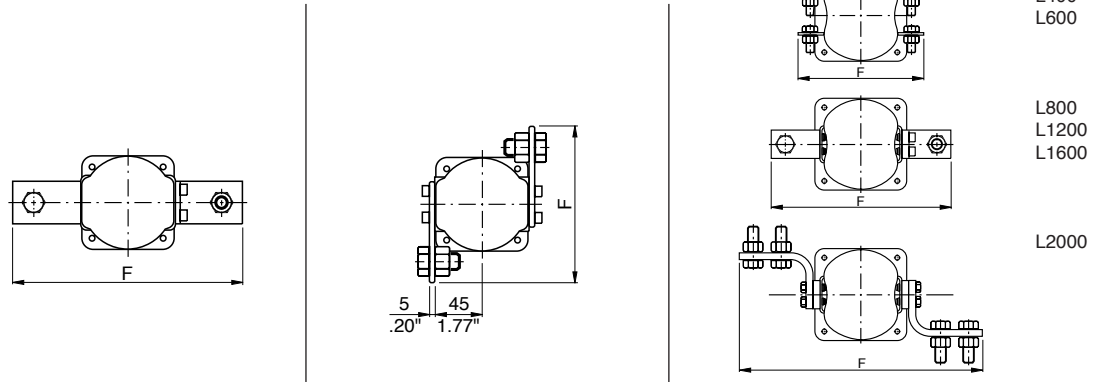

F	L350	L630	L1000	L1250	L351	L631	L1001	L1251	C315		L400	L600	L800	L1200	L1600	L2000
	190	220	230	240	138	148	148	148	C316	L400	L600	L800	L1200	L1600	L2000	
	7.48	8.66	9.06	9.45	5.43	5.83	5.83	5.83	5.91	7.09	8.19	10.08	10.08	12.83	12.83	

Length L

Stages	CA4		CA10 CAD11		CA11	CA20	CA25	CA10B	CA11B	CA20B	CA25B	CA40 CA50		C125 L switches Size S2	C315 L switches Size S3
	CA4-1	CL4	CAD12	CL10								CA63	C80		
1	30	34	33,5	37,2	36,7	37,7	39	38,9	42,1	43,1	44,4	42,5	61,5	67,5	78,6
	1.18	1.34	1.32	1.46	1.44	1.48	1.51	1.53	1.66	1.70	1.75	1.67	2.42	2.66	3.09
2	38	46	43	49,9	49,4	50,4	53	48,4	54,8	55,8	58,4	55,2	88,0	100	117,2
	1.50	1.81	1.69	1.96	1.94	1.98	2.09	1.91	2.16	2.20	2.30	2.17	3.46	3.94	4.61
3	46	58	52,5	62,6	62,1	63,1	67	57,9	67,5	68,5	72,4	67,9	114,5	132,5	155,8
	1.81	2.28	2.07	2.46	2.44	2.48	2.64	2.28	2.66	2.70	2.85	2.67	4.51	5.22	6.13
4	54	70	62	75,3	74,8	75,8	81	67,4	80,2	81,2	86,4	80,6	141	165	194,4
	2.13	2.76	2.44	2.96	2.94	2.98	3.19	2.65	3.16	3.20	3.40	3.17	5.55	6.50	7.65
5	62	82	71,5	88	87,5	88,5	95	76,9	92,9	93,9	100,4	93,3	167,5	197,5	233
	2.44	3.23	2.81	3.46	3.44	3.48	3.74	3.03	3.66	3.70	3.95	3.67	6.59	7.78	9.17
6	70	94	81	100,7	100,2	101,2	109	86,4	105,6	106,6	114,4	106	194	230	271,6
	2.76	3.70	3.19	3.96	3.94	3.98	4.29	3.40	4.16	4.20	4.50	4.17	7.64	9.06	10.69
7	78	106	90,5	113,4	112,9	113,9	123	95,9	118,3	119,3	128,4	118,7	220,5	262,5	310,2
	3.07	4.17	3.56	4.46	4.44	4.48	4.84	3.78	4.66	4.70	5.05	4.67	8.68	10.33	12.21
8	86	118	100	126,1	125,6	126,6	137	105,4	131	132	142,4	131,4	247	295	348,8
	3.39	4.65	3.94	4.96	4.94	4.98	5.39	4.15	5.16	5.20	5.60	5.17	9.72	11.61	13.73
9	94	-	109,5	138,8	138,3	139,3	151	114,9	143,7	144,7	156,4	144,1	273,5	327,5	387,4
	3.70	-	4.31	5.46	5.44	5.48	5.94	4.52	5.66	5.70	6.15	5.67	10.77	12.89	15.25
10	-	-	119	151,5	151	152	165	124,4	156,4	157,4	170,4	156,8	300	360	426
	-	-	4.68	5.96	5.94	5.98	6.50	4.90	6.16	6.20	6.70	6.17	11.81	14.17	16.77
11	-	-	128,5	-	163,7	164,7	179	133,9	169,1	170,1	184,4	169,5	326,5	392,5	464,6
	-	-	5.06	-	6.44	6.48	7.05	5.27	6.66	6.70	7.25	6.67	12.85	15.45	18.29
12	-	-	138	-	176,4	177,4	193	143,4	181,8	182,8	198,4	182,2	353	425	503,2
	-	-	5.43	-	6.94	6.98	7.60	5.65	7.16	7.20	7.80	7.17	13.90	16.73	19.81

The Range of “Blue Line” Switchgear

Technical literature covering the following products is available on request.

	Catalog Number
Main Switches and Main Switches with Emergency Function 16 A-315 A Maintenance Switches 20 A-315 A Switch Disconnectors 20 A-315 A According to IEC 60947-3, EN 60947-3, VDE 0660 part 107, IEC 60204, EN 60204 and VDE 0113	500
CL Switches 10 A-20 A C, CA and CAD Switches 10 A-315 A and L Switches 350 A-2400 A C, CA and CAD switches are designed for universal application. They are recommended for instrument, isolator, double-throw and motor control. L switches are designed for load and off-load applications. They are used to switch resistive or low inductive loads.	100
Optional Extras and Enclosures The complete product line, a large number of optional extras is available, including door interlocks, push-pull devices, cylinder and padlock attachments, control and indicator devices, AC motor drives, as well as enclosures, both insulated and metal.	101
A and AD Switches 6 A-25 A A and AD switches have 4 contacts in each switching stage. These switches provide an extensive range of switch functions and require a minimum mounting depth. Up to 36 switching positions are possible, with availability of 48 contacts per 12 stage switch column.	110
CG, CH and CHR Switches 10 A-25 A Ultra compact CG, CH and CHR switches are ideally suited for control and instrumentation applications. Switch terminals are “finger-proof” and conveniently accessible for wiring and are delivered open. All CG4 switches offer specially designed gold plated contacts or H-bridges with “cross-wire” contact systems, which facilitates their use in electronic circuitry and chemically aggressive environments.	120
DH, DHR, DK and DKR Switches 6 A-16 A DH, DHR, DK and DKR switches incorporate unique corrosion resistant contacts that permit operation on system voltage as low as 1 V. They have fully enclosed and protected contacts which can be operated either by rotary and/or lateral handle movement. D switches are used in calibration and semiconductor circuits. They are also used for relay and contactor control.	130
X Switches 200 A-630 A X switches can be applied for load, tap and gang switching duties. They incorporate 6 contacts in each switching stage. Their compact design provides a minimum length dimension for mounting purposes.	140
KG Switches 20 A-315 A and KH and KHR Switches 16 A-80 A KG, KH and KHR switches are excellent circuit interruptors. They have high through fault and fault making capacities and are especially designed for use as isolators and safety switches for machine tools, distribution panels and switchboards. KG ON/OFF switches offer unusually high dimensioned air and creepage distances between terminals which are designed for time saving “straight-line” wiring. ON/OFF switches are available with up to 8 poles and double-throw switches are available with up to 4 poles.	150
Contactors 16 A-115 A and Motor Starters 1,1 kW-55 kW These include control relays, motor contactors, two and four pole output contactors, heating contactors, thermal overload relays.	200
Push Buttons and Pilot Lights, 22,5 mm Ø A complete range of state-of-the-art push buttons and pilot lights represent an ideal combination of functional security and economical efficiency in a modular design.	302

SALES AND SERVICE ORGANIZATION

Australia

australian solenoid Φ co. pty. ltd.

379 Liverpool Road, ASHFIELD, N.S.W. 2131
P. O. Box 1093, ASHFIELD, N.S.W. 1800
Tel: +61 2 9797-7333, Fax: 0092
e-mail: sales@austrasol.com.au

Austria

austro solenoid Φ ges.m.b.h.

Schumanngasse 35, Postfach 431
A-1181 WIEN
Tel: +43 1 404 06, Fax: 404 06-190
e-mail: aso@krausnaimer.com

Belgium, Luxembourg

solenoid benelux Φ b. v.

Ikaros Business Park
Ikaroslaan 2
B-1930 ZAVENTHEM
Tel: +32 2 757-0141, Fax: 1640
e-mail: sales@bensol.be

Brazil

solenoid do brasil Φ ltda.

Avenida Berna 230
04774-020 SAO PAULO
Tel: +55 11 2198-1288, Fax: 1251
e-mail: knbrasil@krausnaimer.com.br

Canada

canadian solenoid Φ inc.

219 Connie Crescent, Unit 13A
CONCORD, Ontario, L4K 1L4
Tel: +1 905 738-1666, Fax: 9327
e-mail: cdnsolenoid@cansol.on.ca

Chile

ASEA BROWN BOVERI S. A.
Vicuña Mackenna 1602, Casilla 3555
SANTIAGO DE CHILE
Tel: +56 2 544-7411, Fax: 7418

Cyprus

ELECTROMATIC CONSTRUCTIONS LTD.
72, Evagoras Pallikarides Str., CY-2235 LATSIA-Nicosia
P. O. Box 12630, CY-2251 LATSIA-Nicosia
Tel: +357 2 48 41 41, Fax: 48 57 47

Czech Republic

OBZOR, výrobní družstvo Zlín
Louky-Slanica 378
CZ-76413 ZLÍN
Tel: +420 57 7195-111/-153 (Techn. Supp.)
Fax: +420 57 7195-152/-138
e-mail: ots@obzor.cz

Denmark

THIIM A/S
Transformervej 31
DK-2730 HERLEV
Tel: +45 4485 8000, Fax: 8005
e-mail: thiim@thiim.com

Finland

suomen solenoid Φ oy

Karitie 7
FIN-01530 VANTAA
Tel: +358 9 825-424-0, Fax: 424-10
e-mail: etunimi.sukunimi@finsol.fi

France

solenoid france Φ s. a.

33, rue Bobillot
F-75013 PARIS
Tel: +33 1 58 40 80 80, Fax: 45 80 91 19
e-mail: sales@solfrance.fr

Germany

deutsche solenoid Φ vertriebs-gmbh

Wikingerstraße 20-28, D-76189 KARLSRUHE
Postfach 10 01 24, D-76231 KARLSRUHE
Tel: +49 721 59 88-0, Fax: 59 28 28
e-mail: desol@krausnaimer.com

Great Britain

u. k. solenoid Φ ltd.

115 London Road
NEWBURY/BERKSHIRE RG14 2AH
Tel: +44 1635 45991, Fax: 37807
e-mail: sales@uksol.co.uk

Greece

KALAMARAKIS-SAPOUNAS S. A.
Ionias & Neromiliou Str., P. O. Box 46566
GR-13671 ACHARNES/ATHENS
Tel: +30 2 10 240-6000-6, Fax: 240-6007
e-mail: ksa@ksa.gr

Hungary

GANZ, Schalter- u. Gerätefabrik
X, Köbányal út 41/c, Postfach 87
H-1475 BUDAPEST
Tel: +36 1 261-5479, Fax: 4685
e-mail: ganzkk@ganzkk.hu

Iceland

BRAEDURNIR ORMSSON EHF
Lágmúli 6-9, P. O. Box 8670
REYKJAVIK
Tel: +354 530-28 00, Fax: 28 10
e-mail: skuli@ormsson.is

India

Liaison Office, Solenoid Singapore Pte Ltd
12/103, Tulsidham Kalyani CHS Ltd
SV Road, Majiwade
THANE (W) 400610, Maharashtra
Tel: +91 22 2589-8450, Fax: 8450
e-mail: kane.shriram@singsol.co.in

Republic of Ireland

irish solenoid Φ ltd.

Bay 145, Shannon Free Zone
SHANNON, Co. Clare
Tel: +353 61 704700, Fax: 471084
e-mail: salesirs@krausnaimer.ie

Italy

solenoid italia Φ s.r.l.

Via Terracini, 9
I-24047 TREVIGLIO (BG)
Tel: +39 0363-30 11 12, Fax: 30 21 13
e-mail: infoits@italsol.it

Japan

solenoid japan Φ co. ltd.

Yoshiwada Building 2F
1-11-6 Hamamatsucho
Minato-Ku, TOKYO 105-0013
Tel: +81 3 3436-6151, Fax: 6325
e-mail: kazumi.nakazato@japsol.co.jp

Kuwait

AMMAR & PARTNERS ELECTRICAL CO.
P. O. Box 1871
13019 SAFAT
Tel: +965 483-0122/483-0133
Fax: +965 484-1818

Malaysia

INDUSTRIAL AUTOMATION (M) Sdn Bhd
30-3 & 30-4 Loke New Road
55200 KUALA LUMPUR
Tel: +60 3-9-2210511, Fax: 2222299
e-mail: inquiry@iasb.com.my

Mexico

ING. JAVIER CABALLERO B.
A. Gaviño 30, Satélite,
53100, Edo. de Mexico, MEXICO
Tel: +52 5555 62-7577, Fax: 0434
e-mail: j_caballero_b@infosel.net.mx

Netherlands

solenoid benelux Φ b. v.

Wegtersweg 38, Postbus 199
NL-7556 BR HENGEL0 (Ov.)
Tel: +31 74 291-9441, Fax: 8380
e-mail: sales@bensol.nl

New Zealand

new zealand solenoid Φ co. ltd.

42 Miramar Avenue, WELLINGTON 6022
P. O. Box 15-009, WELLINGTON 6243
Tel: +64 4 380-9888, Fax: 9877
e-mail: sales@nzsolenoid.co.nz

Norway

norsk solenoid Φ a/s

Hjalmar Brantings vei 8, P. O. Box 21, Ørkern
N-0508 OSLO
Tel: +47 22 64 44 20, Fax: 65 39 49
e-mail: nos@norsksol.no

Poland

ASTAT sp. z o.o.
ul. Dąbrowskiego 461
PL-60451 POZNAŃ
Tel: +48 61 848-8871/72, Fax: 8276
e-mail: info@astat.com.pl

Portugal

ELECTRICOL-DAMAS, FERREIRA & DAMASCENO, S. A.
Apartado 1083, S. Ant. Cavaleiros
P-2670 LOURES
Tel: +351 21 989-8939, Fax: 988-6464

Singapore

solenoid singapore Φ pte. ltd.

115A, Commonwealth Drive
03-17/23
SINGAPORE 149 596
Tel: +65 6473-8166, Fax: 8643
e-mail: krausnaimer@singsol.com.sg

Slovenia

SCHRACK Energietechnik d.o.o.
Glavni trg 47
SI-2380 SLOVENJ GRADEC
Tel: +386 2 88 392 00, Fax: 434 71
e-mail: schrack.sg@schrack-energietechnik.si

Republic of South Africa

south african solenoid Φ co. pty. ltd.

7 Village Crescent, Linbro Village
Linbro Business Park, SANDTON 2065
P. O. Box 511, KELVIN 2054
Tel: +27 11 608-6060, Fax: 608-2874
e-mail: sales@sasolenoid.co.za

Spain

HAZEMEYER ESPAÑOLA S. A.
Ctra. de Tiana s/n, Esq. N-2
BADALONA-BARCELONA
Tel: +34 93 389-4262, Fax: 384-3586
e-mail: konno@grupo-hes.net

Sweden

skandinaviska solenoid Φ ab

Dr. Widerströms Gata 11, FRUÅNGEN
Box 42097, S-126 14 STOCKHOLM
Tel: +46 8 97 00 80, Fax: 97 87 33
e-mail: order@skansol.se

Switzerland

AWAG Elektrotechnik AG
Sandbühlstraße 2, Postfach
CH-8604 VOLKETSCHWIL
Tel: +41 44 908 19 19, Fax: 19 99
e-mail: info@awag.ch, www.awag.ch

Taiwan

NUWTEC ENTERPRISE Co Ltd
No. 301, Sec. 1, Nan Kang Road
TAIPEI 115, Taiwan, R. o. C.
Tel: +886 2 265-13279, Fax: 13264
e-mail: nathan.nuwtec@msa.hinet.net

Turkey

ÜNAL KARDEŞ ELEKTRİK GEREÇLERİ A. Ş.
Beşyol, Eski Londra Asfaltı-6
TR-34295 İSTANBUL-Sefaköy
Tel: +90 212 624-9204, Fax: 592-4810
e-mail: info@unal kardes.com.tr

USA

american solenoid Φ co. inc.

760 New Brunswick Road
SOMERSET, NJ 08873
Tel: +1 732 560-1240, Fax: 8823
e-mail: amsol@krausnaimer-us.com

