

# 32" Wide LCD Color TV



Model: **LT-32HEP/HLP**

## **Owner's Manual**



# Warnings

---



**WARNING**  
RISK OF ELECTRIC SHOCK  
DO NOT OPEN



## **WARNING :**

To reduce the risk of electric shock do not remove cover (or back).  
No user serviceable parts inside. Refer servicing to qualified service personnel.



The lightning flash with arrowhead symbol, within an equilateral triangle, is intended to alert the user to the presence of uninsulated “dangerous voltage” within the product’s enclosure that may be of sufficient magnitude to constitute a risk of electric shock to persons.



The exclamation point within an equilateral triangle is intended to alert the user to the presence of important operating and maintenance (servicing) instructions in the literature accompanying the appliance.

## **WARNING :**

To prevent fire or shock hazard, do not expose the set to rain or moisture. Do not rub or strike the Active Matrix LCD with anything hard as this may scratch, mar, or damage the Active Matrix LCD permanently.

## **CAUTION:**

Do not attempt to modify this product in any way without written authorization. Unauthorized modification could void the user’s authority to operate this product.

## **Service**

Never remove the back cover of the TV, this can expose you to high voltage and other hazards. If the TV does not operate properly, unplug it and call your dealer. Antenna Connect the antenna cable to the connection marked Ant. (on the rear). For best reception, use an outdoor antenna.

# Warnings

---

## Location

Position your TV so that no bright light or sunlight will shine directly on the screen. Do not expose the TV to vibration, moisture, dust or heat. Also ensure that the TV is placed in a position that allows a free flow of air. Do not cover the ventilation openings on the back cover. You can place it on a table-top.

## Cleaning

Unplug the TV before cleaning the face of the LCD Screen. Dust the TV by wiping the screen and cabinet with a soft, clean cloth. If the screen requires additional cleaning, use a clean, damp cloth. Do not use liquid or aerosol cleaners.

## POWER

The main plug should be inserted fully into the power outlet to avoid a fire hazard. Hold the plug firmly when unplugging. If you pull the cord, the cord may be damaged. Prevent dust collecting on the power plug pins or outlet. And do not use too many plugs on the Mains multi-outlet. It may result in overheating of the outlet and causes a fire hazard.

Never touch the power plug with a wet hand. This may cause an electric shock hazard. Unplug the set from the wall outlet when it is left unattended and unused for long periods of time. Accumulated dust may cause a fire or an electric shock from deterioration or electric leakage.



# Contents

Before operating the set, please read this manual carefully.

<b>Warnings</b> .....	2~3
<b>Contents</b> .....	5
<b>Supplied Accessories</b> .....	6
<b>Controls</b> .....	7~9
Controller of panel .....	7
Remote controller .....	8~9
<b>Basic Operation</b> .....	10
On and off .....	10
Programme selection .....	10
Volume adjustment .....	10
Q.View .....	10
Mute Function .....	10
On screen Language selection .....	10
<b>On Screen Menus and Displays</b> .....	11
<b>Setting up TV Programme</b> .....	12~14
Auto Programme .....	12
Manual Programme .....	13
Programme edit .....	14
<b>Picture Control</b> .....	15
Manual picture setup .....	15
Auto picture setup .....	15
<b>Sound Control</b> .....	16
<b>Other functions</b> .....	17~18
TV, SCART1, SCART2 and S-VIDEO mode .....	17
Auto sleep .....	17
Blue Back .....	18
ARC(Aspect Ratio Control) .....	18
Sleep timer .....	18
Sound output selection .....	18
PIP function .....	18
Programme list .....	19
<b>TELETEXT</b> .....	20~21
Text On/Off .....	20
TOP text .....	20
FLOF text .....	20
Special Text function .....	21
<b>External Equipment Connection</b> .....	22~23
Antenna IN .....	22
SCART 1/2 .....	22
S-VIDEO IN .....	23
Headphone OUT .....	23
Sub woofer OUT .....	23
<b>Connecting PC as monitor</b> .....	24~25
<b>Product specifications</b> .....	26
<b>Troubleshooting</b> .....	27
<b>Limited Warranty</b> .....	28

# Supplied Accessories

## ■ Make sure the following accessories are provided with Product.

1. AC cord



2. Batteries (2EA)

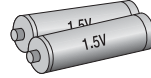

3. Remote controller



5. Owner's manual

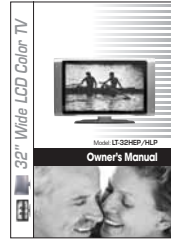

4. PC ANALOG IN cable

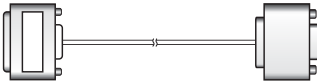

6. PC AUDIO IN cable

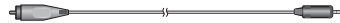

## Battery installation

### ■ Inserting batteries

1. Remove the battery cover by pulling it upward in the direction shown by the arrow.
2. Insert the batteries with correct polarity ( "+" to "+", and "-" to "-" ).
3. Replace the battery compartment cover.

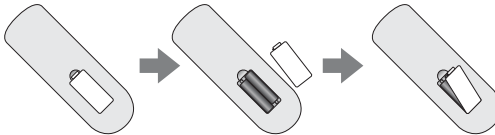

\*Install two high-quality 1.5V "AAA" alkaline batteries. Don't mix old batteries with new batteries.

\*Remove batteries when you won't use the remote controller for long time. Liquid leakage from old batteries may cause operation failure.

### ■ Notes for using remote controller

- Make sure there are no objects between the remote controller and its sensor.
- Don't place the remote control near a heater or in damp place. Strong impact to the remote control may cause operation failure.
- Signal from the remote control may be disturbed by sun light or other bright light. In this case, darken the room or move the TV.

# Controls

**1. ON/OFF** Switches TV set on or off.

**2. MENU**

Displays a menu.

**3. + PR -** (Programme Up/Down)

Selects a programme or a menu item.

**4. + VOL -** (Volume Up/Down)

Adjusts the volume./ Adjusts menu settings.

**5. TV/AV** Selects TV, SCART1, SCART2, S-VIDEO, PC-ANALOG or PC-DIGITAL mode./ Clears the menu from the screen.

**6. Power Indicator**

Illuminates in red when the TV is in standby mode./ Illuminates in green when the TV is switched on. Illuminates in blinked when the power save mode(only PC mode).

**7. Remote control sensor**

Accepts the IR signal of remote controller.

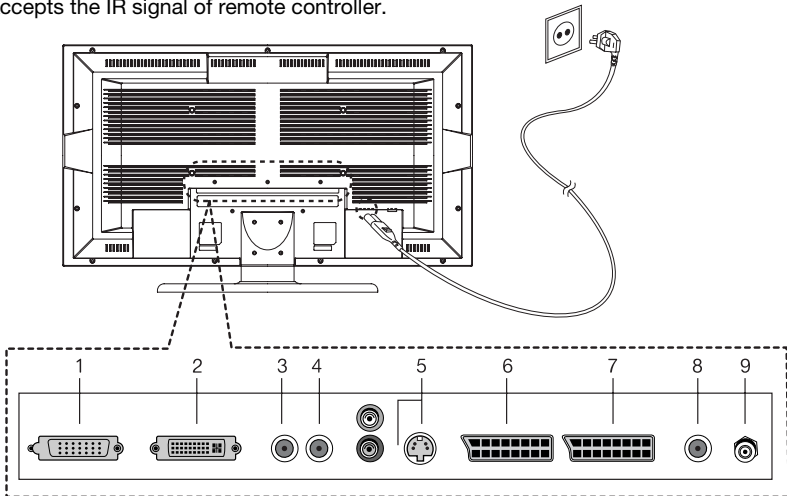
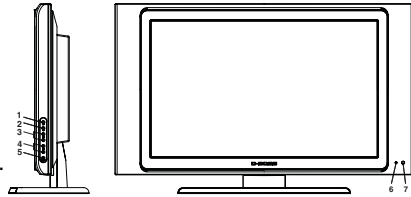

**1. PC ANALOG IN (D-SUB)**

**2. PC DIGITAL IN (DVI-I)**

**3. PC AUDIO IN**

Connect the audio cable from the PC to the **PC AUDIO IN** of the set.

**4. H/P (Headphone out)**

Connect a headphone to this socket.

**5. S-VIDEO IN**

Connect the output of an S-VIDEO VCR to the S-VIDEO input.

Connect the audio outputs of an S-VIDEO VCR to the Audio IN (L(MONO), R).

**6. SCART2**

**7. SCART1**

Connect the Audio/Video outputs of external equipment to scart jack.

**8. Sub woofer OUT**

Connect the cable from the Sub woofer to the **Sub woofer OUT** of the set.

**9. Ant. (Antenna input)**

# Controls

All the functions can be controlled with the remote controller. Some functions can also be adjusted with the buttons on the front panel of the set.

## Remote controller

Before you use the remote controller, please install the batteries.

### 1. POWER

Turns the TV on from standby or off to standby mode.

### 2. MUTE

Turns the sound on and off.

### 3. NUMBER buttons

Selects programme numbers.

### 4. PSM (Picture Status Memory)

Recalls your preferred picture setting

### 5. SSM (Sound Status Memory)

Recalls your preferred sound setting

### 6. I/II

Selects the language during dual language broadcast.  
Selects the sound output.

### 7. MENU

Displays a main menu.

### 8. TV/AV

Selects TV, SCART1, SCART2, S-VIDEO, PC-Analog or PC-Digital mode.  
Clears the menu from the screen.

### 9. SLEEP

Sets the sleep timer.

### 10. TV/PC

Selects TV or PC mode directly.

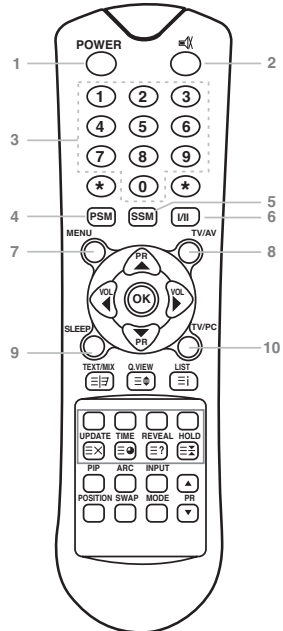

# Controls

## 11. PR ▲ ▼ (Programme Up/Down)

Selects next programme or a menu item.

## 12. VOL ◀ ▶ (Volume Up/Down)

Adjusts the sound level.

Adjusts menu settings.

## 13. OK

Accepts your selection or displays the current mode.

## 14. TELETEXT Buttons

These buttons are used for TELETEXT.

For further details, see the 'TELETEXT' section.

## 15. Q.VIEW

Returns to the previously viewed programme.

**Note:** In TELETEXT mode,

The **Q.VIEW** button is used for TELETEXT function.

## 16. LIST

Displays the programm list menu.

## 17. PIP

Displays a PIP(Picture In Picture) screen.

## 18. ARC

Selects a screen mode- 16:9, 14:9, ZOOM 1:1 and Auto Wide.

## 19. INPUT

Selects the AV source of sub picture in PIP mode.

## 20. POSITION

Selects a position of PIP screen.

## 21. SWAP

Switches a main picture for sub picture in PIP mode.

## 22. MODE

Selects a PIP screen mode. – 16:1, 9:1, double window and scan mode

## 23. ▲ PR ▼

Selects a programme when RF signal is displayed in PIP mode.

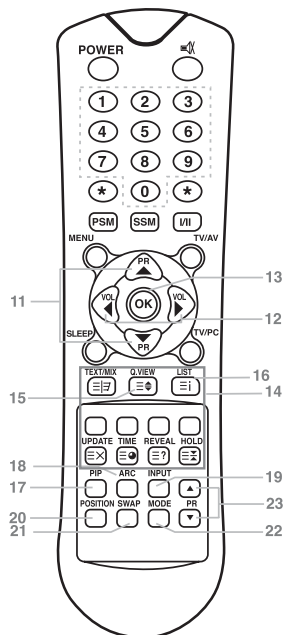

# Basic Operation

## Turning the TV On and Off

**Standby Setup:** The AC power cord must be set up and connected to have the TV in standby mode ready to be turned on. Press the ON/OFF button on the side panel of the TV to go into standby mode.

1. If the TV is in standby mode, press the **POWER** button on the remote controller or the TV itself to turn the TV on.
2. Press the **POWER** button again on the remote controller or the TV itself to turn the TV off.

**Note :** If the TV is on and the **POWER** button is pressed to turn the TV off, the TV goes into standby mode.

## Programme selection

You can select a Programme number with the **PR▲▼** button or **NUMBER** buttons.

## Volume adjustment

Press the **VOL◀▶** button to adjust the sound level.

## Quick view

Press the **Q.VIEW** button to view the last channel you were watching.

## Sound mute function

Press the **MUTE** button. The sound is switched off and the mute display  appears.

To cancel mute mode, press the **MUTE** button again, **VOL◀▶** or **SSM** button.

## On screen menu language selection

The menu can be displayed on the screen in desired language.

First select your language.

1. Press the **MENU** button.
2. Select the **Setup** menu.
3. Select the **Language**.
4. Press the **PR▲▼** button to select your desired language.
5. Press the **TV/AV** button.

All the on screen menu will appear in the selected language.

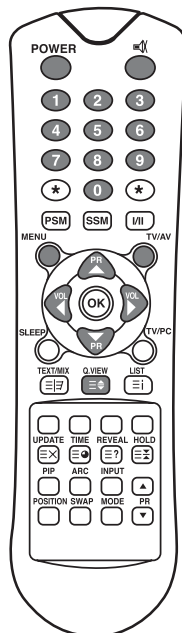

# On Screen Menus and Display

1. Press the **MENU** button to display main menu.
2. Press the **PR ▲▼** button to select menus-Picture, Sound, Special, Setup.
3. Adjust each menu with the **VOL◀▶** button.
4. Press the **MENU** button to return to preceding menu.
5. Press the **TV/AV** button to finish adjusting menu.

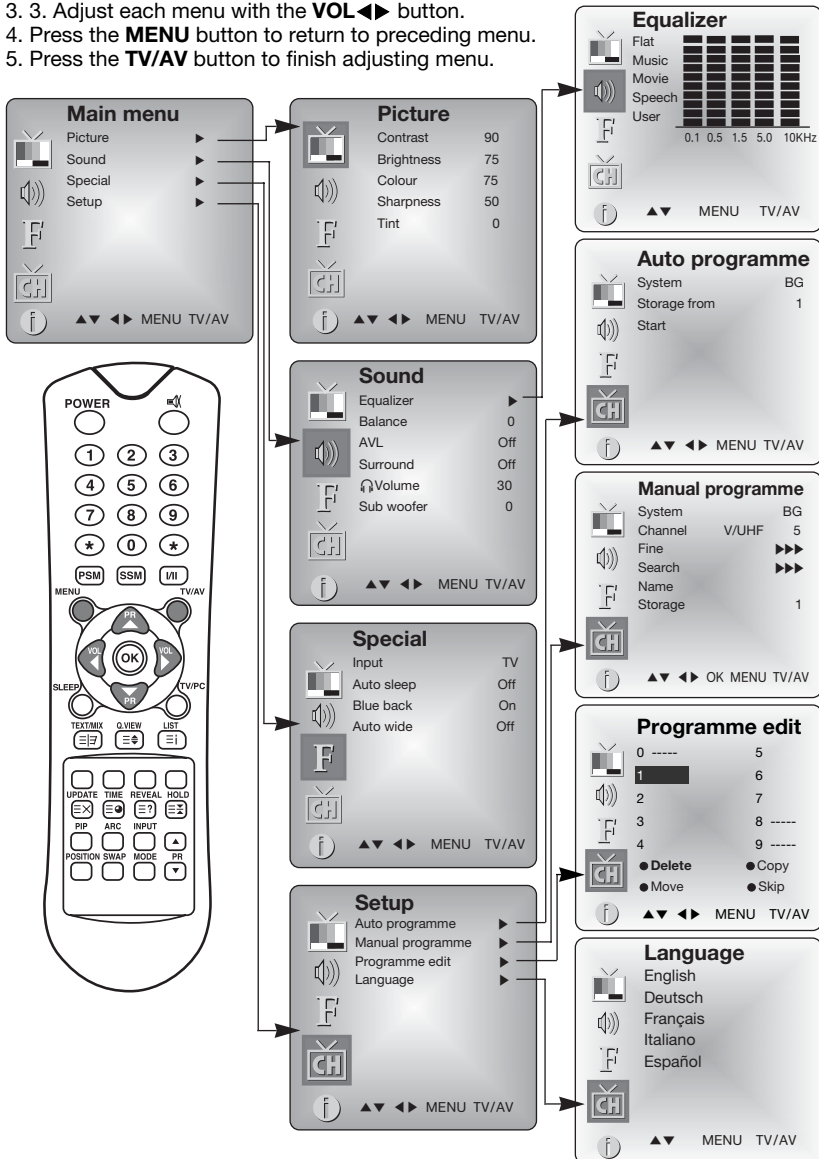

# Setting up TV Programme

Once you have preset the programme, you will be able to use the **PR▲▼** or **NUMBER** buttons to scan the programme you programmed. Programme can be tuned using Auto or Manual programme menu.

## Auto Programme

All programme that can be received are stored by this method. It is recommended that you use Auto programme during installation of this set.

1. Press the **MENU** button.
2. Select the **Setup** menu.
3. Select the **Auto programme** menu.
4. Press the **PR▲▼** button to select **System**.
5. Select a TV system with the **VOL◀▶** button;  
**BG** : (West Europe/Asia/M.East/Africa/Australia)  
**I** : (UK/Hong Kong/South Africa)  
**DK** : (Russia/China/East Europe)  
**L** : (France) (\*Only LT-32HLP Model)
6. Press the **PR▲▼** button to select **Storage from**.
7. Select the beginning programme number with the **PR▲▼** button or **NUMBER** buttons.
8. Start Auto programme, press the **MENU** button to finish auto programme
9. Press the **TV/AV** button to finish Auto programme.
10. Press the **TV/AV** button to return to normal TV viewing.

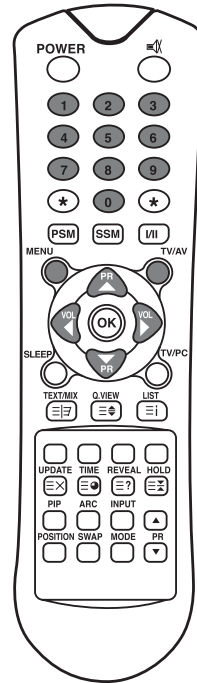
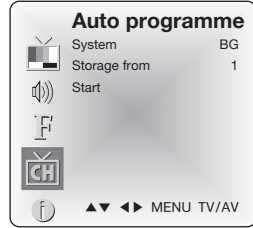

# Setting up TV Programme

## Manual Programme

Manual Programme lets you manually tune and arrange the programme in whatever order you desire. Also you can assign a programme name with 5 characters to each programme number.

1. Press the **MENU** button.
2. Select the **Setup** menu.
3. Select **Manual programme** menu.
4. Press the **PR▲▼** button to select **System**.
5. Select a TV system with the **VOL◀▶** button.
  - BG** : (West Europe/Asia/M.East/Africa/Australia)
  - I** : (UK/Hong Kong/South Africa)
  - DK** : (Russia/China/East Europe)
  - L** : (France) (\*Only LT-32HLP Model)
6. Press the **PR▲▼** button to select **Channel**.
7. Press the **VOL◀▶** button to select **V/UHF or Cable** as required. If possible, select the programme number directly with the number buttons.
8. Press the **PR▲▼** button to select **Search**. Press the **VOL◀▶** button to commence searching. If a channel is found the search will stop.
9. If this programme is the one required, press the **PR▲▼** button to select **Storage**. Select the desired programme number with the **VOL◀▶** button or **NUMBER** buttons.
10. Press the **OK** button to store it. The display **Stored** will appear.

To store another programme, repeat steps 5 to 10.

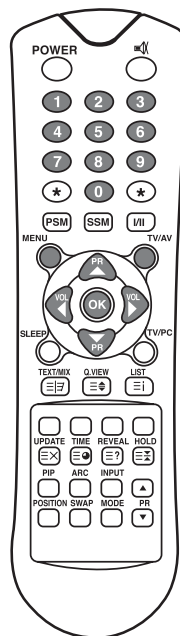
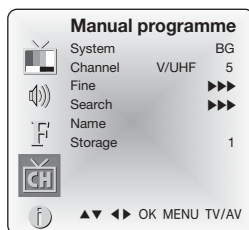

# Setting up TV Programme

## Programme edit

This function enables you to delete, copy, move or skip or skip the stored programme.

Also you can move some programme to other programme numbers or insert a blank programme data into the selected programme number.

1. Press the **MENU** button.
2. Select the **Setup** menu.
3. Press the **PR▲▼** button select **Programme edit**.  
Select the programme name to edit with the **PR▲▼** and **VOL◀▶**.

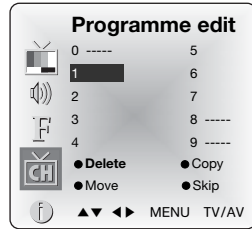

### Deleting a programme

1. Select a programme to be deleted with the **PR▲▼** or **VOL◀▶** button.
2. Press the **RED** button twice.  
The selected programme is deleted, all the following programme is shifted up one position.

### Copying a programme

1. Select a programme to be copied with the **PR▲▼** or **VOL◀▶** button.
2. Press the **GREEN** button.  
All the following programmes are shifted down one position.

### Moving a programme

1. Select a programme to be moved with the **PR▲▼** or **VOL◀▶** button.
2. Press the **YELLOW** button.
3. Move the programme to desired programme number with the **PR▲▼** or **VOL◀▶** button.
4. Press the **YELLOW** button again to release this function.

### Skipping a programme number

1. Select a programme number to be skipped with the **PR▲▼** or **VOL◀▶** button.
2. Press the **CYAN** button. The skipped programme turns to blue.
3. Press the **CYAN** button again to release the skipped programme.

**Note:** When a programme number is skipped it means that you will be unable to select it using the **PR▲▼** button during normal TV viewing. If you want to select the skipped programme, directly enter the programme number with the **NUMBER** buttons or select it in the programme edit or table menu.

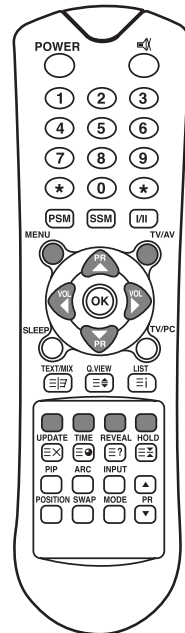

# Picture Control

You can adjust picture Contrast, Brightness, Colour, Sharpness and Tint to the levels you prefer.

## Manual Picture Control

1. Press the **MENU** button.
2. Select the Picture.
3. Press the **PR**▲▼ buttons to select a picture item.
4. Press the **VOL**◀▶ buttons to adjust the picture condition as you want.
5. Press the **TV/AV** button to store for the picture User.

Selected Item	Setting Change
Contrast	More darkness VOL◀ 0~100 ▶VOL More light
Brightness	Less bright VOL◀ 0~100 ▶VOL More bright
Color	Lower color intensity VOL◀ 0~100 ▶VOL Higher color intensity
Sharpness	Soft picture VOL◀ 0~100 ▶VOL Hard picture
Tint	More purple◀ 50~50 ▶More green

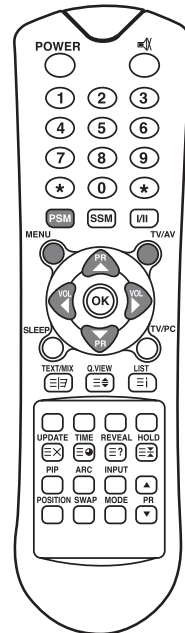
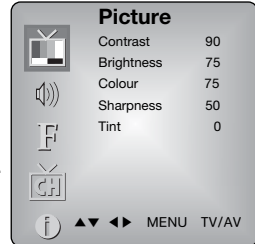

## Auto Picture Control

### PSM (Picture Status Memory)

1. Press the **PSM** button.
2. Press the **PSM** button repeatedly to select [PSM].

Each press of the button changes the screen display as below.

Dynamic → Standard → Mild → Game → User



- **Dynamic** : Vivid Picture Appearance
- **Standard** : Standard Picture Appearance
- **Mild** : Softer Picture Appearance
- **Game** : External Video Game Picture Setup
- **User** : Manual Picture Setup

# Sound Control

You can select your preferred sound setting; Flat, Music, Movie or Speech and you can also adjust the sound frequency of equalizer, balance. If you switch AVL to on, the set automatically keeps on an equal volume level even if you change programme.

1. Press the **MENU** button.
2. Select the **Sound** menu.
3. Press the **PR▲▼** button to select the desired sound item; **Equalizer**, **Balance**, **AVL Surround** or **headphone Volume**.
4. Press the **VOL◀▶** button to make desired adjustment.
5. Press the **VOL◀▶** button in **Equalizer** to set the **Equalizer**.
6. Press the **PR▲▼** button to select your preferred setting ; **Flat**, **Music**, **Movie**, **Speech** or **User**.  
To set the **Equalizer User**.
  - a. Select **User** by pressing the **PR▲▼** button.
  - b. Select a sound band by pressing the **VOL◀▶** button.
  - c. Make appropriate sound level with the **PR▲▼** button.
  - d. Press the **MENU** button to return to preceding MENU and the **TV/AV** button to return to normal TV viewing.
7. Select the Balance menu and adjust the balance of speakers.
8. Select the AVL(Automatic Volume Leveler) menu On or Off
9. Select the Surround menu On or Off.
10. Select the  Volume menu and adjust the volume from headphone.
11. Select the Sub woofer menu to adjust the bass volume.(It is possible when the Sub woofer is connected to the set.)

※ The sound **Flat**, **Music**, **Movie** and **Speech** are programmed for good sound reproduction at the factory and cannot be changed.

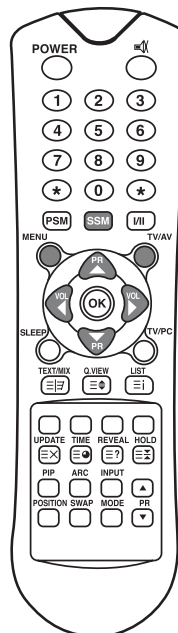
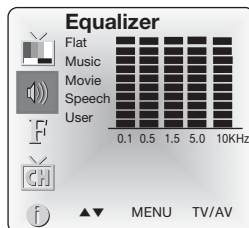
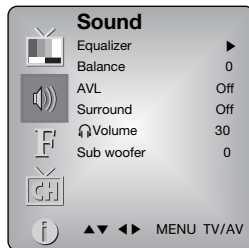

## Auto Sound Control

### SSM (Sound Status Memory)

1. Press the **SSM** button.
  2. Press the **SSM** button repeatedly to select.
- Each press of the button changes the screen display as below.

Flat → Music → Movie → Speech → User



# Other functions

## TV, SCART1, SCART2 and S-VIDEO modes

(You can't set PC mode in this menu. Use the TV/AV button)

External equipment inputs:S-VIDEO mode are used for video devices like VCRs, DVDs, etc.), SCARTmode is used for SCART type devices.

**Note** : If a VCR is connected to the antenna jack, use TV mode. See External Equipment Connection section.

1. Press the **MENU** button.
2. Select the **Special** menu.
3. Press the **PR ▲▼** button to select **Input**.
4. Press the **VOL ◀▶** button to select **TV, SCART1, SCART2 and S-VIDEO**.

**SCART1** : AV device connected to the SCART2 jack.

**SCART2** : AV device connected to the TV's SCART1 jack.

**S-VIDEO** : S-VIDEO device connected to the TV's S-VIDEO Input.

To return to TV mode, press the **TV/AV** button.

Alternatively you can select the TV, SCART1, SCART2, S-VIDEO, PC-ANALOG or PC-DIGITAL mode by pressing the **TV/AV** button.

## Auto sleep

If you select **Auto sleep on** the set will automatically switch itself to standby mode approximately ten minutes after a TV Channel stops broadcasting.

1. Press the **MENU** button, select the Special menu.
2. Press the **PR ▲▼** button to select **Auto sleep**.
3. Press the **VOL ◀▶** button to select **On**.
4. Press the **TV/AV** button to return to normal TV viewing.

## Blue back

Programme without a program signal appear in blue.

## Auto wide (Aspect Ratio Control)

Press the ARC button to select a desired picture format. Each press of the ARC button, selects Auto Wide, 16:9, 14:9, ZOOM, 1:1 and Auto wide mode.

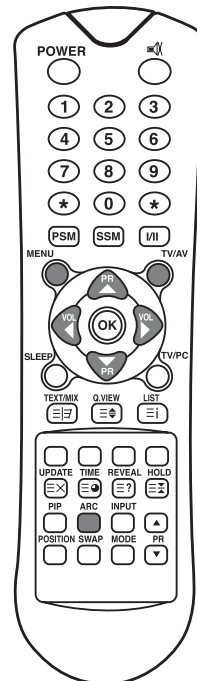
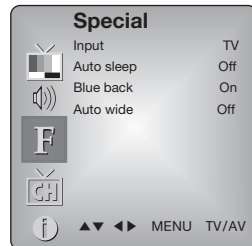

# Other functions

## Sleep timer

You don't have to remember to switch the set off before you go to sleep. The sleep timer automatically switches the set to standby after the preset time elapses.

Press the **SLEEP** button to select the number of minutes. The display **will** appear on the screen, followed by **0, 10, 20, 30, 60, 90, 120, 180 and 240**. The timer begins to count down from the number of minutes selected.

### Note:

- To view the remaining sleep time, press the **SLEEP** button once.
- To cancel the sleep time, Select 0 with the **SLEEP** button.

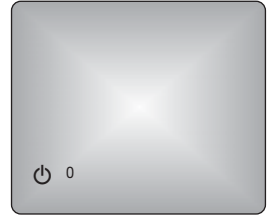

## Sound output selection

In VIDEO mode, you can select output sound for the left and right loudspeakers. Repeatedly press the **I/II** button to select the sound output.

**L+R** : Audio signal from audio L input is sent to left loudspeaker and audio signal from audio R input is sent to right loudspeaker.

**L+L** : Audio signal from audio L input is sent to left and right loudspeakers.

**R+R** : Audio signal from audio R input is sent to left and right loudspeakers.

## PIP function

PIP will let you view two separate source inputs on your TV screen at the same time.

### Viewing the PIP picture

Press the **PIP** button. (Press the PIP button again, to turn PIP off.)

### Selecting the PIP picture mode

Press the **MODE** button to adjust the PIP picture mode. Each press the **MODE** button, selects the 16:1, 9:1, double window and multi picture mode. (Multi picture mode is just available when the main picture is in AV mode.)

### Moving the PIP picture

Press the **POSITION** button to adjust the position of sub picture in PIP mode.

### Switching the main and PIP picture

Press the **SWAP** button to switch the main and sub picture in PIP mode.

### Viewing the external source input

Press the **INPUT** button to select the input source of sub picture in PIP mode. Press the **PR▲▼** button to select the programme desired in TV mode of sub picture.

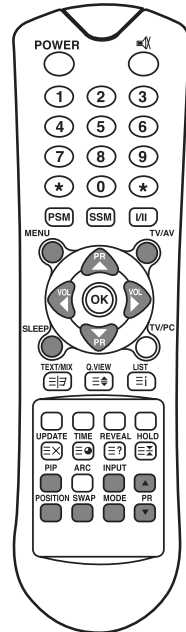

# Other functions

## Calling the programme list

You can check the programmes stored in the memory by displaying the programme LIST.

### Displaying programme list

1. Press the **LIST** button to display the Programme list menu. The programme list appears on the screen.

One programme list contains ten programmes as right.

### Note :

- a. You may find some blue programmes. They have been set up to be skipped by auto programming or in the programme edit mode.
- b. Some programmes with the channel number shown in the programme list indicate there is no station name assigned.

### Selecting a programme in the programme list

Select a programme with the **PR▲▼** or **VOL◀▶** button. Then press the **OK** button.

The set switches to the chosen programme number.

### Paging through a programme list

There are 10 programme table pages in which contain 100 programmes.

Pressing the **PR▲▼** or **VOL◀▶** button repeatedly turns the pages.

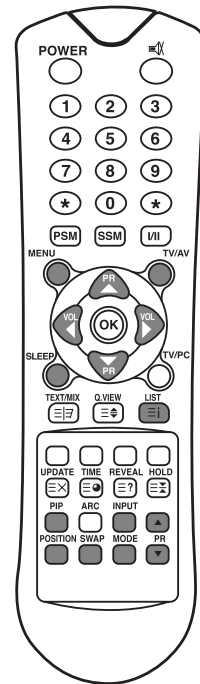
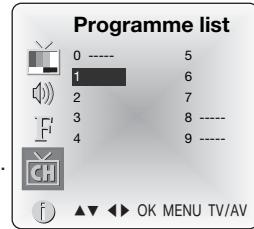

# TELETEXT

## TEXT On/Off

Press the **TEXT/MIX** button to switch to TELETEXT. The initial page or last selected page appears on the screen. The first page number indicates your selection, while the second shows the current page displayed.

1. Press **TEXT/MIX** button once, displays the TELETEXT pages.
2. Press **TEXT/MIX** button once more, displays the TELETEXT pages superimposed on the TV picture.
3. Press the **TEXT/MIX** button to switch off TELETEXT once more, Text mode is off, and TV mode appears.

If you press **TEXT/MIX** button displays are changed as below.

**TEXT → MIX → TV mode**



## TOP text

The user guide displays four fields—red, green, yellow and blue at the bottom of the screen. The yellow field denotes the next group and the blue field indicates the next block.

### Group/block/page selection

1. With the **BLUE** button you can progress from block to block.
2. Use the **YELLOW** button to proceed to the next group with automatic overflow to the next block.
3. With the **GREEN** button you can proceed to the next existing page with automatic overflow to the next group. Alternatively the **PR▲** button can be used.
4. The **RED** button permits to return to previous selection. Alternatively the **PR▼** button can be used.

## FLOF text

The Teletext pages are colour coded along the bottom of the screen and are selected by pressing the corresponding coloured button.





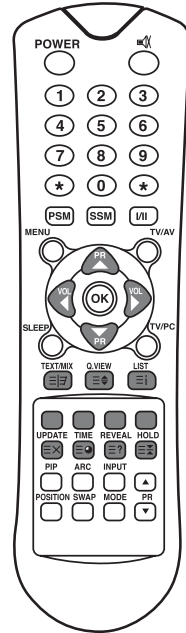

### Page selection

1. Press the **INDEX** button to select the index page.
2. You can select the pages, which are colour coded along the bottom line with the same coloured buttons.
3. The **VOL◀▶** button can be used to select the preceding or following page.



# TELETEXT

## Special TELETEXT functions

MENU		Functions
	<b>TEXT/MIX</b>	Changes TELETEXT mode ; Only TELETEXT mode, text mode superimposed on the TV picture, TV mode.
	<b>SIZE</b>	Selects double height text. Press this button to enlarge the top half of the page. Press this button again to enlarge the bottom half of the page. Press this button again to return to the normal display.
	<b>HOLD</b>	Stops the automatic page change, which will occur if a TELETEXT page consists of 2 or more sub pages. The number of sub pages and the sub page displayed is, usually, shown on the screen below the time. When this button is pressed the stop symbol is displayed at the top left-hand corner of the screen and the automatic page change is inhibited. To continue press this button again.
	<b>INDEX</b>	Return to index page
	<b>UPDATE</b>	Displays the TV picture on the screen while waiting for the new TELETEXT page. The display will appear at the top left hand corner of the screen. When the updated page is available then display will change to the page number. Press this button to view the updated TELETEXT page.
	<b>TIME</b>	When viewing a TV programme, press this button to display the time at the top right hand corner of the screen. Press this button again to remove the display. In TELETEXT mode press this button to select and hold or change a four-digit sub page number. This is displayed along the bottom of the screen. Press this button again to exit this function.
	<b>REVEAL</b>	Press this button to display the concealed information, such as solutions of riddles or puzzles. Press this button again to remove the information from the display.

# External Equipment Connection

You can connect additional equipment, such as VCRs, camcorders etc. to your set. Examples are shown below.

## Antenna connection

1. Connect RF out on the VCR to the Antenna input on the rear of the TV.
2. Connect the antenna cable to the antenna in jack on the VCR.
3. Use the TV/AV button to select TV mode.
4. Press the PLAY button on the VCR.

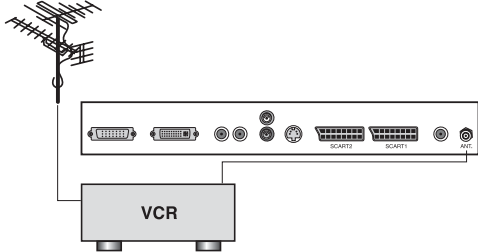

## SCART 2

1. Connect the AV out jacks on the AV device to the SCART on the TV.
2. Use the TV/AV button to select SCART2 mode.
3. Press the PLAY button on the DVD.

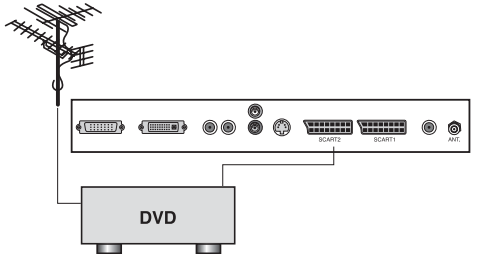

## SCART 1

1. Connect the A/V out jacks on the AV device to SCART jack on the TV.
2. Use the TV/AV button to select SCART1 mode.
3. Press the PLAY button on the VCR. The VCR playback picture appears on the TV screen.

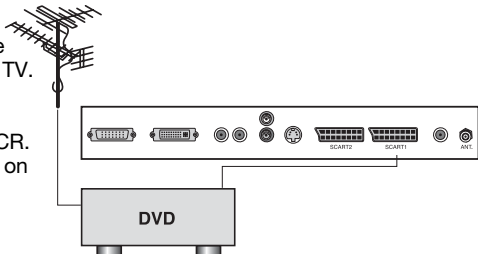

# External Equipment Connection

## S-VIDEO input

If using an **S-VIDEO** source, the picture quality will be improved over a video source.

1. Connect the S-VIDEO output of a VCR to the **S-VIDEO** input on the TV.
2. Connect the audio cables from the S-VIDEO VCR to the **L (MONO) R** inputs on the TV.
3. Select **S-VIDEO** mode by pressing the **TV/AV** button repeatedly.
4. Press the **PLAY** button on the VCR.  
The VCR playback picture appears on the screen.

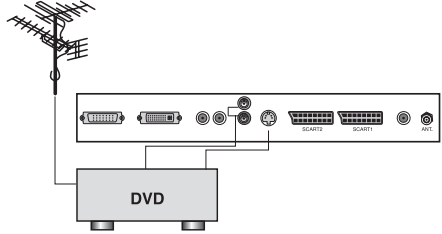

## Headphone jack

Insert the headphone plug to the headphone jack on the TV. You can listen to the sound through the headphone; no sound from the speaker on the TV. To adjust the headphone volume, use the  Volume menu in the Sound menu.

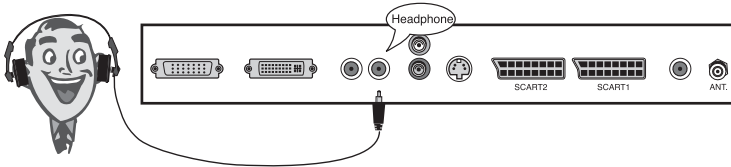

## Sub woofer output

Connect the cable of the sub woofer to the sub woofer output on the TV. You can listen to the bass well. To adjust the bass volume, use the Sub woofer menu in the sound menu.

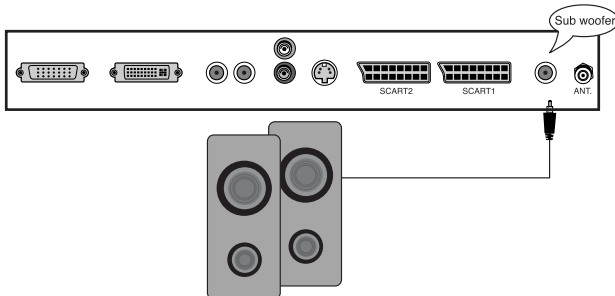

# Connecting the PC as a monitor

## Picture adjustment

You can adjust picture Contrast, Brightness, Horizontal/Vertical position, Clock, Phase, Auto and Reset as you prefer.

1. Press the **TV/AV** or **TV/PC** button to select the PC mode.
2. Press the **MENU** button.
3. Press the **PR▲▼** button to select the desired picture item.
4. Press the **VOL◀▶** button to make appropriate adjustments.

- |   |   |
|---|---|
|  Contrast    |  Clock |
|  Brightness  |  Phase |
|  Temperature |  Auto  |
|  H-position  |  Reset |
|  V-position  |   |

### Contrast

This function is to adjust picture to light/dark.

### Brightness

This function is to adjust brightness of picture.

### Temperature

Temperature is a measure of the warmth of the image color.

### Horizontal Position/Vertical Position

This function is to adjust picture to left/right and up/down as you prefer.

### Clock

This function is to minimize any vertical bars or stripes visible on the screen background. And the horizontal screen size will also change.

### Phase

This function allows you to remove any horizontal noise and clear or sharpen the image of characters.

### Auto

This function is for the automatic adjustment of the screen position, clock and clock phase. The displayed image will disappear for a few seconds while the Auto-configuration is in process.

**Note:** Some signal from some graphics boards may not function properly. If the results are unsatisfactory, adjust your monitor's position, clock and clock phase manually.

### Reset

This function allows you to return to the good picture reproduction programmed at the factory and cannot be changed.

5. Press the **TV/AV** button to exit menu.

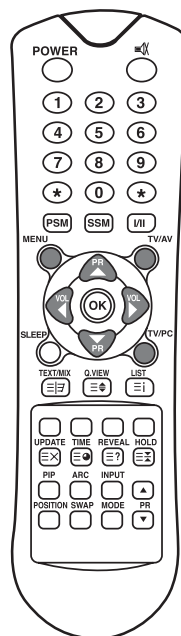
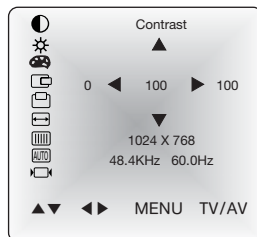

# Connecting the PC as a monitor

## PC/DTV INPUT

1. Connect the PC IN cable (D sub jack) from the monitor output socket of the PC to the PC/DTV input socket of the set.
2. Connect the PC AUDIO IN cable from the PC to the **PC AUDIO IN** of the set.
3. Press the **TV/AV** or **TV/PC** button to select **PC ANALOG IN** mode.
4. Switch on the PC, and the PC screen appears on the set.

The set can be operated as the PC monitor.

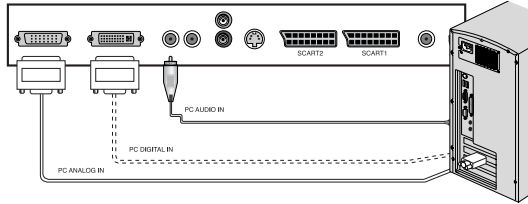

## DVI (Digital Visual Interface) INPUT

1. Connect the DVI of PC to the **DVI** input on the TV.
2. Select **PC-DIGITAL** mode by pressing the **TV/AV** button repeatedly. (When DVI source is connected, TV/AV mode converts PC to DVI mode.)

## Resolution

Mode	Resolution	Horizontal frequency (KHz)	Vertical frequency (Hz)
VGA	640X480	31.5 KHz	60 Hz
	640X480	35 KHz	67 Hz
	640X480	37.9 KHz	72 Hz
	640X480	37.5 KHz	75 Hz
	720X400	31.5 KHz	70 Hz
SVGA	800X600	35.2 KHz	56 Hz
	800X600	37.9 KHz	60 Hz
	800X600	48.1 KHz	72 Hz
	800X600	46.9 KHz	75 Hz
XGA	1024X768	48.4KHz	60Hz
	1024X768	56.5 KHz	70 Hz
	1024X768	60.2 KHz	75 Hz
WXGA	1280X768	47.7 KHz	60 Hz

## Note:

- a. If possible, use the VESA 1,024x768@60Hz video mode to obtain the best image quality for your LCD monitor. If used under the other resolutions, some scaled or processed pictures may appear on the screen. The set has been pre-adjusted to the mode VESA 1,024x 768 @60Hz.
- b. Some dot defects may appear on the screen, like Red, Green or Blue spots. However, this will have no impact or effect on the monitor performance.

# Product Specifications

Model	LT-32HEP/HLP	
Main body	Horizontal size 930 mm	Thickness 112(210) mm
	Height 503(560) mm	Weight 17.6(19.3) kg
Television system	LT-32HEP: PAL-BG, I, DK/ SECAM-BG, DK LT-32HLP: PAL-BG, I, DK/ SECAM-BG, DK, L	
Television programme	VHF: 2~13 UHF: 21~69 Cable: S1~S41	
LCD Panel	32" wide TFT LCD panel	
Power consumption	150W	
External antenna impedance	75Ω	
Audio output	10W + 10W	
External IN/OUT ports	<ul style="list-style-type: none"> <li>• DVI-IN</li> <li>• HEADPHONE JACK</li> <li>• PC AUDIO IN</li> <li>• SUB WOOFER OUT</li> <li>• S-VIDEO IN</li> <li>• PC IN</li> <li>• SCART 1 IN</li> <li>• SCART 2 IN</li> <li>• ANTENNA IN</li> </ul>	
AC Input	AC 100-240V, 2.5A~1.5A, 50/60Hz	

# Troubleshooting

Problem	Check item
No picture on screen and no sound from speakers.	<ul style="list-style-type: none"> <li>• Insert the AC power cord plug securely in AC power outlet.</li> <li>• Make sure the remote control is not in the standby mode (The POWER/Standby indicator is red.)</li> <li>• Turn on the MAIN POWER button on the top of the display.</li> </ul>
No picture/No picture from AV terminal.	<ul style="list-style-type: none"> <li>• Check the brightness setting of the display.</li> <li>• Lamp may have malfunction.</li> <li>• Make sure a cable with no VIDEO input signal is connected to the S-VIDEO INPUT terminal.</li> </ul>
Picture is displayed, but no sound from the speakers.	<ul style="list-style-type: none"> <li>• Check the sound setting.</li> <li>• Make sure the sound is not muted.</li> <li>• Make sure the connectors of the optional speaker system are securely inserted.</li> <li>• Make sure the setting of AV OUTPUT terminal</li> </ul>
Picture is too light	<ul style="list-style-type: none"> <li>• Make sure COLOR and CONTRAST settings.</li> </ul>
Picture is too dark.	<ul style="list-style-type: none"> <li>• Make sure BRIGHTNESS setting is not set too low.</li> <li>• Check to see if BRIGHTNESS setting</li> <li>• Lamp may have malfunction.</li> </ul>
Remote control does not work.	<ul style="list-style-type: none"> <li>• Change the batteries.</li> <li>• Make sure the infrared transmitter window is not receiving strong light such as light from fluorescent lamps.</li> </ul>
No picture from AV OUT terminal.	<ul style="list-style-type: none"> <li>• Make sure AV INPUT is not set.</li> <li>• Make sure the input source other than AV</li> </ul>
The picture is not sharp. The picture moves.	<ul style="list-style-type: none"> <li>• The reception may be weak.</li> <li>• The state of the broadcast may also be bad.</li> <li>• Make sure the antenna is facing the right direction.</li> <li>• Make sure the outside antenna is not disconnected.</li> </ul>
The picture is doubled or tripled.	<ul style="list-style-type: none"> <li>• Make sure the antenna is facing the right direction.</li> <li>• There may be reflected electric waves from mountains or buildings.</li> </ul>
The picture is spotted.	<ul style="list-style-type: none"> <li>• There may be interference from automobiles, trains, high voltage lines, neon lights, etc.</li> <li>• There may be interference between the antenna cable and power cable. Try positioning them further apart.</li> </ul>
There are stripes on the screen or colors fade.	<ul style="list-style-type: none"> <li>• Is the unit receiving interference from other devices? Transmission antennas of radio broadcasting stations and transmission antennas of amateur radios and cellular phones may also cause interference.</li> <li>• Use the unit as far apart as possible from devices that may cause possible interference.</li> </ul>

# LIMITED WARRANTY

---