



Main

Range of product	Harmony XVU
Product or component type	Modular tower light
Accessory / separate part type	Mounting plate
Accessory / separate part category	Mounting and fixing accessory
Component name	XVU
Mounting diameter	60 mm

Complementary

Pin number	2
Mounting support	Direct mounting
Product compatibility	Top : AC body Top : DC body Top : swivel mounting support
Material	ABS (acrylonitrile butadiene-styrene) PC (polycarbonate) PBT (polybutylene terephthalate) V-0 flame retardant conforming to UL 94
Housing colour	Black
Connections - terminals	Push-in
[Us] rated supply voltage	110...240 V AC 24 V AC/DC
Length	17 mm
Product weight	0.06 kg

Environment

ambient air temperature for storage	-40...70 °C
ambient air temperature for operation	-25...50 °C
IP degree of protection	IP65
product certifications	CE CSA UL UL

Offer Sustainability

Sustainable offer status	Green Premium product
RoHS (date code: YYWW)	Compliant - since 1449 - Schneider Electric declaration of conformity
REACH	Reference not containing SVHC above the threshold
Product environmental profile	Available
Product end of life instructions	Available

Contractual warranty

Warranty period	18 months
-----------------	-----------

Dimensions Drawings

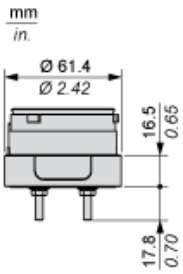

Modular Tower Lights Mounting

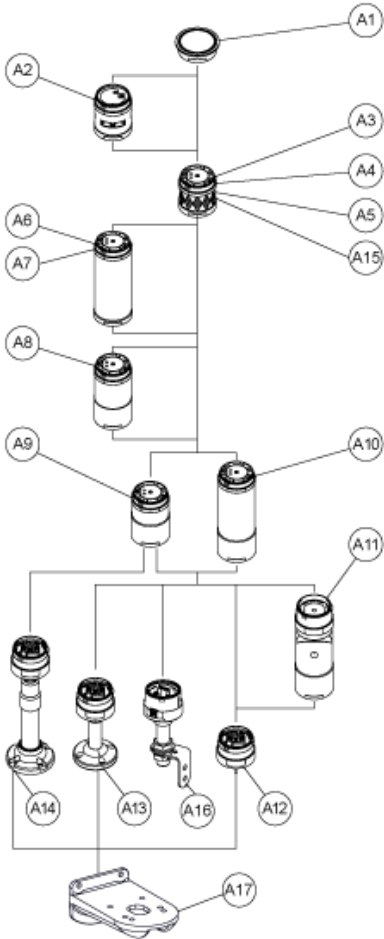

Drawing	Part number	Part name
A1	-	Top cover
	-	Top cover (Silver)
A2	XVUC9S	Buzzer unit
	XVUC9SQ	Buzzer unit (Silver)
A3	XVUC23	Green LED unit
	XVUC24	Red LED unit
	XVUC25	Orange LED unit
	XVUC26	Blue LED unit
	XVUC27	White LED unit
	XVUC28	Yellow LED unit
A4	XVUC29	Multi-LED unit
A5	XVUC29P	Multi-LED unit, Pulse signal

A6	XVUC9V	Sound unit
A7	XVUC9VP	Sound unit, Pulse signal
A8	XVUC020	Extender
	XVUC020Q	Extender (Silver)
A9	XVUC21B	DC body
	XVUC21BQ	DC body (Silver)
A10	XVUC21M	AC body NPN
	XVUC21MP	AC body PNP
	XVUC21MQP	AC body PNP (Silver)
A11	XVUZ06	Flexible option
A12	XVUZ01	Fixing Unit - Direct mounting (3 pins)
	XVUZ01Q	Fixing Unit - Direct mounting (Silver,3 pins)
	XVUZ03	Fixing Unit - Direct mounting (2 pins)
	XVUZ04	Fixing Unit - Direct mounting (4 pins)
A13	XVUZ02	Fixing Unit - Plate with Pole (100 mm)
	XVUZ02Q	Fixing Unit - Plate with Pole (100 mm, Silver)
	XVUZ400	Fixing Unit - Plate with Pole (400 mm)
	XVUZ800	Fixing Unit - Plate with Pole (800 mm)
A14	XVUZ05	Fixing Unit - Plate with adjustment pole (100-385 mm)
A15	XVUC43	Green LED unit, Flash
	XVUC44	Red LED unit, Flash
	XVUC45	Orange LED unit, Flash
	XVUC46	Blue LED unit, Flash
	XVUC47	White LED unit, Flash
	XVUC48	Yellow LED unit, Flash
A16	XVUZ100T	Fixing Unit - Metal bracket with pole (100 mm)
	XVUZ250T	Fixing Unit - Metal bracket with pole(250 mm)
	XVUZ400T	Fixing Unit - Metal bracket with pole (400 mm)
A17	XVUZ12	Fixing plate for use on vertical support - black

Modular Tower Lights Mounting

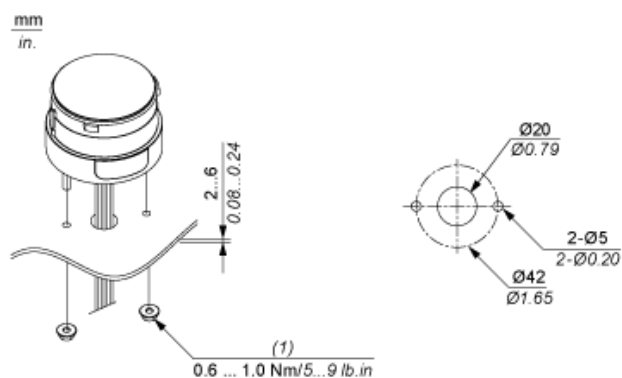

(1) M4 Nut x 3 (attached)

Flexible Option Mounting

Recommended Mounting

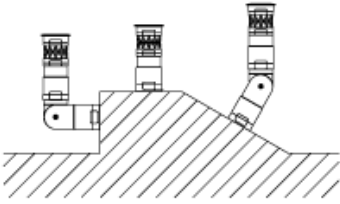

No Recommended Mounting

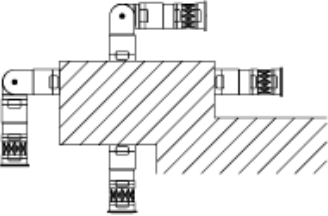

Illuminated Units, Multi-LED and Audible Units Wiring

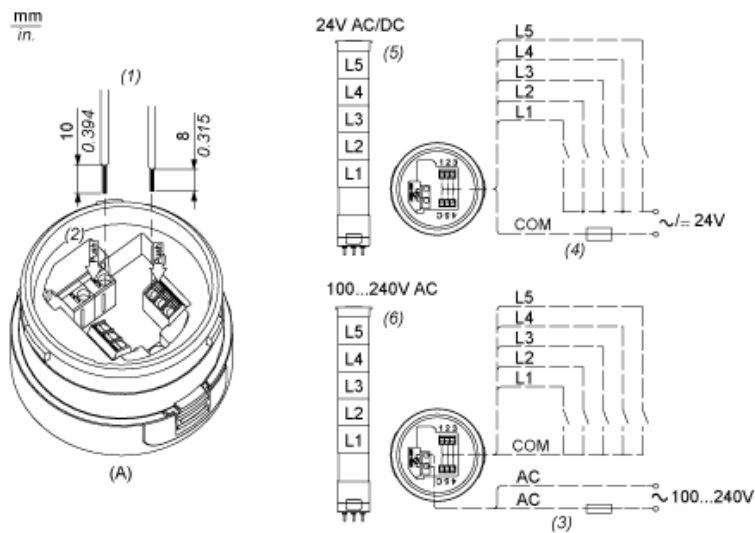

- (A) Fixing Unit
- (1) Dimensions of Wiring size
- (2) Push-in Wire Connectors
- (3) Fuse : 2A ,250V
- (4) Fuse : 0.5A ,125V
- (5) Modular Tower Lights 24V AC/DC
- (6) Modular Tower Lights 100...240V AC
- L1 Illuminated LED Units
- to
- L5 :