

**PN4391
PN4392
PN4393**

**MMBF4391
MMBF4392
MMBF4393**

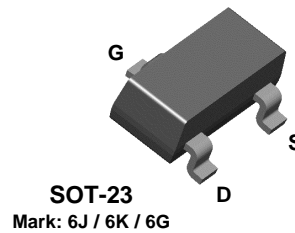
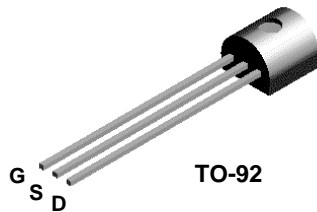

NOTE: Source & Drain
are interchangeable

N-Channel Switch

This device is designed for low level analog switching, sample and hold circuits and chopper stabilized amplifiers. Sourced from Process 51. See J111 for characteristics.

Absolute Maximum Ratings* TA = 25°C unless otherwise noted

Symbol	Parameter	Value	Units
V_{DG}	Drain-Gate Voltage	30	V
V_{GS}	Gate-Source Voltage	- 30	V
I_{GF}	Forward Gate Current	50	mA
T_J, T_{stg}	Operating and Storage Junction Temperature Range	-55 to +150	°C

*These ratings are limiting values above which the serviceability of any semiconductor device may be impaired.

NOTES:

- 1) These ratings are based on a maximum junction temperature of 150 degrees C.
- 2) These are steady state limits. The factory should be consulted on applications involving pulsed or low duty cycle operations

Thermal Characteristics TA = 25°C unless otherwise noted

Symbol	Characteristic	Max		Units
		PN4391-4393	*MMBF4391-4393	
P_D	Total Device Dissipation Derate above 25°C	625	350	mW
		5.0	2.8	mW/°C
$R_{\theta JC}$	Thermal Resistance, Junction to Case	125		°C/W
$R_{\theta JA}$	Thermal Resistance, Junction to Ambient	357	556	°C/W

*Device mounted on FR-4 PCB 1.6" X 1.6" X 0.06."

N-Channel Switch

(continued)

Electrical Characteristics

TA = 25°C unless otherwise noted

Symbol	Parameter	Test Conditions	Min	Max	Units	
OFF CHARACTERISTICS						
V _{(BR)GSS}	Gate-Source Breakdown Voltage	I _G = 1.0 μA, V _{DS} = 0	- 30		V	
I _{GSS}	Gate Reverse Current	V _{GS} = - 15 V, V _{DS} = 0 V _{GS} = - 15 V, V _{DS} = 0, T _A = 150°C		- 1.0 - 0.2	nA μA	
V _{GS(off)}	Gate-Source Cutoff Voltage	V _{DS} = 20 V, I _D = 1.0 nA	4391 4392 4393	- 4.0 - 2.0 - 3.0	V V V	
V _{GS(f)}	Gate-Source Forward Voltage	I _G = 1.0 mA, V _{DS} = 0		1.0	V	
I _{D(off)}	Drain Cutoff Leakage Current	V _{DS} = 20 V, V _{GS} = - 12 V V _{DS} = 20 V, V _{GS} = - 7.0 V V _{DS} = 20 V, V _{GS} = - 5.0 V V _{DS} = 20 V, V _{GS} = - 12 V, T _A = 150°C V _{DS} = 20 V, V _{GS} = - 7.0 V, T _A = 150°C V _{DS} = 20 V, V _{GS} = - 5.0 V, T _A = 150°C	4391 4392 4393 4391 4392 4393	0.1 0.1 0.1 0.2 0.2 0.2	nA nA nA μA μA μA	
ON CHARACTERISTICS						
I _{DSS}	Zero-Gate Voltage Drain Current*	V _{DS} = 20 V, V _{GS} = 0	4391 4392 4393	50 25 5.0	150 75 30	mA mA mA
V _{DS(on)}	Drain-Source On Voltage	I _D = 12 mA, V _{GS} = 0 I _D = 6.0 mA, V _{GS} = 0 I _D = 3.0 mA, V _{GS} = 0	4391 4392 4393		0.4 0.4 0.4	V V V
r _{DS(on)}	Drain-Source On Resistance	I _D = 1.0 mA, V _{GS} = 0	4391 4392 4393		30 60 100	Ω Ω Ω
SMALL-SIGNAL CHARACTERISTICS						
r _{DS(on)}	Drain-Source On Resistance	V _{DS} = V _{GS} = 0, f = 1.0 kHz	4391 4392 4393		30 60 100	Ω Ω Ω
C _{iss}	Input Capacitance	V _{DS} = 20, V _{GS} = 0, f = 1.0 MHz			14	pF
C _{rss}	Reverse Transfer Capacitance	V _{GS} = - 12 V, f = 1.0 MHz V _{GS} = - 7.0 V, f = 1.0 MHz V _{GS} = - 5.0 V, f = 1.0 MHz	4391 4392 4393		3.5 3.5 3.5	pF pF pF
SWITCHING CHARACTERISTICS						
t _r	Rise Time	I _{D(on)} = 12 mA I _{D(on)} = 6.0 mA I _{D(on)} = 3.0 mA	4391 4392 4393		5.0 5.0 5.0	ns ns ns
t _f	Fall Time	V _{GS(off)} = 12 V V _{GS(off)} = 6.0 V V _{GS(off)} = 3.0 V	4391 4392 4393		15 20 30	ns ns ns
t _{on}	Turn-On Time	I _{D(on)} = 12 mA I _{D(on)} = 6.0 mA I _{D(on)} = 3.0 mA	4391 4392 4393		15 15 15	ns ns ns
t _{off}	Turn-Off Time	V _{GS(off)} = 12 V V _{GS(off)} = 6.0 V V _{GS(off)} = 3.0 V	4391 4392 4393		20 35 50	ns ns ns

*Pulse Test: Pulse Width ≤ 300 μs, Duty Cycle ≤ 1.0%

PN4391 / 4392 / 4393 / MMBF4391 / 4392 / 4393

TO-92 Tape and Reel Data



TO-92 Packaging Configuration: Figure 1.0

FSCINT Label sample



F63TNR Label sample

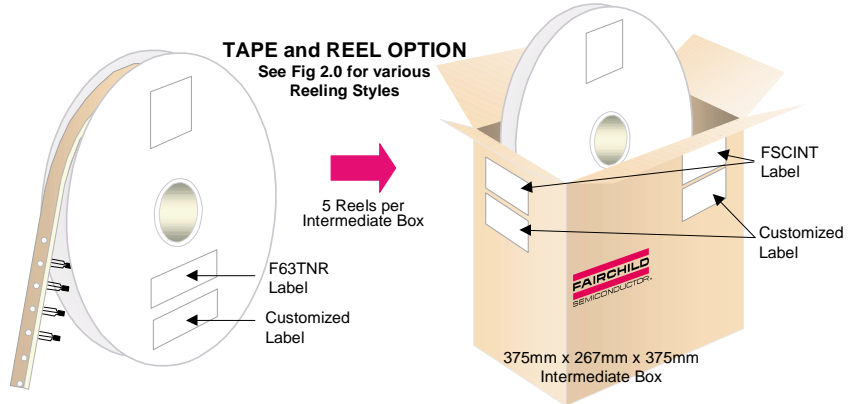

TO-92 TNR/AMMO PACKING INFORMATION

Packing	Style	Quantity	EOL code
Reel	A	2,000	D26Z
	E	2,000	D27Z
Ammo	M	2,000	D74Z
	P	2,000	D75Z

Unit weight = 0.22 gm
 Reel weight with components = 1.04 kg
 Ammo weight with components = 1.02 kg
 Max quantity per intermediate box = 10,000 units

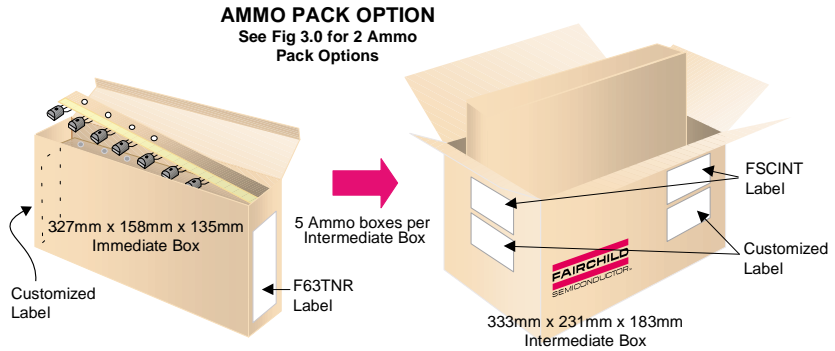

(TO-92) BULK PACKING INFORMATION

EOL CODE	DESCRIPTION	LEADCLIP DIMENSION	QUANTITY
J18Z	TO-18 OPTION STD	NO LEAD CLIP	2.0 K / BOX
J05Z	TO-5 OPTION STD	NO LEAD CLIP	1.5 K / BOX
NO EOL CODE	TO-92 STANDARD STRAIGHT FOR: PKG 92, 94 (NON PROELECTRON SERIES), 96	NO LEADCLIP	2.0 K / BOX
L34Z	TO-92 STANDARD STRAIGHT FOR: PKG 94 (PROELECTRON SERIES BCXXX, BFXXX, BSRXXX), 97, 98	NO LEADCLIP	2.0 K / BOX

BULK OPTION

See Bulk Packing Information table

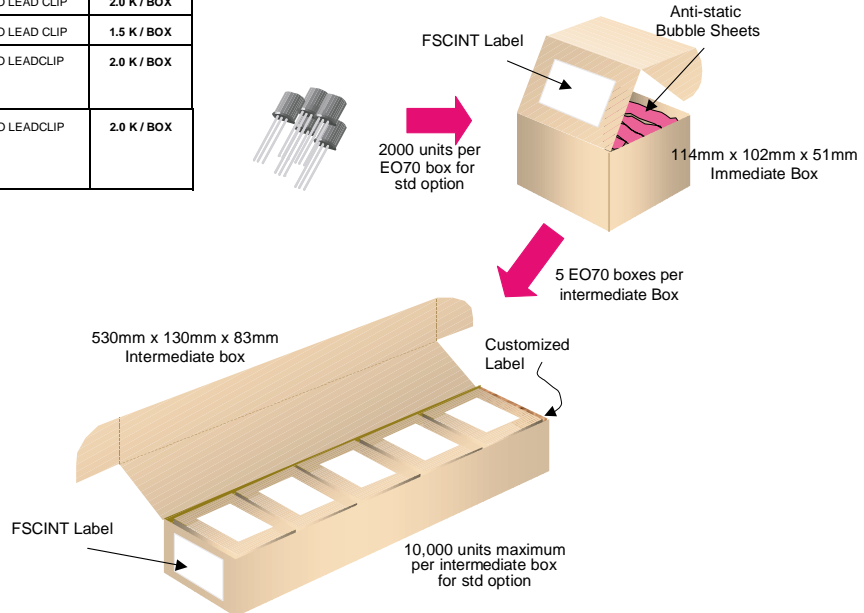

TO-92 Tape and Reel Data, continued

TO-92 Reeling Style

Configuration: Figure 2.0

Machine Option "A" (H)

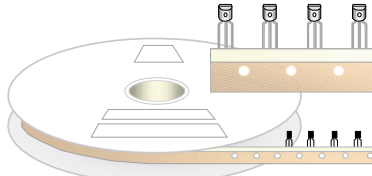

Style "A", D26Z, D70Z (s/h)

Machine Option "E" (J)

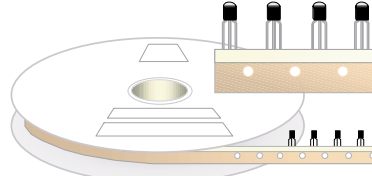

Style "E", D27Z, D71Z (s/h)

TO-92 Radial Ammo Packaging

Configuration: Figure 3.0

FIRST WIRE OFF IS COLLECTOR
ADHESIVE TAPE IS ON THE TOP SIDE
FLAT OF TRANSISTOR IS ON TOP

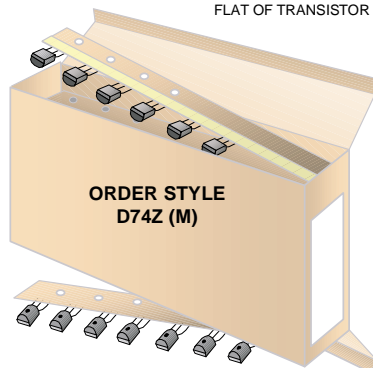

ORDER STYLE
D74Z (M)

FIRST WIRE OFF IS EMITTER (ON PKG. 92)
ADHESIVE TAPE IS ON BOTTOM SIDE
FLAT OF TRANSISTOR IS ON BOTTOM

FIRST WIRE OFF IS EMITTER
ADHESIVE TAPE IS ON THE TOP SIDE
FLAT OF TRANSISTOR IS ON BOTTOM

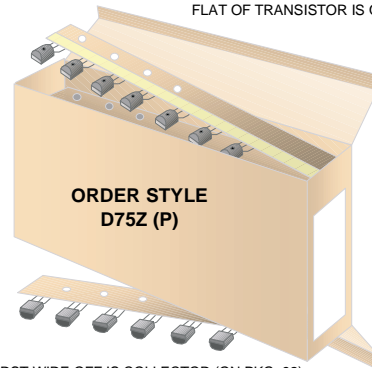

ORDER STYLE
D75Z (P)

FIRST WIRE OFF IS COLLECTOR (ON PKG. 92)
ADHESIVE TAPE IS ON BOTTOM SIDE
FLAT OF TRANSISTOR IS ON TOP

TO-92 Tape and Reel Data, continued

**TO-92 Tape and Reel Taping
Dimension Configuration: Figure 4.0**

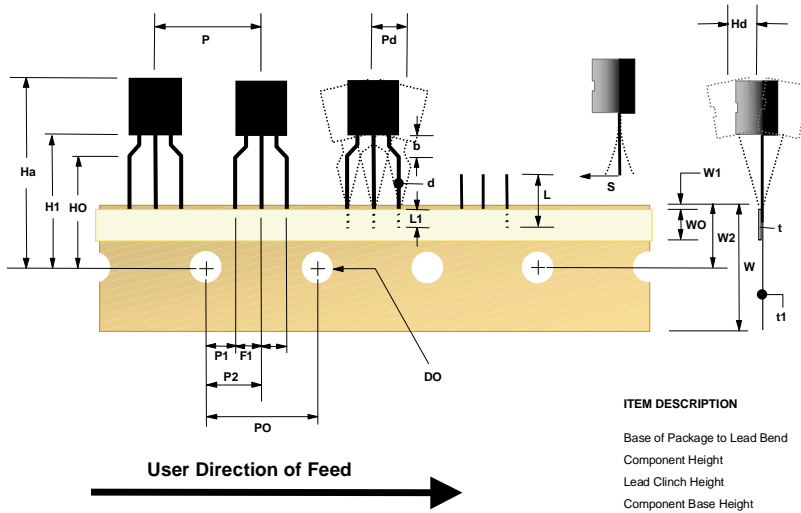

ITEM DESCRIPTION	SYMBOL	DIMENSION
Base of Package to Lead Bend	b	0.098 (max)
Component Height	Ha	0.928 (+/- 0.025)
Lead Clinch Height	HO	0.630 (+/- 0.020)
Component Base Height	H1	0.748 (+/- 0.020)
Component Alignment (side/side)	Pd	0.040 (max)
Component Alignment (front/back)	Hd	0.031 (max)
Component Pitch	P	0.500 (+/- 0.020)
Feed Hole Pitch	PO	0.500 (+/- 0.008)
Hole Center to First Lead	P1	0.150 (+0.009, -0.010)
Hole Center to Component Center	P2	0.247 (+/- 0.007)
Lead Spread	F1/F2	0.104 (+/- 0.010)
Lead Thickness	d	0.018 (+0.002, -0.003)
Cut Lead Length	L	0.429 (max)
Taped Lead Length	L1	0.209 (+0.051, -0.052)
Taped Lead Thickness	t	0.032 (+/- 0.006)
Carrier Tape Thickness	t1	0.021 (+/- 0.006)
Carrier Tape Width	W	0.708 (+0.020, -0.019)
Hold - down Tape Width	WO	0.236 (+/- 0.012)
Hold - down Tape position	W1	0.035 (max)
Feed Hole Position	W2	0.360 (+/- 0.025)
Sprocket Hole Diameter	DO	0.157 (+0.008, -0.007)
Lead Spring Out	S	0.004 (max)

Note : All dimensions are in inches.

**TO-92 Reel
Configuration: Figure 5.0**

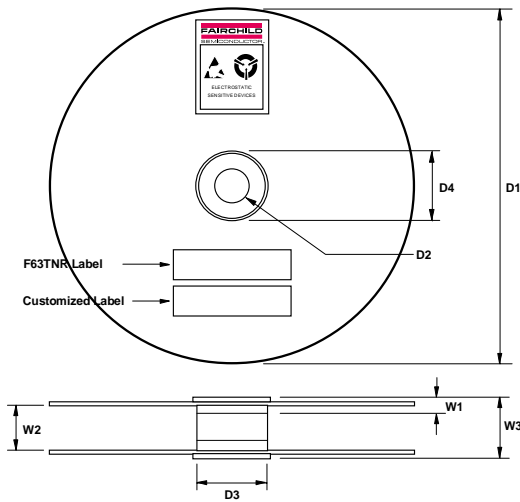

ITEM DESCRIPTION	SYMBOL	MINIMUM	MAXIMUM
Reel Diameter	D1	13.975	14.025
Arbor Hole Diameter (Standard)	D2	1.160	1.200
(Small Hole)	D2	0.650	0.700
Core Diameter	D3	3.100	3.300
Hub Recess Inner Diameter	D4	2.700	3.100
Hub Recess Depth	W1	0.370	0.570
Flange to Flange Inner Width	W2	1.630	1.690
Hub to Hub Center Width	W3		2.090

Note: All dimensions are in inches

TO-92 Package Dimensions



TO-92 (FS PKG Code 92, 94, 96)

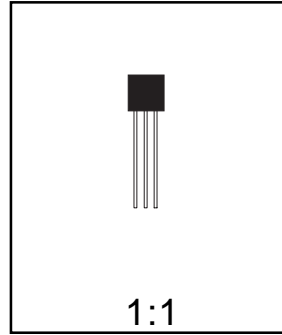
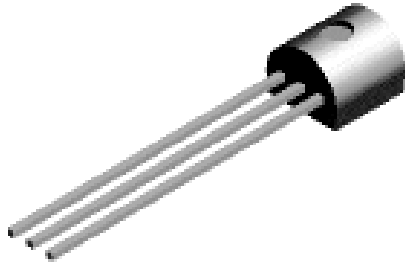

Scale 1:1 on letter size paper

Dimensions shown below are in:
inches [millimeters]

Part Weight per unit (gram): 0.1977

TO-92 (92,94,96)

PIN	92		94		96	
	B	F	B	F	B	F
1	E	D	E	D	B	S
2	B	S	C	G	E	D
3	C	G	B	S	C	G

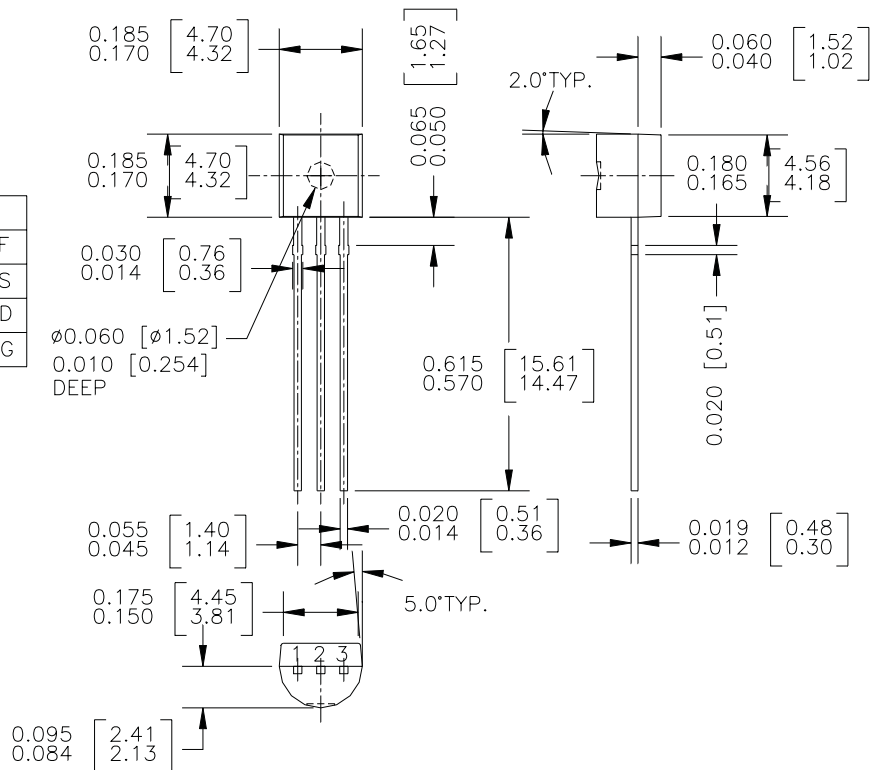

SOT-23 Tape and Reel Data



SOT-23 Packaging Configuration: Figure 10

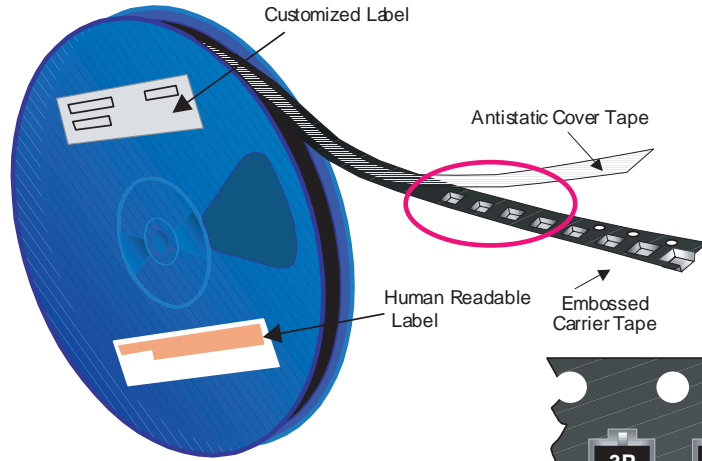

Packaging Description:

SOT-23 parts are shipped in tape. The carrier tape is made from a dissipative (carbon filled) polycarbonate resin. The cover tape is a multilayer film (Heat Activated Adhesive in nature) primarily composed of polyester film, adhesive layer, sealant, and anti-static sprayed agent. These reeled parts in standard option are shipped with 3,000 units per 7" or 177mm diameter reel. The reels are dark blue in color and is made of polystyrene plastic (anti-static coated). Other option comes in 10,000 units per 13" or 330mm diameter reel. This and some other options are described in the Packaging Information table.

These full reels are individually labeled and placed inside a standard intermediate made of recyclable corrugated brown paper with a Fairchild logo printing. One pizza box contains eight reels maximum. And these intermediate boxes are placed inside a labeled shipping box which comes in different sizes depending on the number of parts shipped.

SOT-23 Packaging Information		
Packaging Option	Standard (no flow code)	D87Z
Packaging type	TNR	TNR
Qty per Reel/Tube/Bag	3,000	10,000
Reel Size	7" Dia	13"
Box Dimension (mm)	187x107x183	343x343x64
Max qty per Box	24,000	30,000
Weight per unit (gm)	0.0082	0.0082
Weight per Reel (kg)	0.1175	0.4006
Note/Comments		

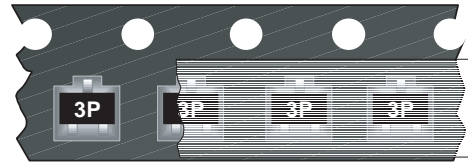

SOT-23 Unit Orientation

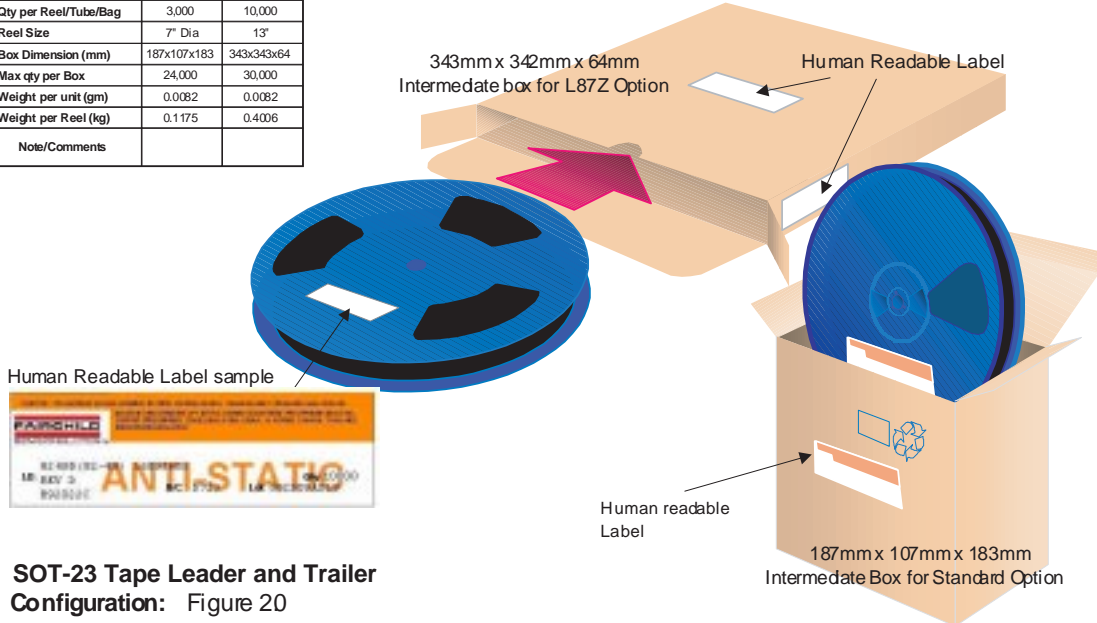

Human Readable Label sample



SOT-23 Tape Leader and Trailer Configuration: Figure 20

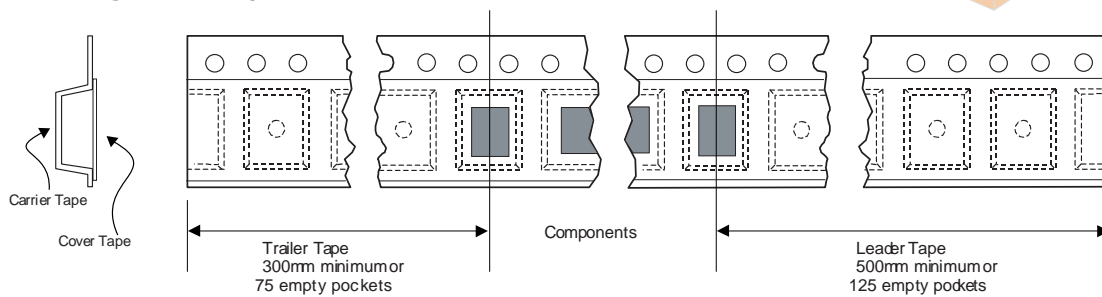

SOT-23 Tape and Reel Data, continued

SOT-23 Embossed Carrier Tape Configuration: Figure 3.0

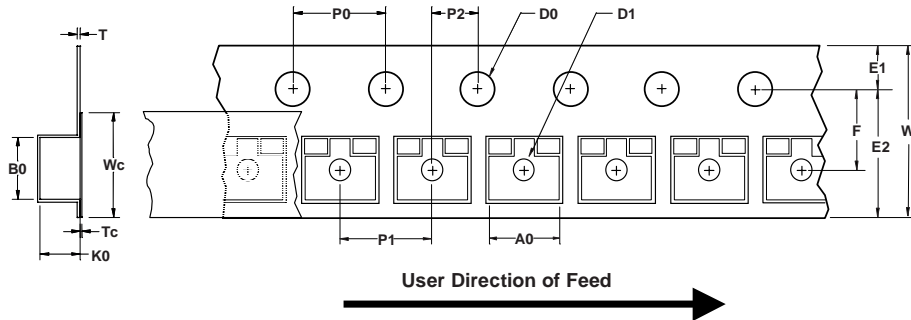

Dimensions are in millimeter														
Pkg type	A0	B0	W	D0	D1	E1	E2	F	P1	P0	K0	T	Wc	Tc
SOT-23 (8mm)	3.15 ±0.10	2.77 ±0.10	8.0 ±0.3	1.55 ±0.05	1.125 ±0.125	1.75 ±0.10	6.25 min	3.50 ±0.05	4.0 ±0.1	4.0 ±0.1	1.30 ±0.10	0.228 ±0.013	5.2 ±0.3	0.06 ±0.02

Notes: A0, B0, and K0 dimensions are determined with respect to the EIA/Jedec RS-481 rotational and lateral movement requirements (see sketches A, B, and C).

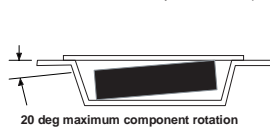

Sketch A (Side or Front Sectional View)
Component Rotation

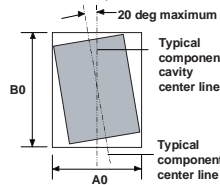

Sketch B (Top View)
Component Rotation

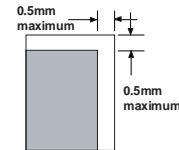

Sketch C (Top View)
Component lateral movement

SOT-23 Reel Configuration: Figure 4.0

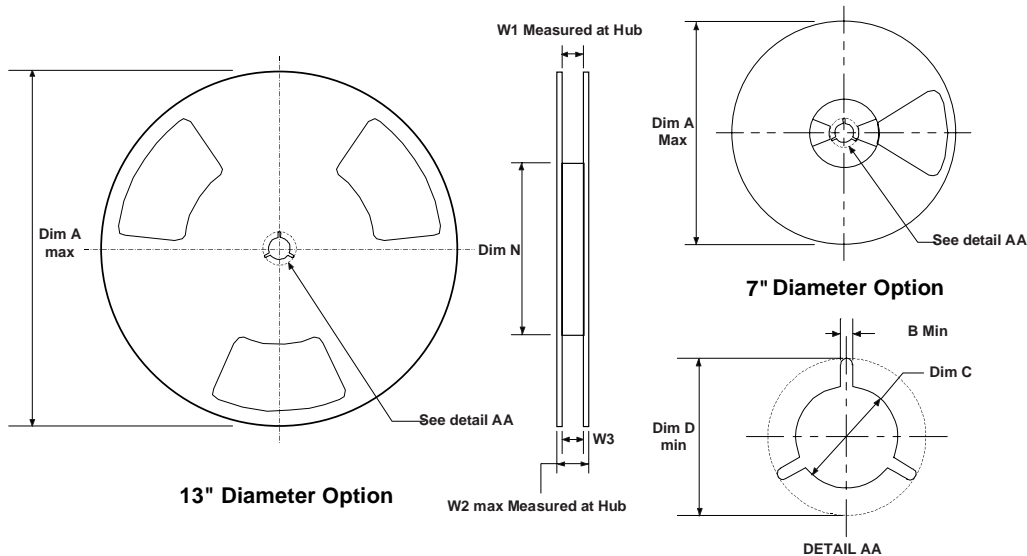

Dimensions are in inches and millimeters									
Tape Size	Reel Option	Dim A	Dim B	Dim C	Dim D	Dim N	Dim W1	Dim W2	Dim W3 (LSL-USL)
8mm	7" Dia	7.00 177.8	0.059 1.5	512 +0.020/-0.008 13 +0.5/-0.2	0.795 20.2	2.165 55	0.331 +0.059/-0.000 8.4 +1.5/0	0.567 14.4	0.311 -0.429 7.9 - 10.9
8mm	13" Dia	13.00 330	0.059 1.5	512 +0.020/-0.008 13 +0.5/-0.2	0.795 20.2	4.00 100	0.331 +0.059/-0.000 8.4 +1.5/0	0.567 14.4	0.311 -0.429 7.9 - 10.9

SOT-23 Package Dimensions



SOT-23 (FS PKG Code 49)

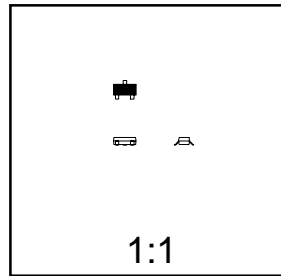
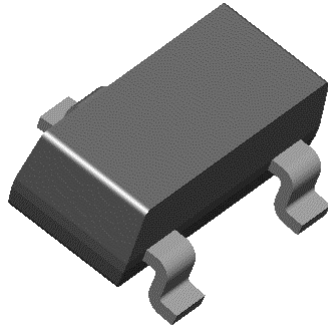

Scale 1:1 on letter size paper

Dimensions shown below are in:
inches [millimeters]

Part Weight per unit (gram): 0.0082

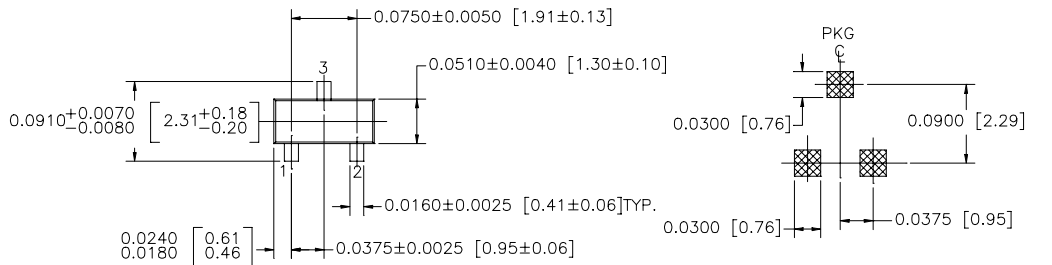

LAND PATTERN RECOMMENDATION

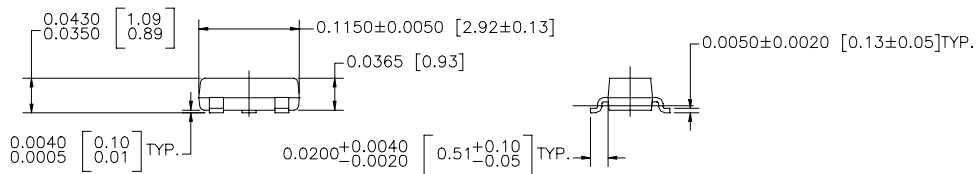

CONTROLLING DIMENSION IS INCH
VALUES IN [] ARE MILLIMETERS

SOT 23, 3 LEADS LOW PROFILE

NOTE : UNLESS OTHERWISE SPECIFIED

- STANDARD LEAD FINISH 150 MICRONS / 3.81 MICROMETERS
MINIMUM TIN / LEAD (SOLDER) ON ALLOY 42
- REFERENCE JEDEC REGISTRATION TO-236, VARIATION AB, ISSUE G, DATED JUL 1993

TRADEMARKS

The following are registered and unregistered trademarks Fairchild Semiconductor owns or is authorized to use and is not intended to be an exhaustive list of all such trademarks.

ACEx™	FASTr™	PowerTrench®	SyncFET™
Bottomless™	GlobalOptoisolator™	QFET™	TinyLogic™
CoolFET™	GTO™	QS™	UHC™
CROSSVOLT™	HiSeC™	QT Optoelectronics™	VCX™
DOME™	ISOPLANAR™	Quiet Series™	
E ² CMOS™	MICROWIRE™	SILENT SWITCHER®	
EnSigna™	OPTOLOGIC™	SMART START™	
FACT™	OPTOPLANAR™	SuperSOT™-3	
FACT Quiet Series™	PACMAN™	SuperSOT™-6	
FAST®	POP™	SuperSOT™-8	

DISCLAIMER

FAIRCHILD SEMICONDUCTOR RESERVES THE RIGHT TO MAKE CHANGES WITHOUT FURTHER NOTICE TO ANY PRODUCTS HEREIN TO IMPROVE RELIABILITY, FUNCTION OR DESIGN. FAIRCHILD DOES NOT ASSUME ANY LIABILITY ARISING OUT OF THE APPLICATION OR USE OF ANY PRODUCT OR CIRCUIT DESCRIBED HEREIN; NEITHER DOES IT CONVEY ANY LICENSE UNDER ITS PATENT RIGHTS, NOR THE RIGHTS OF OTHERS.

LIFE SUPPORT POLICY

FAIRCHILD'S PRODUCTS ARE NOT AUTHORIZED FOR USE AS CRITICAL COMPONENTS IN LIFE SUPPORT DEVICES OR SYSTEMS WITHOUT THE EXPRESS WRITTEN APPROVAL OF FAIRCHILD SEMICONDUCTOR CORPORATION. As used herein:

1. Life support devices or systems are devices or systems which, (a) are intended for surgical implant into the body, or (b) support or sustain life, or (c) whose failure to perform when properly used in accordance with instructions for use provided in the labeling, can be reasonably expected to result in significant injury to the user.
2. A critical component is any component of a life support device or system whose failure to perform can be reasonably expected to cause the failure of the life support device or system, or to affect its safety or effectiveness.

PRODUCT STATUS DEFINITIONS

Definition of Terms

Datasheet Identification	Product Status	Definition
Advance Information	Formative or In Design	This datasheet contains the design specifications for product development. Specifications may change in any manner without notice.
Preliminary	First Production	This datasheet contains preliminary data, and supplementary data will be published at a later date. Fairchild Semiconductor reserves the right to make changes at any time without notice in order to improve design.
No Identification Needed	Full Production	This datasheet contains final specifications. Fairchild Semiconductor reserves the right to make changes at any time without notice in order to improve design.
Obsolete	Not In Production	This datasheet contains specifications on a product that has been discontinued by Fairchild semiconductor. The datasheet is printed for reference information only.