





















Datasheet

Blue Panel Mount Female 2P+E Straight Industrial Power Socket Rated At 16A,200 → 250 V

RS Stock number [464-1627](#)





Straight 75

Description		Colour	Pack qty.	Cat. no.
2P+⊕	4h 50/60Hz 100-130V		10/100	• 422.1660
	6h 50/60Hz 200-250V		10/100	• 422.1663
	9h 50/60Hz 380-415V		10/100	• 422.1668
16A 3P+⊕	4h 50/60Hz 100-130V		10/100	• 422.1661
	9h 50/60Hz 200-250V		10/100	• 422.1664
	6h 50/60Hz 380-415V		10/100	• 422.1666
3P+N+⊕	3h 50-60Hz 380/440V		10/100	• 422.16664
	4h 50/60Hz 100-130V		10/100	• 422.1662
	9h 50/60Hz 208-250V		10/100	• 422.1665
2P+⊕	6h 50/60Hz 346-415V		10/100	• 422.1667
	4h 50/60Hz 100-130V		10/50	• 422.3260
	6h 50/60Hz 200-250V		10/50	• 422.3263
32A 3P+⊕	9h 50/60Hz 380-415V		10/50	• 422.3268
	4h 50/60Hz 100-130V		10/50	• 422.3261
	9h 50/60Hz 200-250V		10/50	• 422.3264
3P+N+⊕	6h 50/60Hz 380-415V		10/50	• 422.3266
	3h 50-60Hz 380/440V		10/50	• 422.32664
	4h 50/60Hz 100-130V		10/50	• 422.3262
3P+N+⊕	9h 50/60Hz 208-250V		10/50	• 422.3265
	6h 50/60Hz 346-415V		10/50	• 422.3267



Straight 62 (*)

Description		Colour	Pack qty.	Cat. no.
16A 2P+⊕	4h 50/60Hz 100-130V		10/100	422.1660/R
	6h 50/60Hz 200-250V		10/100	422.1663/R
	9h 50/60Hz 380-415V		10/100	422.1668/R

422.

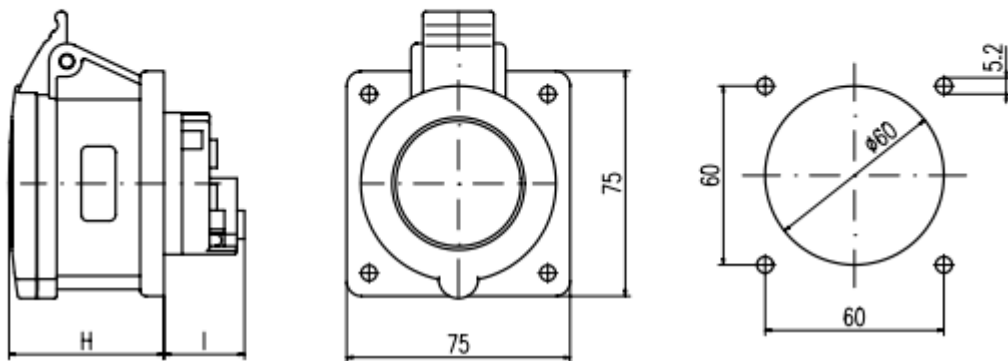

		I	H
16A	2P+ $\frac{1}{2}$	27	51
	3P+ $\frac{1}{2}$	27	51
	3P+N+ $\frac{1}{2}$	27	52
32A	2P+ $\frac{1}{2}$	42	62
	3P+ $\frac{1}{2}$	42	62
	3P+N+ $\frac{1}{2}$	42	63