

order number: J01016A0005

TNC Attenuator; m-f; 6 dB; 2 W; 10 GHz

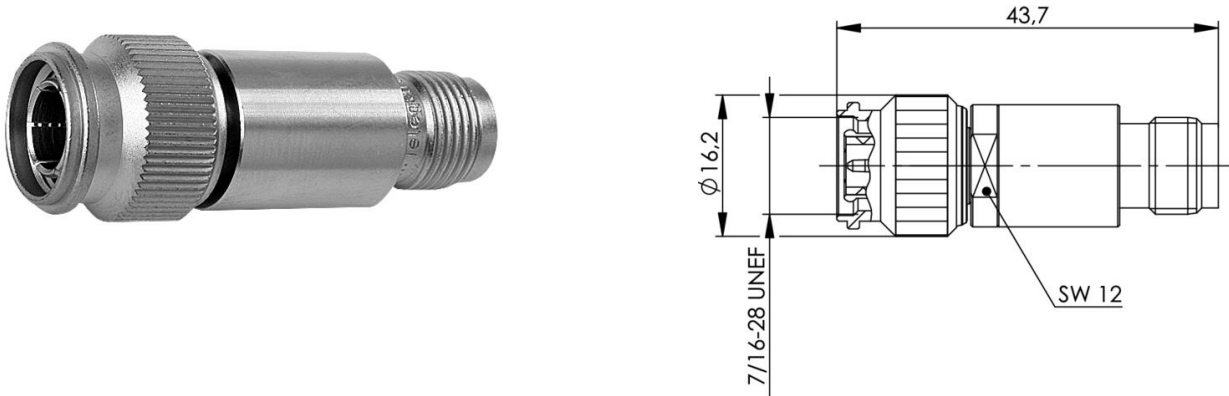

Technical Attributes	
Attenuation	6 dB
Max. Frequency	10 GHz
Max. Power	2 W
Return Loss	27 dB/4 GHz; 15 dB/10 GHz
Remarks	m-f

## Product description

The TNC series is a commonly used coax connector. The same size as BNC connectors, but with a threaded coupling mechanism, this connector can be used up to 11 GHz. Both 50  $\Omega$  and 75  $\Omega$  impedances are available. Connector styles are available for flexible, conformable and semi-rigid cable types. Versions of the TNC connector are available for mounting to printed circuit boards using both through-hole soldered and through-hole press-fit techniques. Both crimp and clamp cable termination processes are used for this series. Applications for these connectors range from signal and data to video transmission where vibration resistance is required. TNC's are a low-cost high-frequency solution for coax connections.

Mating face sealing for TNC connectors between plug and jack (mated) according to IP 68. The classifications are general statements for the relevant series. Individual connectors may deviate from the values shown. If in doubt, please consult our engineers.

Mechanical Characteristics	
Recommended coupling torque	0.46 - 0.69 Nm
Durability (mating cycles)	$\geq 500$
	CuBe2; CuNi1Pb1P(C97)

Material: spring contacts	
Material: outer conductor	CuZn39Pb3
Material: other metal parts	CuZn39Pb3
Material: gaskets	Silicone
Material: insulators	PTFE; PE
Finish: Inner conductor	Cu1Ni2Au0.8
Finish: Outer conductor	Cu2Ni5
Finish: Other metal parts	Cu2Ni5

Climatic Characteristics	
Climatic category acc. to IEC 60068 - 1	
Types with PTFE insulator	40/155/21
Types with PE insulator	40/75/21

Electrical Characteristics	
Contact resistance inner conductor	$\leq 10 \text{ m}\Omega$
Contact resistance outer conductor	$\leq 2.5 \text{ m}\Omega$
Insulation resistance	$\geq 5 \text{ GHz}$
Voltage proof	1.5 kV <sub>eff</sub> /50 Hz
Impedance	50 $\Omega$ /(75 $\Omega$ )
Return loss: Straight style (valid for 50 $\Omega$ only)	$\geq 17.7 \text{ dB}/11 \text{ GHz}$
Return loss: Angle style (valid for 50 $\Omega$ only)	$\geq 16.5 \text{ dB}/11 \text{ GHz}$
Working voltage	$\leq 500 \text{ V}_{\text{eff}}/50 \text{ Hz}$
Frequency range up to (valid for 50 $\Omega$ only)	11 GHz

Standards	
IEC 60 169-17	

## Note

Combination connectors and cable clamps can be utilised to create a further number of TNC connector variations.