

Wall mounted socket - Part no. 7605

- screw terminals
- for horizontal installation
- switched
- mechanical DUO-interlock
- sockets can be padlocked

Protection type	IP 44
Ampere	16 A
Poles	4p
Voltage	400
Hertz	50-60Hz
Earth position	6h
Contact	standard
Connection technology	Screw terminals

Std. Pack. 1 Qty.

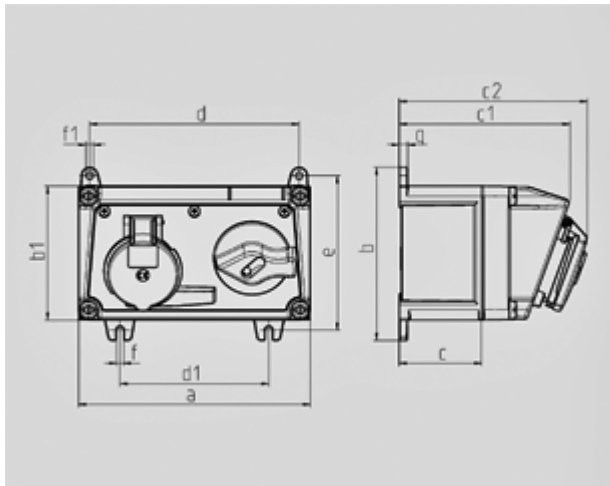

Drawing	Amp.	16			32		
		3	4	5	3	4	5
1 MB 550	Poles						
Dim. in mm	a	225	225	225	225	225	225
	b	168	168	168	168	168	168
	b1	130	130	130	130	130	130
	c	80	80	80	80	80	80
	c1	166	166	166	166	166	166
	c2	182	183	183	193	193	193
	d	204	204	204	204	204	204
	d1	145	145	145	145	145	145
	e	150	150	150	150	150	150
	f	7	7	7	7	7	7
	f1	Ø7	Ø7	Ø7	Ø7	Ø7	Ø7
	g	8	8	8	8	8	8