

CONFIGURATION	PART NUMBER	LENGTH
Straight Extension, 8 Pos	MB1JJN0800	NA

DIMENSIONS

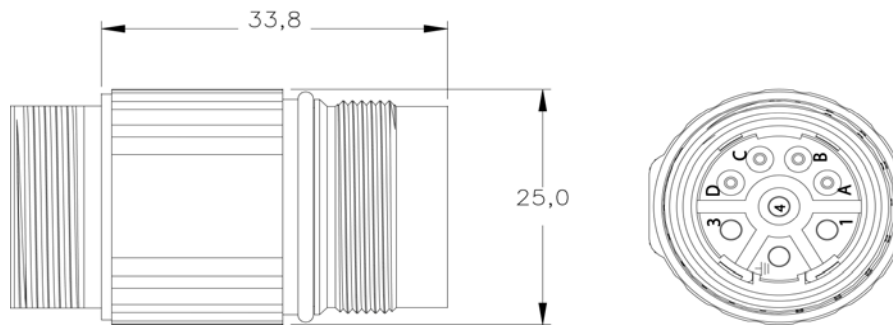

TECHNICAL DATA

TEMPERATURE RANGE:	-20C to +130C
PROTECTION:	IP 67 (Plugged Condition)
DEGREE OF PROTECTION:	3
OVER VOLTAGE CATEGORY:	III
HOUSING BODY:	ZINC DIE-CAST
COUPLING NUT:	BRASS, NICKEL-PLATED
INSULATION INSERTS:	PA66 / PBT, UL 94 / VO
CONTACTS:	BRASS, GOLD-PLATED
SEALS:	DUPONT VITON
MAX CURRENT:	MAX. 30A
CONTACT SIZE:	4 x 2.0mm / 4 x 1.0mm
MAXIMUM VOLTAGE:	630V AC/DC
CONTACT RESISTANCE:	<3
TEST VOLTAGE:	6000V
(BETWEEN CONTACTS)	
MAXIMUM MATING CYCLES:	>50