

**PLEASE CHECK WWW.MOLEX.COM FOR LATEST PART INFORMATION**

**Part Number:** [43045-2218](#)  
**Status:** **Active**  
**Overview:** Micro-Fit 3.0™ Connectors  
**Description:** Micro-Fit 3.0™ Header, Surface Mount, Dual Row, Vertical, with Solder Tab, 22 Circuits, Tin (Sn) Plating, Glow Wire Compatible

**Documents:**

<a href="#">3D Model</a>	<a href="#">Test Summary TS-43045-001 (PDF)</a>
<a href="#">Drawing (PDF)</a>	<a href="#">RoHS Certificate of Compliance (PDF)</a>
<a href="#">Product Specification PS-43045 (PDF)</a>	<a href="#">Product Literature (PDF)</a>

**Agency Certification**

CSA	LR19980
TUV	R72081037
UL	E29179

**General**

Product Family	PCB Headers
Series	<a href="#">43045</a>
Application	Power, Wire-to-Board
Comments	"High Temperature Square Pin Solder Type<P><P>This Molex product is manufactured from material that has the following ratings, tested by independent agencies:. a) A Glow Wire Ignition Temperature (GWIT) of at least 775 deg C per IEC 60695-2-13.. b) A Glow Wire Flammability Index (GWFI) above 850 deg C per IEC 60695-2-12.and hence complies with the requirements set out in the International Standard IEC 60335-1 5th edition - household and similar electrical appliances - safety, section 30 Resistance to heat and fire. <P><P> The customers using this product must determine its suitability for use in their particular application through testing or other acceptable means as described in end-product glow-wire flammability test standard IEC 60695-2-11 and any applicable product end-use standard(s). <P> If it is determined during the customer's evaluation of suitability, that higher performance is required, please contact Molex for possible product options."
Overview	<a href="#">Micro-Fit 3.0™ Connectors</a>
Product Literature Order No	987650-5984
Product Name	Micro-Fit 3.0™
UPC	800754376235

**Physical**

Breakaway	No
Circuits (Loaded)	22
Circuits (maximum)	22
Color - Resin	Black
Durability (mating cycles max)	30
Flammability	94V-0
Glow-Wire Compliant	Yes
Mated Height	17.27mm
Material - Metal	Brass
Material - Plating Mating	Tin
Material - Plating Termination	Tin

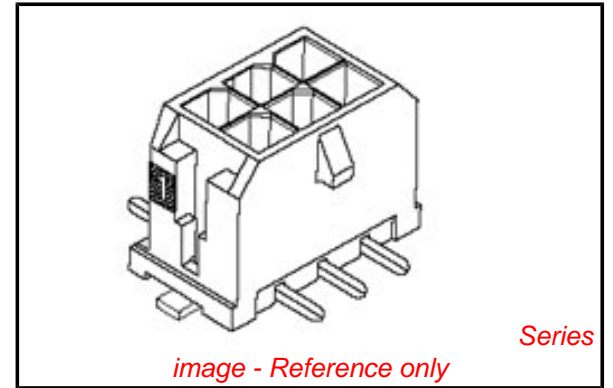

**EU RoHS**

**ELV and RoHS Compliant**

**REACH SVHC**

Not Reviewed

**Low-Halogen Status**

**Low-Halogen**

**China RoHS**



**Need more information on product environmental compliance?**

Email [productcompliance@molex.com](mailto:productcompliance@molex.com)  
 For a multiple part number RoHS Certificate of Compliance, [click here](#)

Please visit the [Contact Us](#) section for any non-product compliance questions.

**Search Parts in this Series**

[43045Series](#)

**Mates With**

[43025 Micro-Fit 3.0™ Receptacle Housing](#)

Material - Resin	High Temperature Thermoplastic
Net Weight	3.173/g
Number of Rows	2
Orientation	Vertical
PCB Locator	Yes
PCB Retention	Yes
PCB Thickness - Recommended	1.60mm
Packaging Type	Embossed Tape on Reel
Pitch - Mating Interface	3.00mm
Plating min - Mating	0.254µm
Polarized to PCB	Yes
Shrouded	Fully
Stackable	No
Surface Mount Compatible (SMC)	N/A
Temperature Range - Operating	-40°C to +105°C
Termination Interface: Style	Surface Mount

### **Electrical**

Current - Maximum per Contact	5A
Voltage - Maximum	600V

### **Solder Process Data**

Duration at Max. Process Temperature (seconds)	30
Lead-free Process Capability	Reflow Capable (SMT only)
Max. Cycles at Max. Process Temperature	3
Process Temperature max. C	260

### **Material Info**

### **Reference - Drawing Numbers**

Product Specification	PS-43045, RPS-43045-003, RPS-43045-004
Sales Drawing	SD-43045-007
Test Summary	TS-43045-001

This document was generated on 01/20/2015

**PLEASE CHECK [WWW.MOLEX.COM](http://WWW.MOLEX.COM) FOR LATEST PART INFORMATION**