



# FDMC86265P

## P-Channel PowerTrench<sup>®</sup> MOSFET

-150 V, -1 A, 1.2 Ω

### Features

- Max  $r_{DS(on)} = 1.2 \Omega$  at  $V_{GS} = -10 V$ ,  $I_D = -1 A$
- Max  $r_{DS(on)} = 1.4 \Omega$  at  $V_{GS} = -6 V$ ,  $I_D = -0.9 A$
- Very low RDS-on mid voltage P-channel silicon technology optimised for low Qg
- This product is optimised for fast switching applications as well as load switch applications
- 100% UIL Tested
- RoHS Compliant

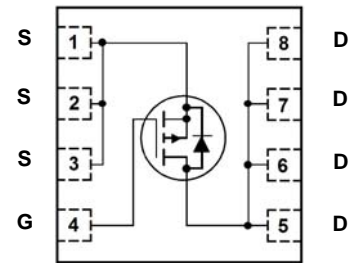
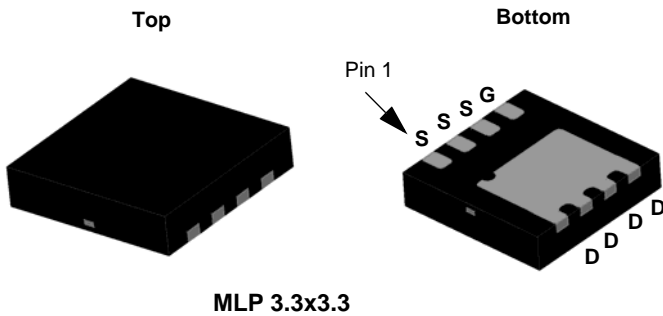


### General Description

This P-Channel MOSFET is produced using Fairchild Semiconductor's advanced PowerTrench<sup>®</sup> process that has been optimized for the on-state resistance and yet maintain superior switching performance.

### Applications

- Active Clamp Switch
- Load Switch



### MOSFET Maximum Ratings $T_A = 25^\circ C$ unless otherwise noted

Symbol	Parameter	Rated	Units
$V_{DS}$	Drain to Source Voltage	-150	V
$V_{GS}$	Gate to Source Voltage	$\pm 25$	V
$I_D$	Drain Current -Continuous	$T_C = 25^\circ C$	-1.8
	-Continuous	$T_A = 25^\circ C$ (Note 1a)	-1
	-Pulsed		-2
$E_{AS}$	Single Pulse Avalanche Energy	(Note 3)	6
$P_D$	Power Dissipation	$T_C = 25^\circ C$	16
	Power Dissipation	$T_A = 25^\circ C$ (Note 1a)	2.3
$T_J, T_{STG}$	Operating and Storage Junction Temperature Range	-55 to + 150	$^\circ C$

### Thermal Characteristics

$R_{\theta JC}$	Thermal Resistance, Junction to Case	7.5	$^\circ C/W$
$R_{\theta JA}$	Thermal Resistance, Junction to Ambient (Note 1a)	53	

### Package Marking and Ordering Information

Device Marking	Device	Package	Reel Size	Tape Width	Quantity
FDMC86265P	FDMC86265P	Power 33	13 "	12 mm	3000 units

## Electrical Characteristics $T_J = 25\text{ }^\circ\text{C}$ unless otherwise noted

Symbol	Parameter	Test Conditions	Min	Typ	Max	Units
--------	-----------	-----------------	-----	-----	-----	-------

### Off Characteristics

$BV_{DSS}$	Drain to Source Breakdown Voltage	$I_D = -250\text{ }\mu\text{A}$ , $V_{GS} = 0\text{ V}$	-150			V
$\frac{\Delta BV_{DSS}}{\Delta T_J}$	Breakdown Voltage Temperature Coefficient	$I_D = -250\text{ }\mu\text{A}$ , referenced to $25\text{ }^\circ\text{C}$		-125		mV/°C
$I_{DSS}$	Zero Gate Voltage Drain Current	$V_{DS} = -120\text{ V}$ , $V_{GS} = 0\text{ V}$			-1	$\mu\text{A}$
$I_{GSS}$	Gate to Source Leakage Current	$V_{GS} = \pm 25\text{ V}$ , $V_{DS} = 0\text{ V}$			$\pm 100$	nA

### On Characteristics

$V_{GS(th)}$	Gate to Source Threshold Voltage	$V_{GS} = V_{DS}$ , $I_D = -250\text{ }\mu\text{A}$	-2	-3.2	-4	V
$\frac{\Delta V_{GS(th)}}{\Delta T_J}$	Gate to Source Threshold Voltage Temperature Coefficient	$I_D = -250\text{ }\mu\text{A}$ , referenced to $25\text{ }^\circ\text{C}$		5		mV/°C
$r_{DS(on)}$	Static Drain to Source On Resistance	$V_{GS} = -10\text{ V}$ , $I_D = -1\text{ A}$		0.86	1.2	$\Omega$
		$V_{GS} = -6\text{ V}$ , $I_D = -0.9\text{ A}$		0.95	1.4	
		$V_{GS} = -10\text{ V}$ , $I_D = -1\text{ A}$ , $T_J = 125\text{ }^\circ\text{C}$		1.53	2.2	
$g_{FS}$	Forward Transconductance	$V_{DS} = -10\text{ V}$ , $I_D = -1\text{ A}$		1.9		S

### Dynamic Characteristics

$C_{iss}$	Input Capacitance	$V_{DS} = -75\text{ V}$ , $V_{GS} = 0\text{ V}$ , $f = 1\text{ MHz}$		158	210	pF
$C_{oss}$	Output Capacitance			16	25	pF
$C_{rss}$	Reverse Transfer Capacitance			0.7	5	pF
$R_g$	Gate Resistance		0.1	3	7.5	$\Omega$

### Switching Characteristics

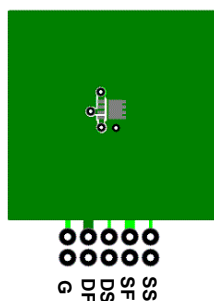
$t_{d(on)}$	Turn-On Delay Time	$V_{DD} = -75\text{ V}$ , $I_D = -1\text{ A}$ , $V_{GS} = -10\text{ V}$ , $R_{GEN} = 6\text{ }\Omega$		5.8	12	ns
$t_r$	Rise Time			2.2	10	ns
$t_{d(off)}$	Turn-Off Delay Time			8	16	ns
$t_f$	Fall Time			6.4	13	ns
$Q_{g(TOT)}$	Total Gate Charge		$V_{GS} = 0\text{ V to } -10\text{ V}$		2.8	4
$Q_{gs}$	Total Gate Charge	$V_{DD} = -75\text{ V}$ , $I_D = -1\text{ A}$		0.8		nC
$Q_{gd}$	Gate to Drain "Miller" Charge			0.7		nC

### Drain-Source Diode Characteristics

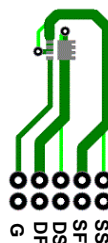
$V_{SD}$	Source to Drain Diode Forward Voltage	$V_{GS} = 0\text{ V}$ , $I_S = -1\text{ A}$ (Note 2)		-0.87	-1.3	V
$t_{rr}$	Reverse Recovery Time	$I_F = -1\text{ A}$ , $di/dt = 100\text{ A}/\mu\text{s}$		50	80	ns
$Q_{rr}$	Reverse Recovery Charge			78	124	nC

#### NOTES:

- $R_{\theta JA}$  is determined with the device mounted on a  $1\text{ in}^2$  pad 2 oz copper pad on a  $1.5 \times 1.5\text{ in.}$  board of FR-4 material.  $R_{\theta JC}$  is guaranteed by design while  $R_{\theta CA}$  is determined by the user's board design.



a)  $53\text{ }^\circ\text{C}/\text{W}$  when mounted on a  $1\text{ in}^2$  pad of 2 oz copper

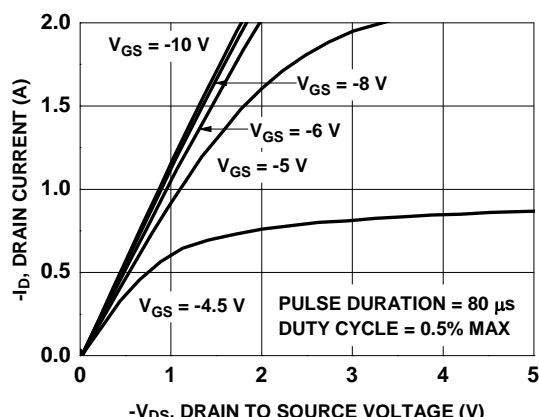


b)  $125\text{ }^\circ\text{C}/\text{W}$  when mounted on a minimum pad of 2 oz copper

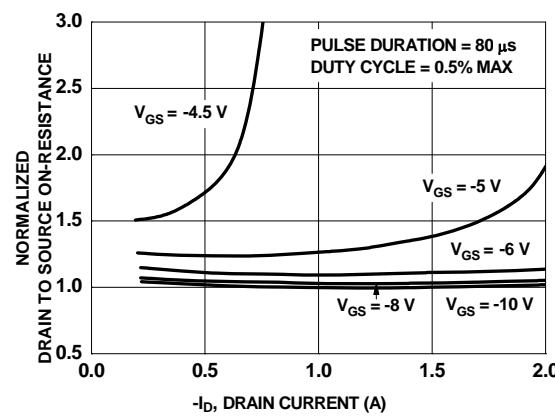
- Pulse Test: Pulse Width <  $300\text{ }\mu\text{s}$ , Duty cycle < 2.0%.

- Starting  $T_J = 25\text{ }^\circ\text{C}$ ; P-ch:  $L = 3\text{ mH}$ ,  $I_{AS} = -2\text{ A}$ ,  $V_{DD} = -150\text{ V}$ ,  $V_{GS} = -10\text{ V}$ . 100% test at  $L = 0.1\text{ mH}$ ,  $I_{AS} = -9\text{ A}$ .

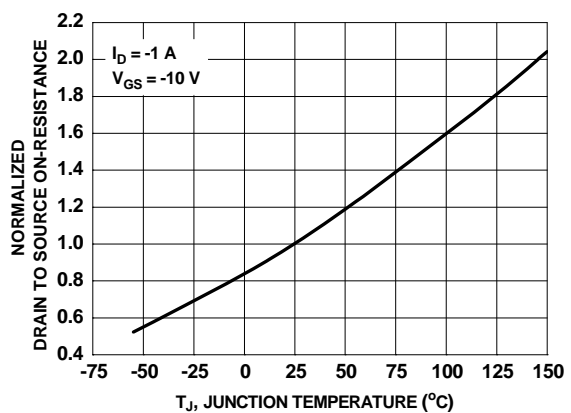
**Typical Characteristics**  $T_J = 25\text{ }^\circ\text{C}$  unless otherwise noted



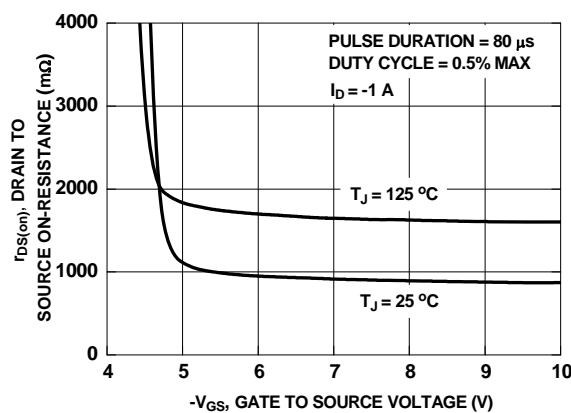
**Figure 1. On Region Characteristics**



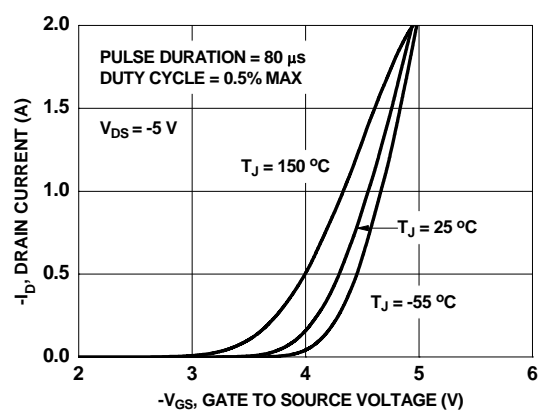
**Figure 2. Normalized On-Resistance vs Drain Current and Gate Voltage**



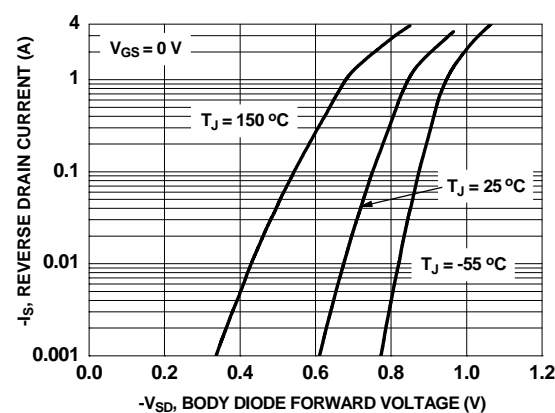
**Figure 3. Normalized On Resistance vs Junction Temperature**



**Figure 4. On-Resistance vs Gate to Source Voltage**

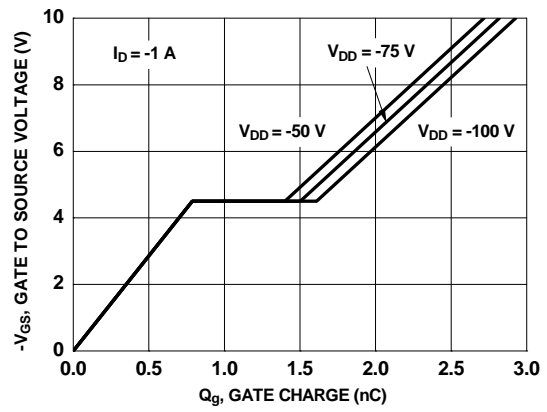


**Figure 5. Transfer Characteristics**

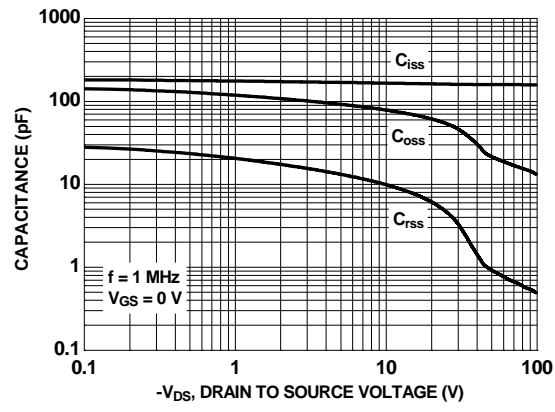


**Figure 6. Source to Drain Diode Forward Voltage vs Source Current**

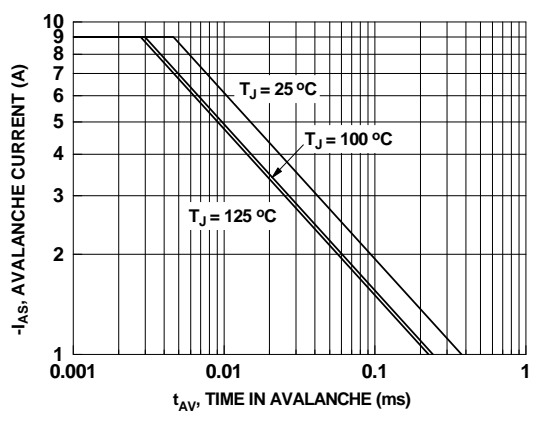
**Typical Characteristics**  $T_J = 25\text{ }^\circ\text{C}$  unless otherwise noted



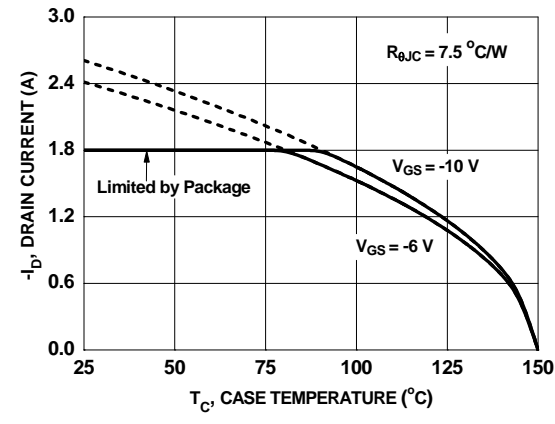
**Figure 7. Gate Charge Characteristics**



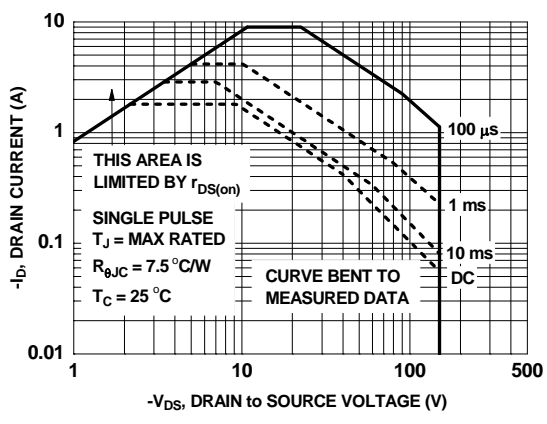
**Figure 8. Capacitance vs Drain to Source Voltage**



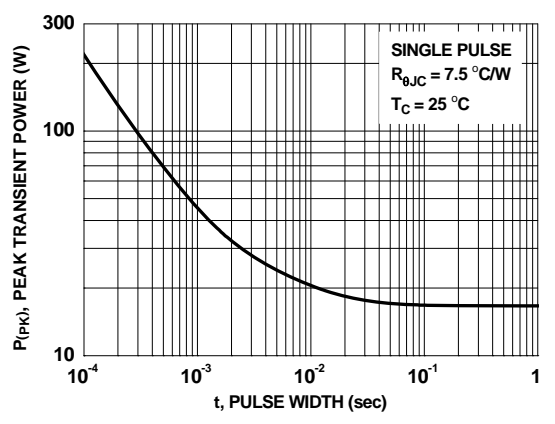
**Figure 9. Unclamped Inductive Switching Capability**



**Figure 10. Maximum Continuous Drain Current vs Case Temperature**

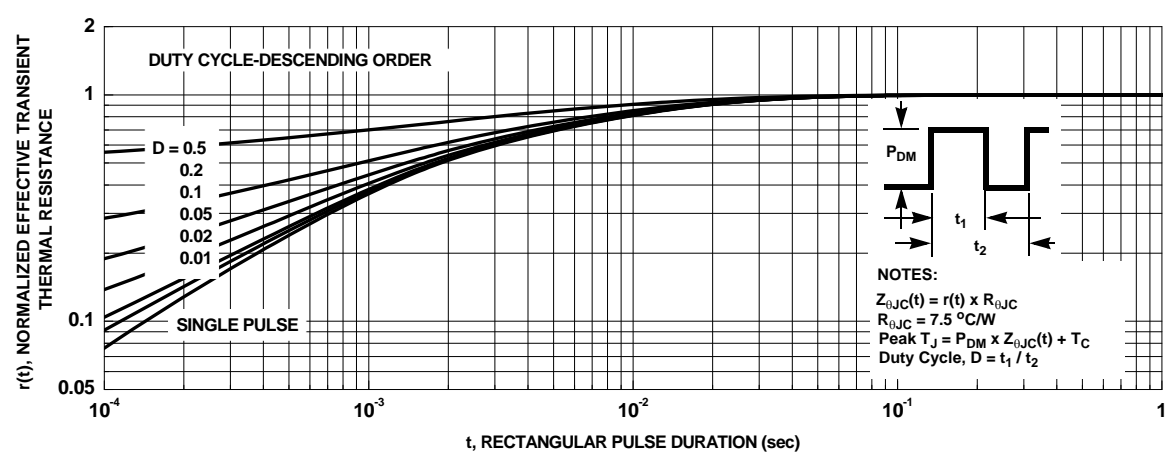


**Figure 11. Forward Bias Safe Operating Area**



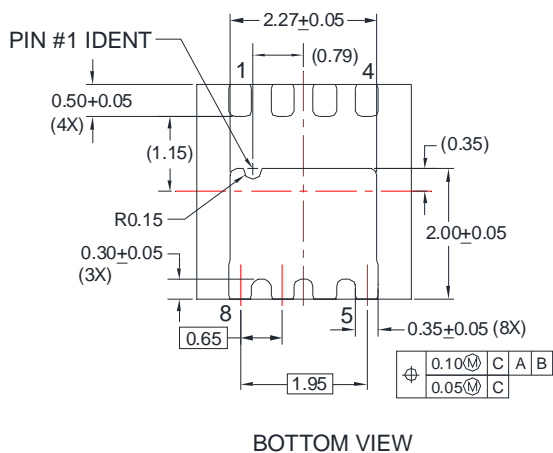
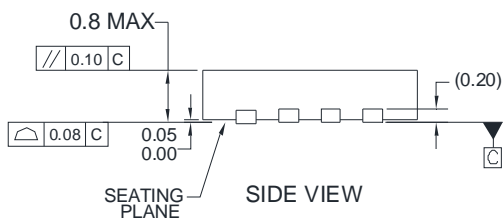
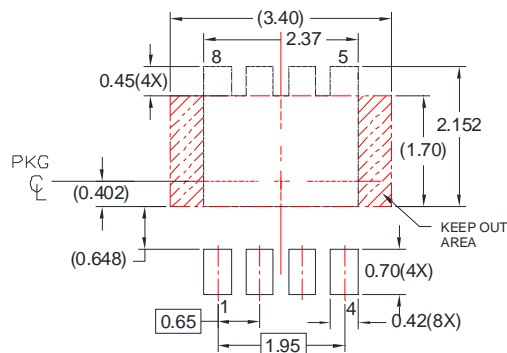
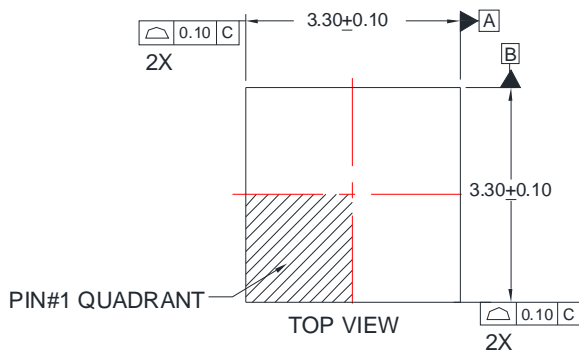
**Figure 12. Single Pulse Maximum Power Dissipation**

**Typical Characteristics**  $T_J = 25\text{ }^\circ\text{C}$  unless otherwise noted



**Figure 13. Junction-to-Case Transient Thermal Response Curve**

## Dimensional Outline and Pad Layout



### NOTES:

- A. DOES NOT CONFORM TO JEDEC REGISTRATION MO-229
- B. DIMENSIONS ARE IN MILLIMETERS.
- C. DIMENSIONS AND TOLERANCES PER ASME Y14.5M, 1994
- D. LAND PATTERN RECOMMENDATION IS BASED ON FSC DESIGN ONLY
- E. DRAWING FILE NAME : MKT-MLP08Srev2
- F. FAIRCHILD SEMICONDUCTOR


Package drawings are provided as a service to customers considering Fairchild components. Drawings may change in any manner without notice. Please note the revision and/or date on the drawing and contact a Fairchild Semiconductor representative to verify or obtain the most recent revision. Package specifications do not expand the terms of Fairchild's worldwide terms and conditions, specifically the warranty therein, which covers Fairchild products.

Always visit Fairchild Semiconductor's online packaging area for the most recent package drawings:  
[http://www.fairchildsemi.com/package/packageDetails.html?id=PN\\_MLDEU-C08](http://www.fairchildsemi.com/package/packageDetails.html?id=PN_MLDEU-C08)



**TRADEMARKS**

The following includes registered and unregistered trademarks and service marks, owned by Fairchild Semiconductor and/or its global subsidiaries, and is not intended to be an exhaustive list of all such trademarks.

- |   |   |                             |                  |
|---|---|-----------------------------|------------------|
| AccuPower™  | F-PFS™  | PowerTrench®                | SYSTEM GENERAL®  |
| AX-CAP®*  | FRFET®  | PowerXS™                    | TinyBoost®       |
| BitSiC™   | Global Power Resource™                          | Programmable Active Droop™  | TinyBuck®        |
| Build it Now™   | GreenBridge™                                    | QFET®                       | TinyCalc™        |
| CorePLUS™   | Green FPST™                                     | QS™                         | TinyLogic®       |
| CorePOWER™  | Green FPST™ e-Series™                           | Quiet Series™               | TINYOPTO™        |
| CROSSVOLT™  | Gmax™   | RapidConfigure™             | TinyPower™       |
| CTL™  | GTO™  | SignalWise™                 | TinyPWM™         |
| Current Transfer Logic™   | IntelliMAX™                                     | SmartMax™                   | TinyWire™        |
| DEUXPEED®   | ISOPLANAR™                                      | SMART START™                | TranSiC™         |
| Dual Cool™  | Marking Small Speakers Sound Louder and Better™ | Solutions for Your Success™ | TriFault Detect™ |
| EcoSPARK®   | MegaBuck™                                       | SPM®                        | TRUECURRENT®*    |
| EfficientMax™   | MICROCOUPLER™                                   | STEALTH™                    | μSerDes™         |
| ESBC™   | MicroFET™                                       | SuperFET®                   | UHC®             |
|  | MicroPak™                                       | SuperSOT™-3                 | Ultra FRFET™     |
| Fairchild®  | MicroPak2™                                      | SuperSOT™-6                 | UniFET™          |
| Fairchild Semiconductor®  | MillerDrive™                                    | SuperSOT™-8                 | VCX™             |
| FACT Quiet Series™  | MotionMax™                                      | SupreMOS®                   | VisualMax™       |
| FACT®   | mWSaver®  | SyncFET™                    | VoltagePlus™     |
| FAST®   | OptoHiT™  | Sync-Lock™                  | XS™              |
| FastvCore™  | OPTOLOGIC®                                      |                             | 仙童™              |
| FETBench™   |   |                             |                  |
| FPS™  |   |                             |                  |

\*Trademarks of System General Corporation, used under license by Fairchild Semiconductor.

**DISCLAIMER**

FAIRCHILD SEMICONDUCTOR RESERVES THE RIGHT TO MAKE CHANGES WITHOUT FURTHER NOTICE TO ANY PRODUCTS HEREIN TO IMPROVE RELIABILITY, FUNCTION, OR DESIGN. FAIRCHILD DOES NOT ASSUME ANY LIABILITY ARISING OUT OF THE APPLICATION OR USE OF ANY PRODUCT OR CIRCUIT DESCRIBED HEREIN; NEITHER DOES IT CONVEY ANY LICENSE UNDER ITS PATENT RIGHTS, NOR THE RIGHTS OF OTHERS. THESE SPECIFICATIONS DO NOT EXPAND THE TERMS OF FAIRCHILD'S WORLDWIDE TERMS AND CONDITIONS, SPECIFICALLY THE WARRANTY THEREIN, WHICH COVERS THESE PRODUCTS.

**LIFE SUPPORT POLICY**

FAIRCHILD'S PRODUCTS ARE NOT AUTHORIZED FOR USE AS CRITICAL COMPONENTS IN LIFE SUPPORT DEVICES OR SYSTEMS WITHOUT THE EXPRESS WRITTEN APPROVAL OF FAIRCHILD SEMICONDUCTOR CORPORATION.

As used here in:

- Life support devices or systems are devices or systems which, (a) are intended for surgical implant into the body or (b) support or sustain life, and (c) whose failure to perform when properly used in accordance with instructions for use provided in the labeling, can be reasonably expected to result in a significant injury of the user.
- A critical component in any component of a life support, device, or system whose failure to perform can be reasonably expected to cause the failure of the life support device or system, or to affect its safety or effectiveness.

**ANTI-COUNTERFEITING POLICY**

Fairchild Semiconductor Corporation's Anti-Counterfeiting Policy. Fairchild's Anti-Counterfeiting Policy is also stated on our external website, www.Fairchildsemi.com, under Sales Support.

Counterfeiting of semiconductor parts is a growing problem in the industry. All manufactures of semiconductor products are experiencing counterfeiting of their parts. Customers who inadvertently purchase counterfeit parts experience many problems such as loss of brand reputation, substandard performance, failed application, and increased cost of production and manufacturing delays. Fairchild is taking strong measures to protect ourselves and our customers from the proliferation of counterfeit parts. Fairchild strongly encourages customers to purchase Fairchild parts either directly from Fairchild or from Authorized Fairchild Distributors who are listed by country on our web page cited above. Products customers buy either from Fairchild directly or from Authorized Fairchild Distributors are genuine parts, have full traceability, meet Fairchild's quality standards for handling and storage and provide access to Fairchild's full range of up-to-date technical and product information. Fairchild and our Authorized Distributors will stand behind all warranties and will appropriately address and warranty issues that may arise. Fairchild will not provide any warranty coverage or other assistance for parts bought from Unauthorized Sources. Fairchild is committed to combat this global problem and encourage our customers to do their part in stopping this practice by buying direct or from authorized distributors.

**PRODUCT STATUS DEFINITIONS**

**Definition of Terms**

Datasheet Identification	Product Status	Definition
Advance Information	Formative / In Design	Datasheet contains the design specifications for product development. Specifications may change in any manner without notice.
Preliminary	First Production	Datasheet contains preliminary data; supplementary data will be published at a later date. Fairchild Semiconductor reserves the right to make changes at any time without notice to improve design.
No Identification Needed	Full Production	Datasheet contains final specifications. Fairchild Semiconductor reserves the right to make changes at any time without notice to improve the design.
Obsolete	Not In Production	Datasheet contains specifications on a product that is discontinued by Fairchild Semiconductor. The datasheet is for reference information only.