

LR3 40-4/4

Line reactor

- 4 % Uk
- Power harmonic damping
- Increases the service life of consumers

Three-phase line and commutation reactor to IEC 61558-2-20, DIN EN 61558-2-20, VDE 0570 part 2-20, VDE 0532 (large reactors)

Attenuation of harmonics

Limitation of starting current

Increase of consumer lives

Bridging of main failures

Reduction of commutation effects

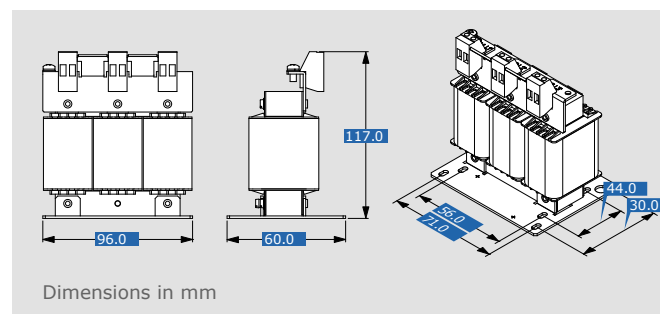



LR3 40-4/4

Line reactor



Input data

Rated voltage	3 x 400 V
Rated voltage (IEC)	3 x 690 V
Rated voltage (UL)	3 x 600 V
Rated voltage uk	3 x 400 V (50 Hz)
Rated frequency	50 - 60 Hz
Short circuit voltage	4 %
Voltage drop	9,2 V
Rated current	4.00 A

Standards and security

Protection index	IP 00
Safety class (prepared)	I
Cooling method	AN
Test voltage	4,0 kV
Class ISO (IEC)	B
Class ISO (UL)	class 130

General data

Inductivity	7.350 mH
Inductance deviation	±10%

Mechanical data

Type	open type
Fixing method	mounting brackets

BLOCK Transformatoren-Elektronik GmbH

Max-Planck-Straße 36-46

27283 Verden

Germany

Phone +49 4231 678-0

Fax +49 4231 678-177