

**FLUKE®**

# **725Ex**

Multifunction Process Calibrator

## Calibration Manual

## LIMITED WARRANTY AND LIMITATION OF LIABILITY

Each Fluke product is warranted to be free from defects in material and workmanship under normal use and service. The warranty period is one year and begins on the date of shipment. Parts, product repairs, and services are warranted for 90 days. This warranty extends only to the original buyer or end-user customer of a Fluke authorized reseller, and does not apply to fuses, disposable batteries, or to any product which, in Fluke's opinion, has been misused, altered, neglected, contaminated, or damaged by accident or abnormal conditions of operation or handling. Fluke warrants that software will operate substantially in accordance with its functional specifications for 90 days and that it has been properly recorded on non-defective media. Fluke does not warrant that software will be error free or operate without interruption.

Fluke authorized resellers shall extend this warranty on new and unused products to end-user customers only but have no authority to extend a greater or different warranty on behalf of Fluke. Warranty support is available only if product is purchased through a Fluke authorized sales outlet or Buyer has paid the applicable international price. Fluke reserves the right to invoice Buyer for importation costs of repair/replacement parts when product purchased in one country is submitted for repair in another country.

Fluke's warranty obligation is limited, at Fluke's option, to refund of the purchase price, free of charge repair, or replacement of a defective product which is returned to a Fluke authorized service center within the warranty period.

To obtain warranty service, contact your nearest Fluke authorized service center to obtain return authorization information, then send the product to that service center, with a description of the difficulty, postage and insurance prepaid (FOB Destination). Fluke assumes no risk for damage in transit. Following warranty repair, the product will be returned to Buyer, transportation prepaid (FOB Destination). If Fluke determines that failure was caused by neglect, misuse, contamination, alteration, accident, or abnormal condition of operation or handling, including overvoltage failures caused by use outside the product's specified rating, or normal wear and tear of mechanical components, Fluke will provide an estimate of repair costs and obtain authorization before commencing the work. Following repair, the product will be returned to the Buyer transportation prepaid and the Buyer will be billed for the repair and return transportation charges (FOB Shipping Point).

THIS WARRANTY IS BUYER'S SOLE AND EXCLUSIVE REMEDY AND IS IN LIEU OF ALL OTHER WARRANTIES, EXPRESS OR IMPLIED, INCLUDING BUT NOT LIMITED TO ANY IMPLIED WARRANTY OF MERCHANTABILITY OR FITNESS FOR A PARTICULAR PURPOSE. FLUKE SHALL NOT BE LIABLE FOR ANY SPECIAL, INDIRECT, INCIDENTAL, OR CONSEQUENTIAL DAMAGES OR LOSSES, INCLUDING LOSS OF DATA, ARISING FROM ANY CAUSE OR THEORY.

Since some countries or states do not allow limitation of the term of an implied warranty, or exclusion or limitation of incidental or consequential damages, the limitations and exclusions of this warranty may not apply to every buyer. If any provision of this Warranty is held invalid or unenforceable by a court or other decision-maker of competent jurisdiction, such holding will not affect the validity or enforceability of any other provision.

Fluke Corporation  
P.O. Box 9090  
Everett, WA 98206-9090  
U.S.A.

Fluke Europe B.V.  
P.O. Box 1186  
5602 BD Eindhoven  
The Netherlands

11/99

To register your product online, visit [register.fluke.com](http://register.fluke.com)

# Table of Contents

Title	Page
Introduction.....	1
Read First – Safety Information.....	2
Symbols .....	3
Ex-Hazardous Areas .....	4
Specifications.....	5
DC Voltage Measurement .....	5
DC Voltage Source.....	5
Millivolt Measurement and Source* .....	5
DC mA Measurement and Source .....	5
Ohms Measurement.....	6
Ohms Source .....	6
Frequency Measurement.....	6
Frequency Source .....	6
Temperature, Thermocouples .....	7
Loop Power Supply .....	7
Entity Parameters.....	7
RTD Excitation (simulation) .....	7
Temperature, RTD Ranges, and Accuracies.....	8
Pressure Measurement .....	8
General Specifications .....	8
Basic Maintenance .....	9
Cleaning the Calibrator.....	9
Approved Batteries.....	9
Replacing the Batteries .....	9
Required Equipment .....	11
Performance Tests.....	12
Preparing for the Performance Tests .....	12
Upper Display Voltage Measurement Tests.....	13
Lower Display mV Measurement Tests .....	14
Lower Display Voltage Measurement Tests.....	15
Upper Display mA Measurement Tests.....	16
Lower Display mA Measurement Tests .....	17
Lower Display Frequency Measurement Test.....	18
Lower Display Frequency Source Test .....	19
Lower Display 4-Wire Resistance Measurement Tests.....	20
Lower Display 4-Wire RTD Measurement .....	21
Lower Display 3-Wire RTD Measurement .....	22
Lower Display Thermocouple Measurement Tests.....	23
Lower Display Thermocouple Source Tests.....	24
Lower Display mA Source Tests.....	25

Lower Display mV Source Tests.....	26
Lower Display Voltage Source Tests .....	26
Lower Display Ohms Source Tests .....	27
Pressure Module Input.....	28
Calibration Adjustment Procedures .....	28
Setup .....	28
Initiating Communication.....	29
Cal Volts Input .....	30
Cal Volts Output.....	31
Cal mA Input .....	32
Cal mA Output .....	33
Cal mV Input .....	34
Cal mV Output .....	35
Cal Thermocouples.....	36
Cal Ohms Hi Source.....	37
Cal Ohms Low Source.....	38
Cal RTD Low Range .....	39
Cal RTD Hi Range .....	40
Cal ISO Volts .....	41
Cal ISO mA .....	42
Replaceable Parts .....	43

# List of Tables

Table	Title	Page
1.	Symbols.....	3
2.	Approved Batteries.....	9
3.	Required Equipment and Software .....	11
4.	Upper Display Voltage Readings.....	13
5.	Lower Display mV Readings.....	14
6.	Lower Display Voltage Readings .....	15
7.	Upper Display mA Readings.....	16
8.	Lower Display mA Readings.....	17
9.	Lower Display Frequency Source Readings .....	19
10.	Lower Display 4-Wire Resistance Readings.....	20
11.	Lower Display 4-Wire and 3-Wire RTD Temperature Readings .....	21
12.	Type J Thermocouple Readings.....	23
13.	Lower Display Thermocouple Source Readings.....	24
14.	Lower Display mA Source Readings.....	25
15.	Lower Display mV Source Readings.....	26
16.	Lower Display Voltage Source Readings .....	26
17.	Lower Display Ohms Source Readings.....	27
18.	User Replaceable Parts.....	43



# List of Figures

Figure	Title	Page
1.	Replacing the Batteries.....	10
2.	Upper Display Voltage Test Connections.....	13
3.	Lower Display mV and Voltage Test Connections.....	14
4.	Upper Display mA Test Connections.....	16
5.	Lower Display mA Test Connections.....	17
6.	Lower Display Frequency Test Connections.....	18
7.	Lower Display Frequency Source Test Connections.....	19
8.	Lower Display 4-Wire Resistance Test Connections.....	20
9.	Lower Display 3-Wire Resistance Test Connections.....	22
10.	Lower Display Thermocouple Test Connections.....	23
11.	Lower Display mA Source Test.....	25
12.	Lower Display Ohms Source Test Connections.....	27
13.	Volts Input Calibration Connections.....	30
14.	Volts Output Calibration Connections.....	31
15.	mA Input Calibration Connections.....	32
16.	mA Output Calibration Connections.....	33
17.	mV Input Calibration Connections.....	34
18.	mV Output Calibration Connections.....	35
19.	Thermocouples Calibration Connections.....	36
20.	Ohms Hi Source Calibration Connections.....	37
21.	RTD Low Range Calibration Connections.....	39
22.	ISO Volts Calibration Connections.....	41
23.	ISO mA Calibration Connections.....	42



## Introduction

### Warning

**The information provided in this manual is for the use of qualified personnel only. Do not perform the verification tests or calibration procedures described in this manual unless qualified to do so.**

This Calibration Manual provides the following information for the Fluke 725Ex Multifunction Process Calibrator (also referred to as "the Calibrator" and/or "the UUT"):

- Safety information
- Specifications
- Static awareness
- Basic maintenance (cleaning, batteries, and fuses)
- Equipment required for performance tests and calibration
- Performance test procedures
- Calibration procedures
- List of replaceable parts

For complete operating instructions, refer to the appropriate *Users Manual* (located on the CD-ROM shipped with the instrument).

### Caution

**The Calibrator contains parts that can be damaged by static discharge. No procedure in this document requires the case to be opened. If the case is opened, follow the standard practices for handling static sensitive devices.**

To order accessories, receive operating assistance, or get the location of the nearest Fluke distributor or Service Center, call:

USA: 1-888-44-FLUKE (1-888-443-5853)  
Canada: 1-800-36-FLUKE (1-800-363-5853)  
Europe: +31 402-675-200  
Japan: +81-3-3434-0181  
Singapore: +65-738-5655  
Anywhere in the world: +1-425-446-5500  
Service in USA: 1-888-99-FLUKE (1-888-993-5853)

Or, visit Fluke's Web site at [www.fluke.com](http://www.fluke.com).

To register this product, visit [register.fluke.com](http://register.fluke.com)

## Read First – Safety Information

In this calibration manual, a **Warning** identifies conditions and actions that pose hazard(s) to the user. A **Caution** identifies conditions and actions that may damage the Calibrator or the test instruments.

### Warning

To avoid electric shock, injury, damage to the Calibrator, or ignition of an explosive atmosphere, follow all equipment safety procedures.

- Use the Calibrator only as described in this manual, the *725Ex Users Manual*, and the Fluke 725Ex CCD (Concept Control Drawing), or the protection provided by the Calibrator may be impaired.
- Inspect the Calibrator before use. Do not use it if it appears damaged.
- Check the test leads for continuity, damaged insulation, or exposed metal. Replace damaged test leads.
- When using probes, keep fingers behind the finger guards on the probes.
- Never apply more than 30.0 V between the input terminals, or between any terminal and earth ground.
- Applying more than 30.0 V to the input terminals invalidates the Calibrator's Ex Approval and may result in permanent damage to the unit so it can no longer be used.
- Use the proper terminals, mode, and range for the measuring or sourcing application.
- To prevent damage to the unit under test, be sure the Calibrator is in the correct mode before connecting the test leads.
- When making connections, connect the COM test probe before the live test probe. When disconnecting, disconnect the live probe before the COM probe.
- Never open the Calibrator case. Opening the case invalidates the Calibrator's Ex Approval.
- Make sure the battery door is closed and latched before entering an Ex-hazardous area or using the Calibrator. See "Ex-Hazardous Areas".
- Replace the batteries as soon as the  (low battery) symbol appears to avoid false readings that can lead to electric shock. Remove the Calibrator from the Ex-hazardous area before opening the battery door. See "Ex-Hazardous Areas".
- Remove test leads from the Calibrator before opening the battery door.
- Measurement Category I (CAT I) is defined for measurements performed on circuits not directly connected to the mains.
- Turn off circuit power before connecting the Calibrator mA and COM terminals in the circuit. Place the Calibrator in series with the circuit.

- When servicing the Calibrator, use only specified replacement parts. Do not open the Calibrator case. Opening the case invalidates the Calibrator's Ex Approval.
- Do not allow water inside the case.
- Before each use, verify the Calibrator's operation by measuring a known voltage.
- Never touch the probe to a voltage source when the test leads are plugged into the current terminals.
- Do not operate the Calibrator around explosive dust.
- When using a pressure module, make sure the process pressure line is shut off and depressurized before connecting it or disconnecting it from the pressure module.
- Use four properly installed AA batteries to power the Calibrator.
- Use only the batteries listed in Table 2.
- Disconnect test leads from the circuit under test before changing to another measure or source function.
- Care must be taken to minimize the possibility of leakage when measuring the pressure of toxic or flammable gases. Confirm that all pressure connections are properly sealed.

**⚠ Caution**











To avoid possible damage to Calibrator or to equipment under test:

- Disconnect the power and discharge all high-voltage capacitors before testing resistance or continuity.
- Use the proper jacks, function, and range for the measurement or sourcing application.

## Symbols

Symbols used on the Calibrator and in this manual are explained in Table 1.

**Table 1. Symbols**

Symbol	Meaning
	DC - Direct Current
	Power ON/OFF
	Earth ground
	Conforms to ATEX requirements.
	Battery
	Risk of Danger. Important information. Refer to manual.
	Double insulated
	Conforms to relevant Canadian and US Standards.
	Conforms to relevant European Union directives.
	Pressure

## **Ex-Hazardous Areas**

An Ex-hazardous area as used in this manual refers to an area made hazardous by the potential presence of flammable or explosive vapors. These areas are also referred to as hazardous locations, see NFPA 70 Article 500 or CSA C22.1 Section 18.

The Model 725Ex Multifunction Calibrator has been designed for use in Ex-hazardous areas. These are areas where potentially flammable or explosive vapors may occur. These areas are referred to as hazardous (classified) locations in the United States, as Hazardous Locations in Canada, as Potentially Explosive Atmospheres in Europe and as Explosive Gas Atmospheres by most of the rest of the world. The Calibrator is designed as intrinsically safe. This means that connecting the Calibrator to equipment that is used within intrinsically safe circuits will not cause an ignition-capable arc as long as the entity parameters are suitably matched.

The Calibrator has two sets of parameters. The  $V_{max}$  and  $I_{max}$  parameters show the maximum voltage and maximum current that may be connected to the Calibrator terminals without compromising the intrinsic safety. The voltage and current will generally come from intrinsic safety barriers that provide power to the field equipment such as transmitters and positioners (I/P devices). These barriers are identified with a maximum open circuit voltage parameter ( $V_{oc}$ ) and a maximum short circuit current parameter ( $I_{sc}$ ). The matching criterion requires that  $V_{oc}$  of the barrier not exceed 30 V and  $I_{sc}$  not exceed 100 mA.

The Calibrator will itself be a source of voltage and current. Each set of terminals has a  $V_{oc}$  and an  $I_{sc}$  rating as shown on Fluke 725Ex CCD. When connecting terminals to other equipment, the  $V_{max}$  and  $I_{max}$  ratings on the other equipment must exceed the  $V_{oc}$  and  $I_{sc}$  ratings for the terminals connected to on the 725Ex Calibrator.

In addition to matching voltage and current entity parameters, it is also necessary to verify that capacitance and inductance has not been exceeded. Again, Fluke 725Ex CCD identifies the maximum capacitance ( $C_a$ ) and maximum inductance ( $L_a$ ) that is permitted based either on the intrinsic safety barrier ratings or on the Calibrator ratings for the specific terminals used. As an example, Fluke 725Ex CCD explains that the capacitance of each unit connected in the circuit ( $C_i$ ) plus the capacitance of the cable in the circuit must not exceed the maximum allowed capacitance ( $C_a$ ). Similarly for inductance in the intrinsically safe circuit.

When connecting the Calibrator into a powered circuit, i.e. when the circuit is powered by an intrinsic safety barrier, then the maximum circuit voltage used for the entity parameter evaluation will be the higher of either the Calibrator  $V_{oc}$  or of the barrier  $V_{oc}$ . The maximum current will be the sum of the Calibrator  $I_{sc}$  and the barrier  $I_{sc}$ . In this case, the maximum allowed inductance ( $L_a$ ) will be reduced. This value will have to be determined using the ignition curves found in standards such as CSA C22.2 No. 157 or UL 913.

For additional information about Ex-hazardous areas, refer to ANSI/ISA-12.01.01-1999 Definitions and Information Pertaining to Electrical Instruments in Hazardous (Classified) Locations and to ANSI/ISA-RP12.06.01-2003 Recommended Practice for Wiring Methods for Hazardous (Classified) Locations Instrumentation Part 1: Intrinsic Safety.

## Specifications

All specifications apply from +18 °C to +28 °C unless stated otherwise. All specifications assume a five-minute warmup period.

### DC Voltage Measurement

Range	Resolution	Accuracy, (% of Reading + Counts)
30 V (upper display)	0.001 V	0.02 % + 2
10 V (lower display)	0.001 V	0.02 % + 2
90 mV	0.01 mV	0.02 % + 2
Temperature coefficient -10 °C to 18 °C, +28 °C to 55 °C: ±0.005 % of range per °C		

### DC Voltage Source

Range	Resolution	Accuracy, (% of Reading + Counts)
100 mV	0.01 mV	0.02 % + 2
10 V	0.001 V	0.02 % + 2
Temperature coefficient -10 °C to 18 °C, +28 °C to 55 °C: ±0.005 % of range per °C		
Maximum load: 1 mA		

### Millivolt Measurement and Source\*

Range	Resolution	Accuracy
-10 mV to 75 mV	0.01 mV	±(0.025 % + 1 count)
Maximum input voltage: 30 V		
Temperature coefficient -10 °C to 18 °C, +28 °C to 55 °C: ±0.005 % of range per °C		
*Select this function by pressing <input type="checkbox"/> TC. The signal is available at the thermocouple miniplug connector.		

### DC mA Measurement and Source

Range	Resolution	Accuracy, (% of Reading + Counts)
24 mA	0.001 mA	0.02 % + 2
Temperature coefficient -10 °C to 18 °C, +28 °C to 55 °C: ±0.005 % of range per °C		
Drive capability: 250 Ω at 20 mA		

**Ohms Measurement**

Ohms Range	Accuracy $\pm \Omega^*$	
	4-Wire	2- and 3-Wire
0 to 400 $\Omega$	0.1	0.15
400 to 1.5 k $\Omega$	0.5	1.0
1.5 to 3.2 k $\Omega$	1	1.5

**Temperature coefficient -10 °C to 18 °C, +28 °C to 55 °C:**  $\pm 0.005$  % of range per °C  
**Excitation Current:** 0.2 mA  
**Maximum input voltage:** 30 V  
 \* 2-wire: Does not include lead resistance.  
 3-wire: Assumes matched leads with a total resistance not exceeding 100  $\Omega$ .

**Ohms Source**

Ohms Range	Excitation Current from Measurement Device	Accuracy $\pm \Omega$
15 to 400 $\Omega$	0.15 to 0.5 mA	0.15
15 to 400 $\Omega$	0.5 to 2 mA	0.1
400 to 1.5 k $\Omega$	0.05 to 0.8 mA	0.5
1.5 to 3.2 k $\Omega$	0.05 to 0.4 mA	1

**Temperature coefficient -10 °C to 18 °C, +28 °C to 55 °C:**  $\pm 0.005$  % of resistance range per °C

Resolution	
15 to 400 $\Omega$	0.1 $\Omega$
400 to 3.2 k $\Omega$	1 $\Omega$

**Frequency Measurement**

Range	Resolution	Accuracy
2.0 to 1000.0 CPM	0.1 CPM	$\pm (0.05 \% + 1 \text{ count})$
1 to 1000 Hz	1.0 Hz	$\pm (0.05 \% + 1 \text{ count})$
1.0 to 10.0 kHz	0.1 kHz	$\pm (0.05 \% + 1 \text{ count})$

**Sensitivity:** 1V peak-to-peak minimum  
**Waveform:** squarewave

**Frequency Source**

Range	Resolution	Accuracy (% of output frequency)
2.0 to 1000.0 CPM	0.1 CPM	$\pm 0.05 \%$
1 to 1000 Hz	1 Hz	$\pm 0.05 \%$
1.0 to 10.0 kHz	0.1 kHz	$\pm 0.25 \%$

**Waveform:** 5 V p-p squarewave, -0.1 V offset

**Temperature, Thermocouples**

Type	Range	Measure and Source Accuracies
J	-200 to 0 °C 0 to 1200 °C	1.0 °C 0.7 °C
K	-200 to 0 °C 0 to 1370 °C	1.2 °C 0.8 °C
T	-200 to 0 °C 0 to 400 °C	1.2 °C 0.8 °C
E	-200 to 0 °C 0 to 950 °C	0.9 °C 0.7 °C
R	-20 to 0 °C 0 to 500 °C 500 to 1750 °C	2.5 °C 1.8 °C 1.4 °C
S	-20 to 0 °C 0 to 500 °C 500 to 1750 °C	2.5 °C 1.8 °C 1.5 °C
B	600 to 800 °C 800 to 1000 °C 1000 to 1800 °C	2.2 °C 1.8 °C 1.4 °C
L	-200 to 0 °C 0 to 900 °C	0.85 °C 0.7 °C
U	-200 to 0 °C 0 to 400 °C	1.1 °C 0.75 °C
N	-200 to 0 °C 0 to 1300 °C	1.5 °C 0.9 °C
XK	-200 to 100 °C -100 to 800 °C	0.5 °C 0.6 °C
BP	0 to 800 °C 800 to 2500 °C	1.2 °C 2.5 °C
<b>Resolution:</b> 0.1 °C, 0.1 °F		

**Loop Power Supply**

- Voltage: 12 V
- Maximum current: 24 mA
- Short circuit protected

**Entity Parameters**

For Entity Parameters, Refer to Fluke 725Ex CCD for use in Ex-hazardous areas.

**RTD Excitation (simulation)**

Allowable Excitation by RTD type	
Ni 120	0.15 to 3.0 mA
Pt 100-385	0.15 to 3.0 mA
Pt 100-3926	0.15 to 3.0 mA
Pt 100-3916	0.15 to 3.0 mA
Pt 200-385	0.05 to 0.80 mA
Pt 500-385	0.05 to 0.80 mA
Pt 1000-385	0.05 to 0.40 mA

### Temperature, RTD Ranges, and Accuracies



Type	Range °C	Accuracy		
		Measure 4-Wire °C	Measure 2- and 3-Wire* °C	Source °C
Ni120	-80 to 260	0.2	0.3	0.2
Pt100-385	-200 to 800	0.33	0.5	0.33
Pt100-3926	-200 to 630	0.3	0.5	0.3
Pt100-3916	-200 to 630	0.3	0.5	0.3
Pt200-385	-200 to 250	0.2	0.3	0.2
	250 to 630	0.8	1.6	0.8
Pt500-385	-200 to 500	0.3	0.6	0.3
	500 to 630	0.4	0.9	0.4
Pt1000-385	-200 to 100	0.2	0.4	0.2
	100 to 630	0.2	0.5	0.2

**Resolution:** 0.1 °C, 0.1 °F  
**RTD Source:** Addresses pulsed transmitters and PLCs with pulses as short as 5 ms.  
\* 2-wire: Does not include lead resistance.  
3-wire: Assumes matched leads with a total resistance not exceeding 100 Ω.

### Pressure Measurement

Range	Resolution	Accuracy	Units
Determined by pressure module	5 digits	Determined by pressure module	psi, inH2O@4 °C, inH2O@20 °C, inH2O@60 °F, kPa, cmH2O@4 °C, cmH2O@20 °C, bar, mbar, kg/cm <sup>2</sup> , mmHg, inHg

### General Specifications

<b>Operating temperature</b>	-10 °C to 55 °C
<b>Storage temperature</b>	- 20 °C to 71 °C
<b>Operating altitude</b>	3000 meters above mean sea level
<b>Relative Humidity (% RH operating without condensation)</b>	90 % (10 to 30 °C) 75 % (30 to 40 °C) 45 % (40 to 50 °C) 35 % (50 to 55 °C) uncontrolled < 10 °C
<b>Vibration</b>	Random, 2 g, 5 to 500 Hz
<b>Product Compliance Markings</b>	 0344  II 1 G EEx ia [ia] IIB 171 °C KEMA 04ATEX1303X   Class I Div. 1 Groups B,C, and D LR110460 Class I Zone 0 Aex/Ex ia [ia] IIB 171 °C 2004.1573226 Ta = -10 °C... +55 °C Manufactured by Martel Electronics, Inc., 1F Commons Drive Londonderry, NH, USA
<b>EMC</b>	EN 61326-1: 1997 + A1; 1998 + A2:2000
<b>Power requirements</b>	4 AA alkaline batteries- See "Approved Batteries"
<b>Size</b>	96 x 200 x 47 mm. (3.75 x 7.9 x 1.86 in)
<b>Weight</b>	650 gm (1 lb, 7 oz)

## Basic Maintenance

### Cleaning the Calibrator

**⚠ Warning**

**To avoid personal injury or damage to the Calibrator, use only the specified replacement parts and do not allow water into the case.**

**⚠ Caution**

**To avoid damaging the plastic lens and case, do not use solvents or abrasive cleansers.**

Clean the Calibrator with a soft cloth dampened with water or water and mild soap.

Do not use aromatic hydrocarbons, chlorinated solvents, or methanol-based fluids when cleaning the Calibrator.

### Approved Batteries

**Table 2. Approved Batteries**

<b>Battery Manufacturer (All Batteries Alkaline- AA 1.5 V)</b>	<b>Type</b>
Duracell	MN1500
Eveready (Energizer)	E91
Panasonic Powerline	LR6A
Rayovac	815
Varta	4906
Ucar Gold	LR6

### Replacing the Batteries

**⚠ Warning**

- **To avoid false readings, which could lead to possible electric shock or personal injury, replace the batteries as soon as the battery indicator (🔋) appears.**
- **Remove the Calibrator from the Ex-hazardous area before opening the battery door. See “Ex-Hazardous Areas”.**
- **Use four properly installed AA batteries to power the Calibrator.**
- **Use only the batteries listed in Table 2.**

Four AA alkaline batteries are used to power the Calibrator. Use the following procedure to replace the batteries, see Figure 1 and Table 2:

1. Turn the Calibrator off, remove the test leads from the terminals, and hold the Calibrator face down.
2. Using a Hex Key, remove the battery door.
3. Remove the batteries, then install new batteries. Be sure to follow the polarity markings shown in the battery compartment.
4. Replace the battery door and secure it.

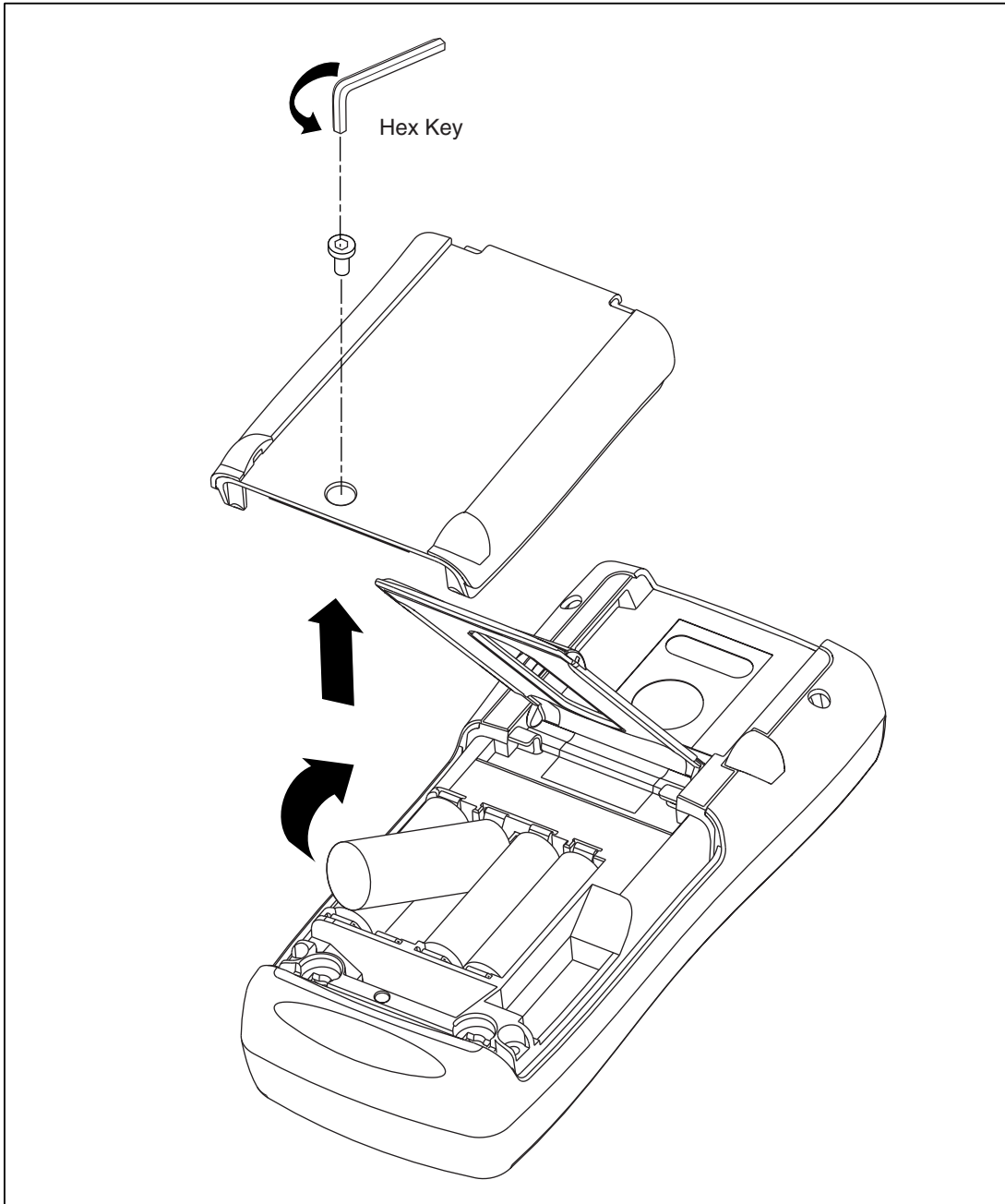

Figure 1. Replacing the Batteries

bah01f.eps

## Required Equipment

Equipment and software required to perform the procedures in this manual are identified in Table 3. If the recommended equipment model is not available, other equipment can be substituted if it meets the specifications indicated.

### ⚠ Warning

**To avoid safety hazards and equipment damage during the calibration procedures, use the specified calibration equipment listed in Table 3. Using unspecified equipment can give unreliable results and pose safety hazards.**

**Table 3. Required Equipment and Software**

Equipment	Minimum Specifications	Recommended Model
Multi-Product Calibrator	DC voltage: 0 V to 30 V Accuracy: $\pm 0.005\%$ DC current: 0 mA to 24 mA Accuracy: $\pm 0.005\%$ Temperature: Type J thermocouple 90 day accuracy: $\pm 0.2\text{ }^\circ\text{C}$ Resistance accuracy: $\pm 0.006\%$ Frequency accuracy: $\pm 0.01\%$	Fluke Model 5520A Multi-Product Calibrator only
MET/CAL <sup>®</sup> Metrology Software (see MET/CAL Installation and Upgrade Guide for minimum hardware requirements)	Version 6.0 or later	Contact Fluke for the latest version.
Digital Multimeter	DC voltage: 0 V to 24 V Accuracy: $\pm 0.0013\%$ DC voltage: 0 mA to 24 mA Accuracy: $\pm 0.005\%$	HP 3458A only— <i>no substitute</i>
Pressure Module	In working condition; for establishing communication only	Fluke 700PXX Series
Test Leads	Two sets of stackable banana test leads	2 red leads: Fluke PN 105809 2 black leads: Fluke PN 105806
Thermocouple test lead	2 type J male miniplugs with ~12" (30.5 cm) of 20-gauge type J thermocouple wire	Fluke Model 80CJ-M male miniplugs (package of two) 20-gauge type-J thermocouple wire is available through an electronic supply outlet
Personal computer	Windows <sup>®</sup> 3.1 or later with terminal communication software	486 (or later) IBM-compatible
PC interface cable	Fluke 700SC serial interface cable assembly (LEMO to DB-9 female)	Fluke PN 667425
Calibration cable	Fluke 724/725Ex Calibration Cable 700SC Serial Cable	Fluke PN 1556747 Fluke PN 667425

## Performance Tests

### Warning

**Some of the performance tests involve the use of high voltages and should be performed by qualified personnel only.**

**To avoid electric shock, always set the calibration source (5520A) to Standby (STBY) mode between tests and before handling the test connections or test cables.**

Performance tests confirm the complete operability of the Calibrator and check the accuracy of each function against the Calibrator's specifications.

#### *Note*

*If the Calibrator fails any performance test, it needs calibration adjustments. If the Calibrator continues to fail after calibration adjustments, send it to an authorized Fluke Service Center for repair.*

The Calibrator's performance and accuracy are specified for one year after calibration at operating temperatures of +18 °C to +28 °C (64 °F to 82 °F), in relative humidity to 90 %. The specifications assume the Calibrator has been warmed up for five minutes before use.

It is not necessary to open the case for the performance tests; no mechanical adjustments are necessary. Merely make the required connections, source the designated values, and determine if the reading on the Calibrator or the multimeter falls within the acceptable range indicated.

## Preparing for the Performance Tests

Performance tests for the Calibrator can be performed manually, or they can be computer-automated (using Fluke Metrology Software). The Metrology Software automates all of the performance-verification tasks, except for connection of the standards to the Calibrator. This document provides the procedures necessary for manual-performance tests. Contact Fluke for information on Metrology Software.

These performance tests assume that the person performing them knows how to use the Calibrator and the required equipment.

Do not attempt to perform these tests unless qualified to do so.

Throughout the performance tests, "UUT" (unit under test) refers to the Calibrator; the word "multimeter" is reserved for the digital multimeter identified in the required equipment listed in Table 3.

Unless otherwise indicated, all connection diagrams for the verification tests in this manual showing a calibrator or digital multimeter use a Fluke 5520A Calibrator or HP 3458A DMM. If using a different DMM, make the connections appropriate for that instrument.

To prepare the UUT for the performance tests, do the following:

1. Make sure that the required equipment is available, see Table 3.
2. Make sure the UUT has fresh batteries. See "Replacing the Batteries".
3. Warm up the Calibrator and multimeter as required by their specifications.
4. Remove all test leads from the front of the UUT.
5. Make sure that the UUT is in a stable ambient temperature between 18 °C and 28 °C (64.4 °F and 82.4 °F) and that it has been warmed up for five minutes.

**Upper Display Voltage Measurement Tests**

1. Press **RESET** on the 5520A.
2. Press  $\frac{V}{\text{mA}}$  on the UUT until **V** appears on the upper display.
3. Make the connections shown in Figure 2.
4. Set up the 5520A to output each of the voltages in Table 4 and verify that the UUT readings are within the limits shown.
5. Press **STBY** on the 5520A.

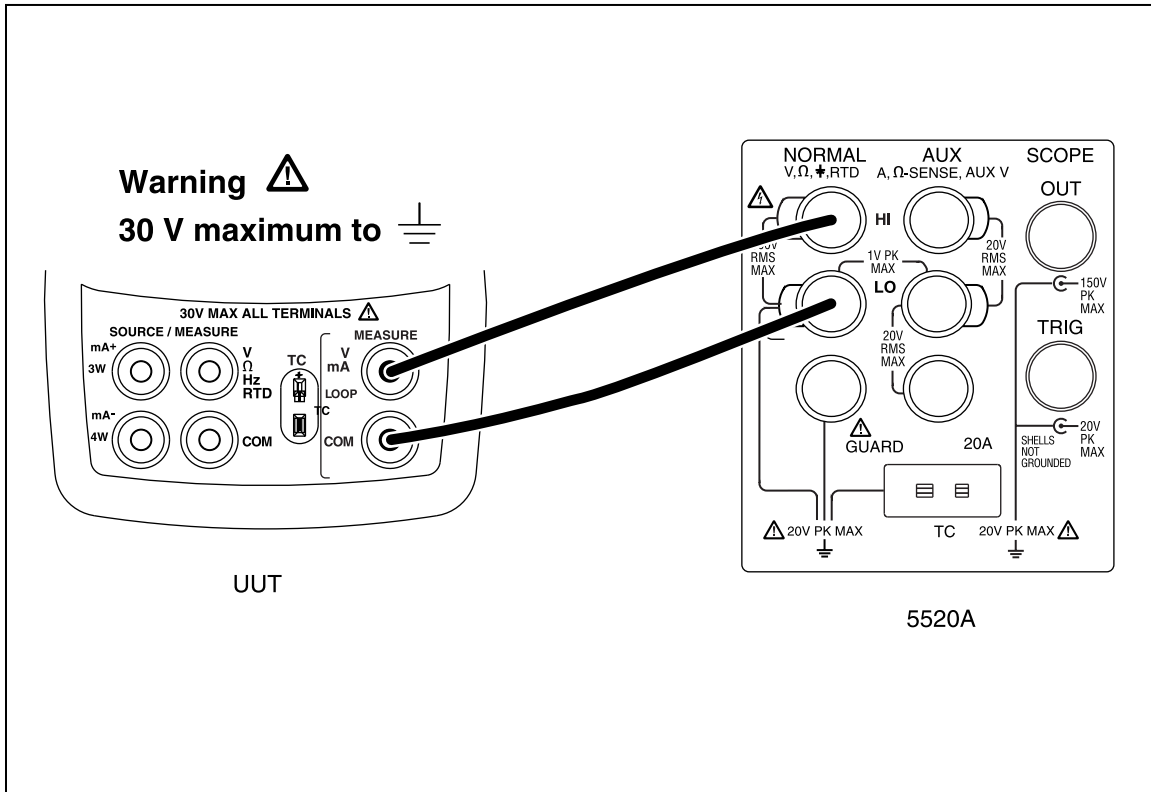

Figure 2. Upper Display Voltage Test Connections

aal03f.eps

Table 4. Upper Display Voltage Readings

5520A Outputs	UUT Readings
0.000 V	-0.002 V to +0.002 V
15.000 V	14.995 V to 15.005 V
30.000 V	29.992 V to 30.008 V

**Lower Display mV Measurement Tests**

1. Press **RESET** on the 5520A.
2. Press **[V mA]** on the UUT until **MEASURE** and **mV** appear on the lower display.
3. Make the connections shown in Figure 3.
4. Set up the 5520A to output each of the voltages in Table 5 and verify that the UUT readings are within the limits shown.
5. Press **STBY** on the 5520A.

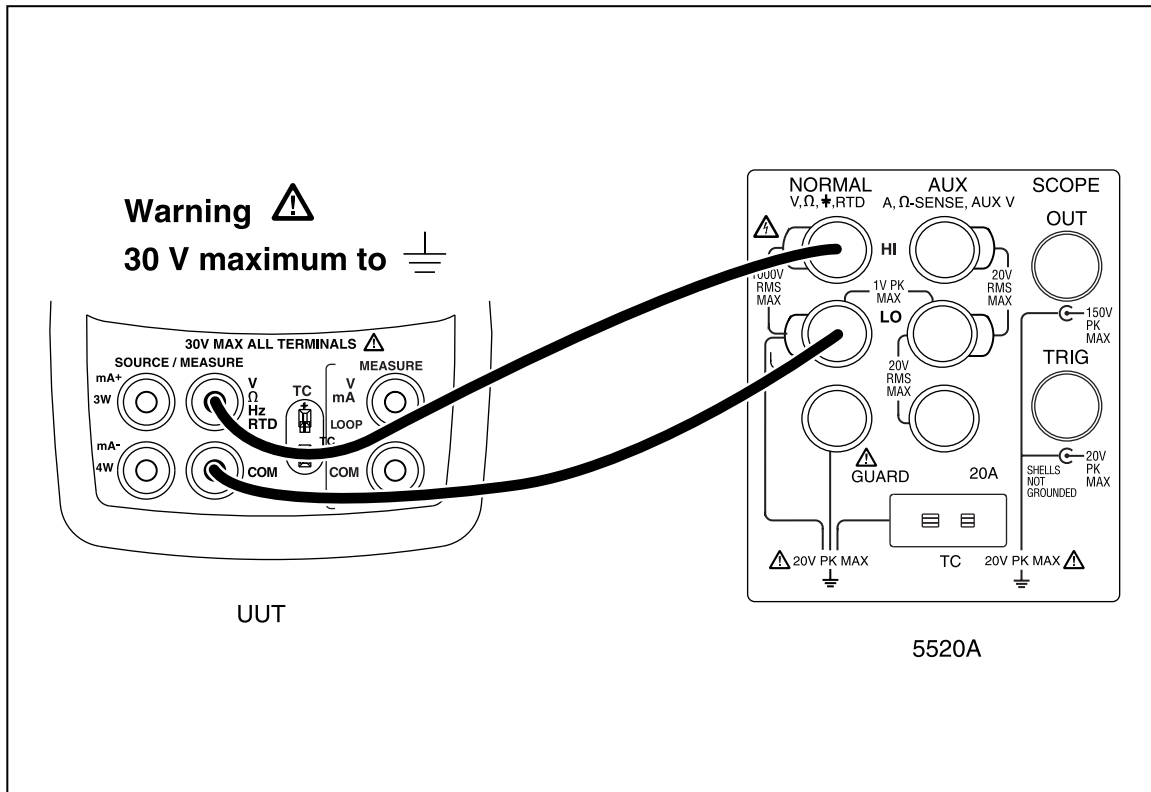

Figure 3. Lower Display mV and Voltage Test Connections

aal04f.eps

Table 5. Lower Display mV Readings

5520A Outputs	UUT Readings
0.00 mV	-0.02 mV to +0.02 mV
50.00 mV	49.97 mV to 50.03 mV
89.00 mV	88.96 mV to 89.04 mV

**Lower Display Voltage Measurement Tests**

1. Press **RESET** on the 5520A.
2. Press **V mA** on the UUT until **MEASURE** and **V** appear on the lower display.
3. Make the connections shown in Figure 3.
4. Set up the 5520A to output each of the voltages in Table 6 and verify that the UUT readings are within the limits shown.
5. Press **STBY** on the 5520A.

**Table 6. Lower Display Voltage Readings**

<b>5520A Outputs</b>	<b>UTT Readings</b>
0.000 V	-0.002 V to +0.002 V
10.000 V	9.996 V to 10.004 V
5.000 V	4.997 V to 5.003 V

### Upper Display mA Measurement Tests

1. Press **RESET** on the 5520A.
2. Press  $\text{V}_{\text{mA LOOP}}$  on the UUT until **MEASURE** and **mA** appear on the upper display.
3. Make the connections shown in Figure 4.
4. Set up the 5520A to output each of the voltages in Table 7 and verify that the UUT readings are within the limits shown.
5. Press **STBY** on the 5520A.

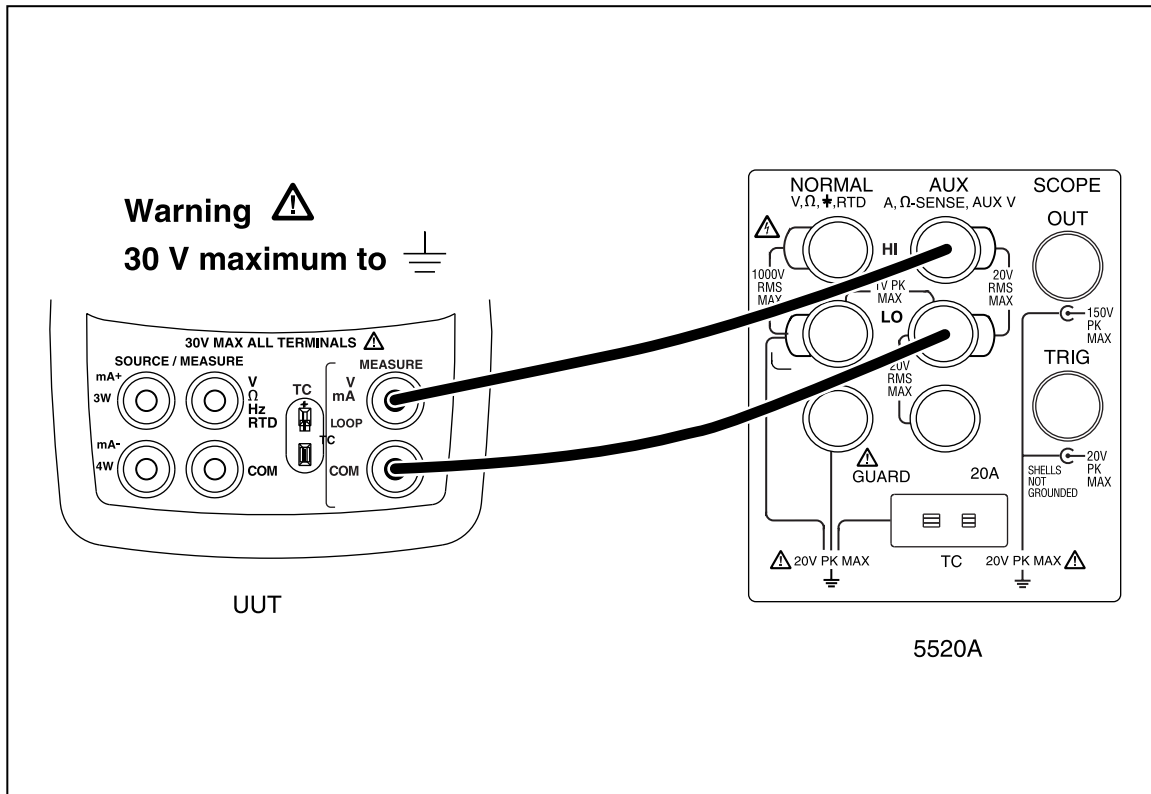

Figure 4. Upper Display mA Test Connections

aal05f.eps

Table 7. Upper Display mA Readings

5520A Settings	UUT Readings
0.000 mA	-0.002 mA to +0.002 mA
12.000 mA	11.995 mA to 12.005 mA
24.000 mA	23.993 mA to 24.007 mA

**Lower Display mA Measurement Tests**

1. Press **RESET** on the 5520A.
2. Press  $\frac{V}{mA}$   $\frac{mA}{LOOP}$  on the UUT until **MEASURE** and **mA** appear on the lower display.
3. Make the connections shown in Figure 5.
4. Set up the 5520A to output each of the voltages shown in Table 8 and verify that the UUT readings are within the limits shown.
5. Press **STBY** on the 5520A.

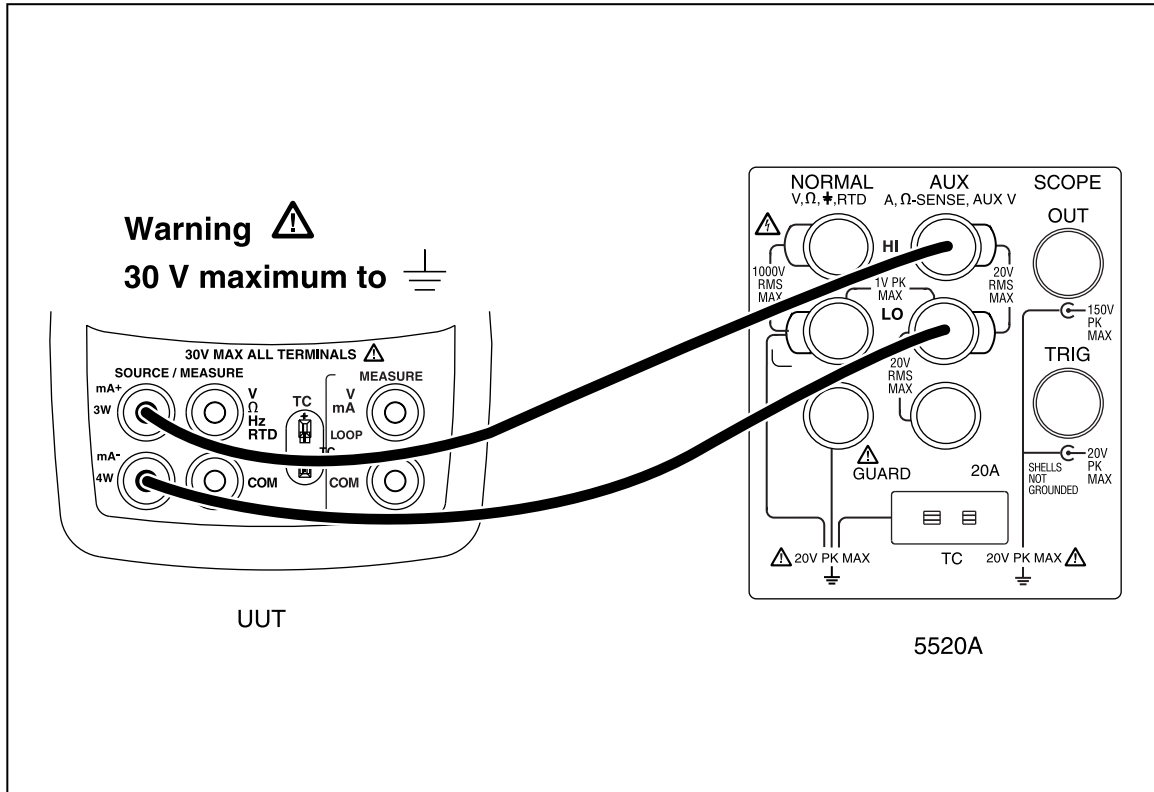

Figure 5. Lower Display mA Test Connections

aal06f.eps

Table 8. Lower Display mA Readings

5520A Outputs	UUT Readings
0.000 mA	-0.002 mA to +0.002 mA
12.000 mA	11.995 mA to 12.005 mA
24.000 mA	23.993 mA to 24.007 mA

### Lower Display Frequency Measurement Test

1. Set the 5520A to source a 40 Hz, 1 V peak-to-peak square wave (use the blue softkey under the wave type to change the wave shape).
2. Press **Hz Ω** on the UUT until **MEASURE** and **Hz** appear on the lower display.
3. Make the connections shown in Figure 6.
4. Verify that the UUT frequency reads between 39.8 Hz and 40.2 Hz.
5. Press **Hz Ω** on the UUT to change the lower display to **kHz**.
6. Set the 5520A to source a 10 kHz, 1 V peak-to-peak square wave.
7. Verify that the UUT frequency reads between 9.98 kHz and 10.02 kHz.
8. Press **STBY** on the 5520A.

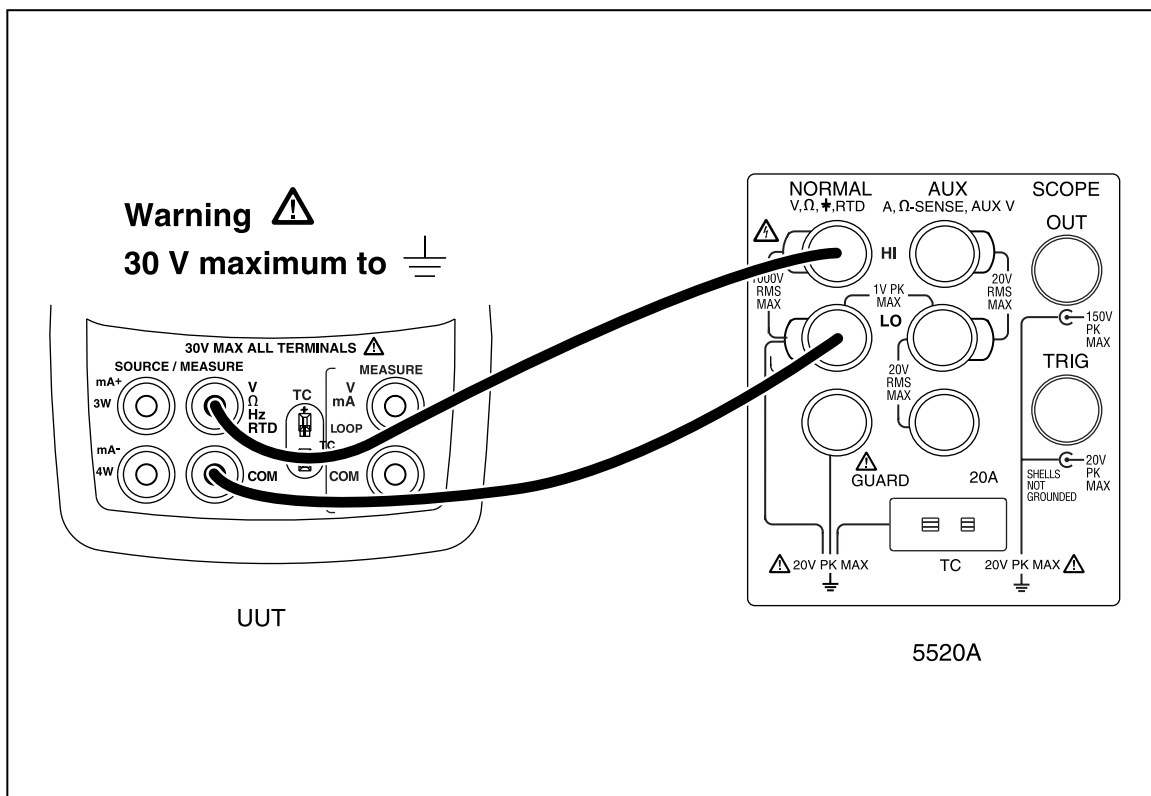





Figure 6. Lower Display Frequency Test Connections

aal04f.eps

### Lower Display Frequency Source Test

1. Press  on the UUT until **SOURCE** appears on the lower display.
2. Press  on the UUT until **Hz** appears on the lower display.
3. Configure the HP 3458A to measure frequency.
4. Make the connections shown in Figure 7.
5. Use the arrow keys on the UUT to set the UUT output to the frequencies in Table 9 and verify that the HP 3458A readings are within the limits shown. (Use  to change the UUT output to kilohertz when necessary.)
6. Press  on the UUT to disable the sourcing function.

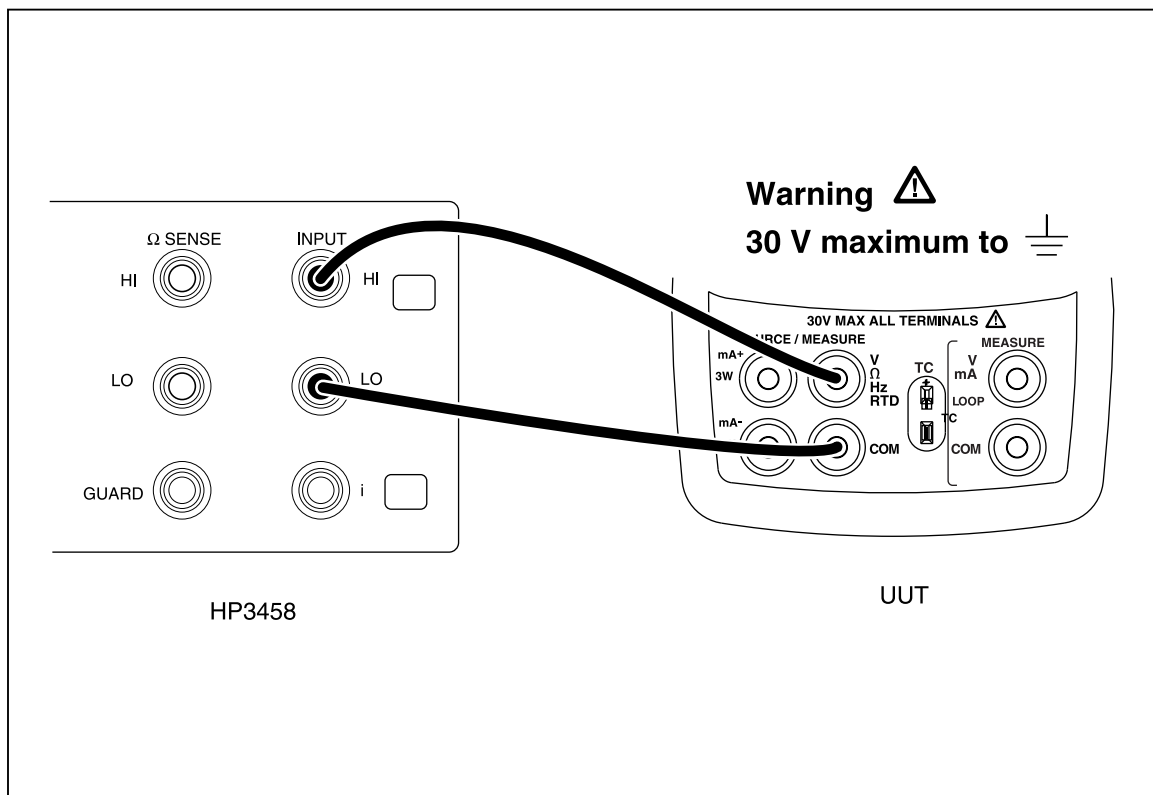

Figure 7. Lower Display Frequency Source Test Connections

aal08f.eps

Table 9. Lower Display Frequency Source Readings

UUT Outputs	HP 3458A Readings
40 Hz	39.98 Hz to 40.02 Hz
1000 Hz	999.5 Hz to 1000.5 Hz
1.0 kHz	997.5 Hz to 1002.5 Hz
4.0 kHz	3.990 Hz to 4.010 kHz
10.0 kHz	9.975 Hz to 10.025 kHz

### Lower Display 4-Wire Resistance Measurement Tests

1. Press  $\text{Hz } \Omega$  on the UUT until  $\Omega$  appears on the lower display. If necessary, use  $\text{MEAS}$  to get to the measure mode, and use  $\text{MODE}$  to get to the **4W** mode. (**MEASURE** should also appear on the lower display).
2. Set the 5520A to 2-wire output with 2-wire compensation off.
3. Make the connections shown in Figure 8.
4. Set the 5520A to source the resistance values in Table 10 and verify that the UUT resistance readings are within the limits shown.
5. Press **STBY** on the 5520A.

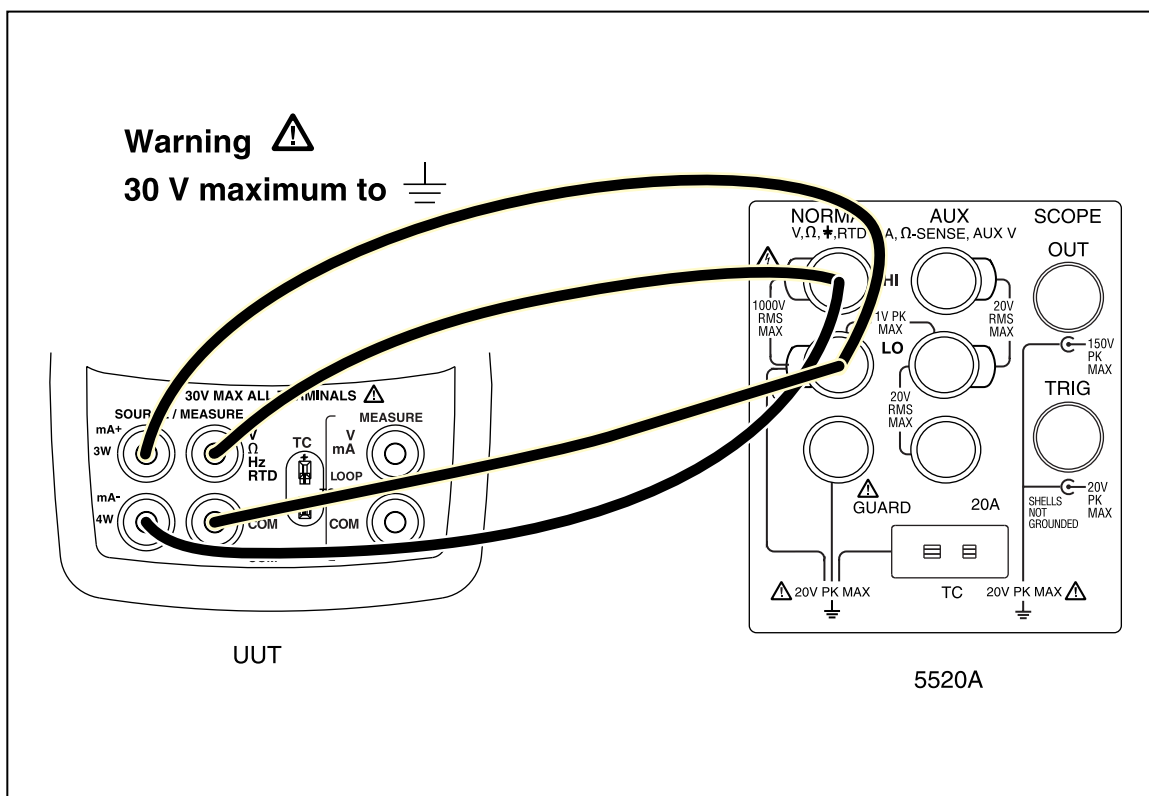

Figure 8. Lower Display 4-Wire Resistance Test Connections

aal09f.eps

Table 10. Lower Display 4-Wire Resistance Readings

5520A Outputs	UUT Readings
15.00 $\Omega$	14.90 $\Omega$ to 15.10 $\Omega$
300.00 $\Omega$	299.90 $\Omega$ to 300.10 $\Omega$
1500.0 $\Omega$	1499.5 $\Omega$ to 1500.5 $\Omega$
3000.0 $\Omega$	2999.0 $\Omega$ to 3001.0 $\Omega$

**Lower Display 4-Wire RTD Measurement**

1. Press **RTD** on the UUT until the lower display reads **PT3916**. If necessary, use **°C °F** to select °C units and **↺** to get to the **4W** mode. (**MEASURE** should also appear on the lower display.)
2. Set the 5520A to 2-wire output with 2-wire compensation off.
3. Make the connections shown in Figure 8.
4. Set the 5520A to source the resistance values in Table 11 and verify that the UUT temperature readings are within the limits shown for the 4-wire readings.

**Table 11. Lower Display 4-Wire and 3-Wire RTD Temperature Readings**

5520A Outputs (°C)	3-Wire UUT Readings (°C)	4-Wire UUT Readings (°C)
-180.0 (25.799 Ω)	-179.5 to -180.5	-179.7 to -180.3
100.0 (139.171 Ω)	99.5 to 100.5	99.7 to 100.3
550.0 (300.822 Ω)	549.5 to 550.5	549.7 to 550.3

### Lower Display 3-Wire RTD Measurement

1. Press **RTD** on the UUT until the lower display reads **PT3916**. If necessary, use **°C °F** to select °C units and the arrow keys to get to the **3W** mode. (**MEASURE** should also appear on the lower display.)
2. Set the 5520A to 2-wire output with 2-wire compensation off.
3. Make the connections shown in Figure 9.
4. Set the 5520A to source the resistance values in Table 11 and verify that the UUT temperature readings are within the limits shown for the 3-wire readings.
5. Press **STBY** on the 5520A.

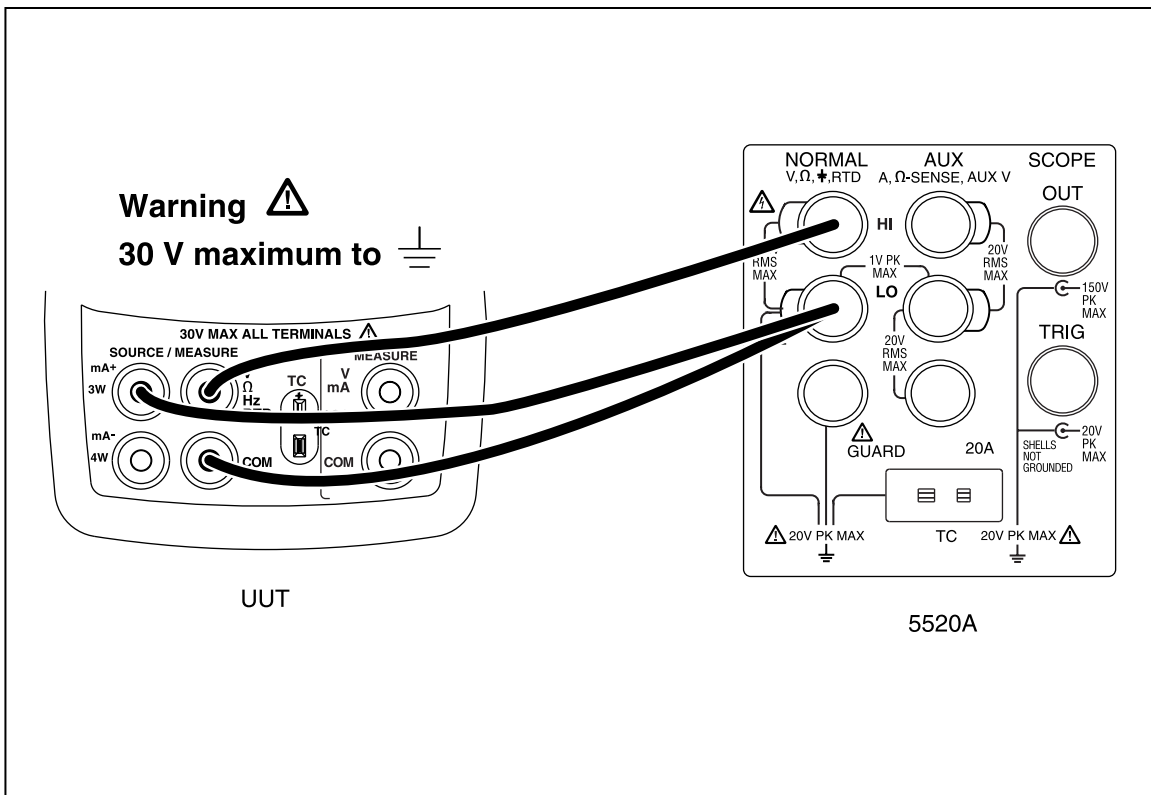

Figure 9. Lower Display 3-Wire Resistance Test Connections

aal10f.eps

**Lower Display Thermocouple Measurement Tests**

1. Remove the test leads from the UUT terminals; then connect a type J thermocouple lead between the TC jack on the UUT and the TC jack on the 5520A as shown in Figure 10.
2. Press **TC** on the UUT until **J** appears on the lower display. If necessary, press **°C °F** so the temperature is displayed in °C.
3. Set the 5520A to output the type J thermocouple voltages shown in Table 12 and verify the UUT temperature readings are within the limits shown (values use the ITS-90 curves).
4. Press **STBY** on the 5520A.

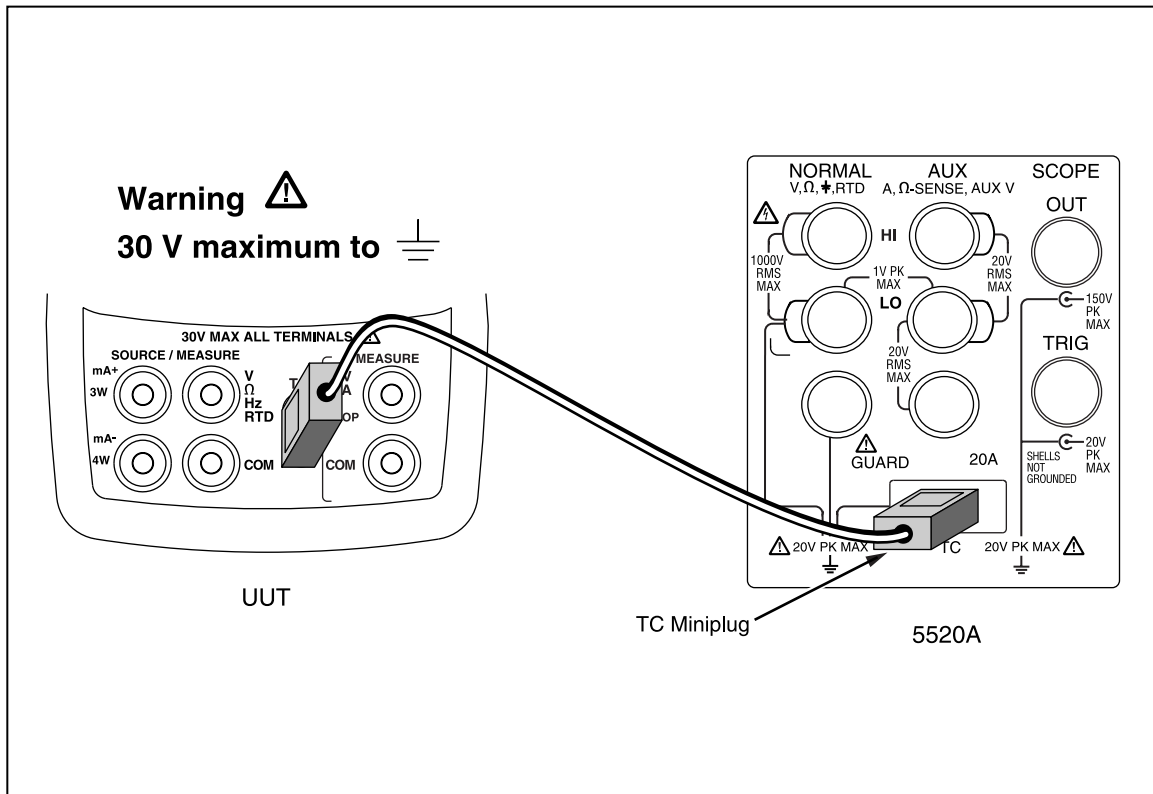





Figure 10. Lower Display Thermocouple Test Connections

aal11f.eps

Table 12. Type J Thermocouple Readings

5520A Settings (referenced to 0 °C)	UUT Readings
-180.0 °C (-7.403 mV)	-179.0 °C to -181.0 °C
0.0 °C (0.000 mV)	-0.7 °C to +0.7 °C
750.0 °C (42.281 mV)	749.3 °C to 750.7 °C



### Lower Display Thermocouple Source Tests

1. Set the 5520A to measure type J thermocouple voltages.
2. Press  on the UUT until **SOURCE** appears on the lower display. If necessary, press  on the UUT until **J** appears on the lower display and press  so the temperature is displayed in °C.
3. Use the arrow keys to set the UUT outputs to the temperatures in Table 13 and verify that the 5520A temperature readings are within the limits shown.
4. Press **STBY** on the 5520A. Remove the TC lead from the 5520A and the UUT.

**Table 13. Lower Display Thermocouple Source Readings**

UUT Settings	5520A Readings (referenced to 0 °C)
-180.0 °C	-179.0 °C to -181.0 °C
0.0 °C	-0.7 °C to +0.7 °C
750.0 °C	749.3 °C to 750.7 °C

### Lower Display mA Source Tests

1. Press  on the UUT until **SOURCE** appears on the lower display; then press  until **mA** appears on the lower display. If necessary, press  until **SOURCE** appears on the lower display.
2. Set the HP 3458A to measure dc current.
3. Connect the UUT and the HP 3458A as shown in Figure 11.
4. Use the arrow keys on the UUT to set the UUT to the currents in Table 14 and verify that the HP 3458A readings are within the limits shown.

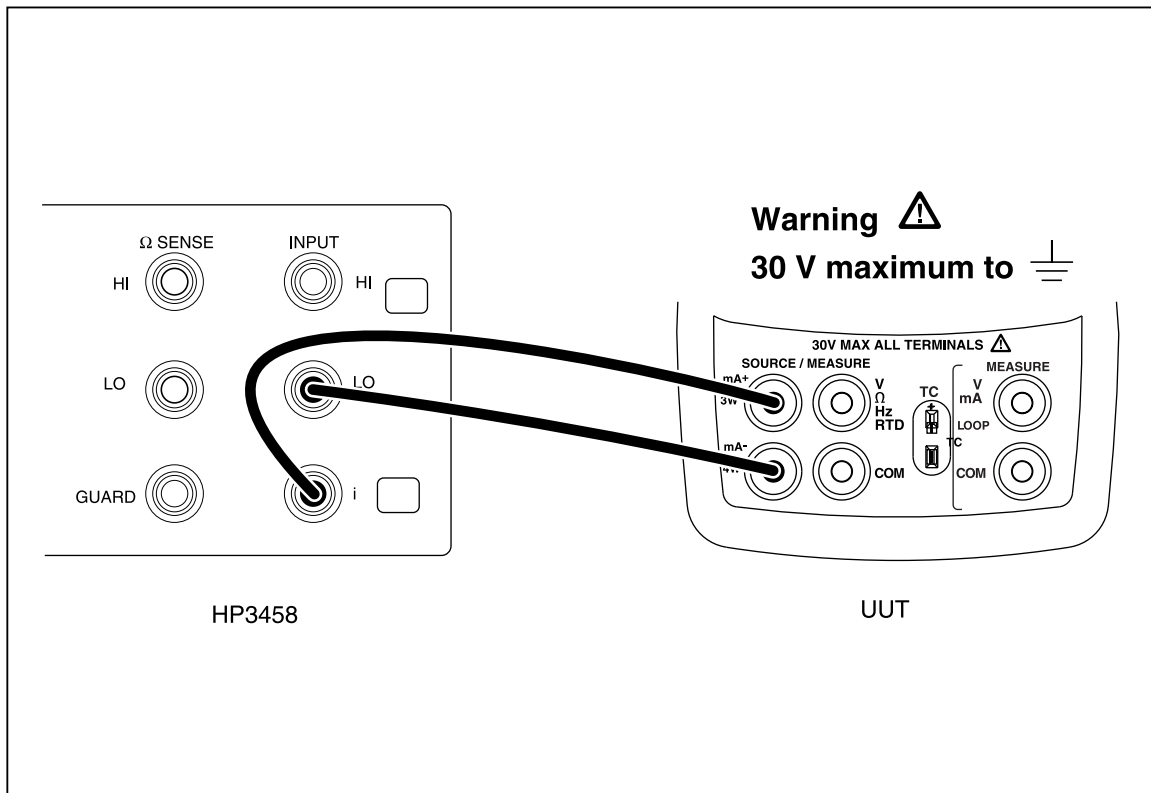





Figure 11. Lower Display mA Source Connections

aal12f.eps

Table 14. Lower Display mA Source Readings

UUT Outputs	HP 3458A Readings
4.000 mA	3.9972 mA to 4.0028 mA
12.000 mA	11.9956 mA to 12.0044 mA
20.000 mA	19.9940 mA to 20.0060 mA
24.000 mA	23.9932 mA to 24.0068 mA



### Lower Display mV Source Tests

1. Press  on the UUT until **SOURCE** appears on the lower display; then press  until **mV** appears on the lower display.
2. Set the HP 3458A to measure dc voltage in the 200 mV range.
3. Connect the UUT to the HP 3458A as shown in Figure 7.
4. Use the arrow keys on the UUT to set the UUT output to the current values in Table 15 and verify that the HP 3458A readings are within the limits shown.
5. Press  on the UUT to disable the sourcing function.

**Table 15. Lower Display mV Source Readings**

UUT Outputs	HP 3458A Readings
0.00 mV	-0.020 mV to +0.020 mV
50.00 mV	49.970 mV to 50.030 mV
100.00 mV	99.960 mV to 100.040 mV

### Lower Display Voltage Source Tests

1. Press  on the UUT until **SOURCE** appears on the lower display; then press  until **V** appears on the lower display.
2. Set the HP 3458A to measure dc voltage in the 20 V range.
3. Connect the UUT to the HP 3458A as shown in Figure 7.
4. Use the arrow keys on the UUT to set the UUT outputs to the currents in Table 16 and verify that the HP 3458A readings are within the limits shown. A lower voltage range on the HP 3458A may be used to verify the 0 V range.

**Table 16. Lower Display Voltage Source Readings**

UUT Outputs	HP 3458A Readings
0.000 V	-0.002 V to +0.002 V
5.000 V	4.9970 V to 5.0030 V
10.000 V	9.9960 V to 10.0040 V



### **Pressure Module Input**

1. Connect a Fluke 700 Series Pressure Module to the 5-pin LEMO connector at the top of the UUT; then press .
2. Verify that the display first shows -----**psi**, then changes to a pressure value.
3. Disconnect the pressure module from the UUT.

The performance tests are now complete. Disconnect and secure all test equipment.

### **Calibration Adjustment Procedures**

The 725Ex Calibrator has an electronic calibration. There are no mechanical adjustments and the calibration is done case closed. The calibration is done via a serial communications port, by sending and receiving commands and readings. For the serial port connection, the 700SC Serial Interface Cable (PN 667425) will be necessary. This permits communication through the pressure-port connection.

Throughout these procedures, the 725Ex is referred to as the UUT. Two methods of calibration are available for the UUT: using a serial-based program via a PC (see Table 3 for requirements), and using a Met/Cal calibration procedure. This manual only describes the serial-based PC program. The automated Met/Cal procedures are available from the Fluke Metrology Group. For more information on the automated Met/Cal procedures contact Fluke or visit the Fluke Web site at [www.fluke.com](http://www.fluke.com).

### **Setup**

Setup the PC and the UUT as follows:

1. Ensure that the terminal communications software is installed on the PC.
2. Connect the interface cable to the appropriate connector on the UUT.
3. Connect the 9-pin 'D' connector to the PC serial port. An adapter may be needed for PCs that use 25-pin 'D' serial connectors.
4. Verify the settings on the PC are as follows:
  - Bits per second: 9600
  - Data bits: 8
  - Parity: None
  - Stop bits: 1
  - Flow control: None
  - Local echo on

### **Initiating Communication**

Starting with the UUT off, push and hold **RECALL** while turning the UUT on. Continue to hold **RECALL** until "Cal mode" is displayed. The calibration menus, as seen on the PC screen, are as follows:

#### **725Ex Calibration Menu**

Calibrate Menu

- 1 - Cal Volts Input
- 2 - Cal Volts Output
- 3 - Cal mA Input
- 4 - Cal mA Output
- 5 - Cal mV Input
- 6 - Cal mV Output
- 7 - Cal Thermocouples
- 8 - Cal Ohms Hi Source
- 9 - Cal Ohms Low Source
- A - Cal RTD LOW Range
- B - Cal RTD HI Range
- C - Cal ISO Volts
- D - Cal ISO mA

Enter Selection :

To begin calibration, type the cal step (letter or number), then press Enter. It is not necessary to run all of the calibration steps when in the calibration mode.

When calibrating thermocouples, mV Input and mV Output must be calibrated first. At the end of each step on the calibration menu, the new calibration constants for that step are saved, but not actually used until power is recycled.

When calibrating a measurement function, an input signal must first be entered. When the signal is connected and stable, press the space bar to start the adjustment. Usually, the UUT will display a calibration constant, then prompt for a second input value. Apply the new input value, then press the space bar. After the adjustment is complete, press the space bar to return to the Calibration Menu.

When calibrating a source function, the value of a reading must be entered. Type in the numerical value of the calibration desired. This will put the UUT into the desired calibration mode. When entering the calibration data for any source mode calibration, be sure to enter the value in the units listed, but don't enter the units (mV, mA, etc.). After the adjustment is complete, press the space bar to return to Calibration Menu. The calibration values will vary slightly, unit to unit. The constants used in this procedure may not appear exactly the same as on your UUT, but they should be approximately the same.

### Cal Volts Input

Connect the UUT as shown in Figure 13.

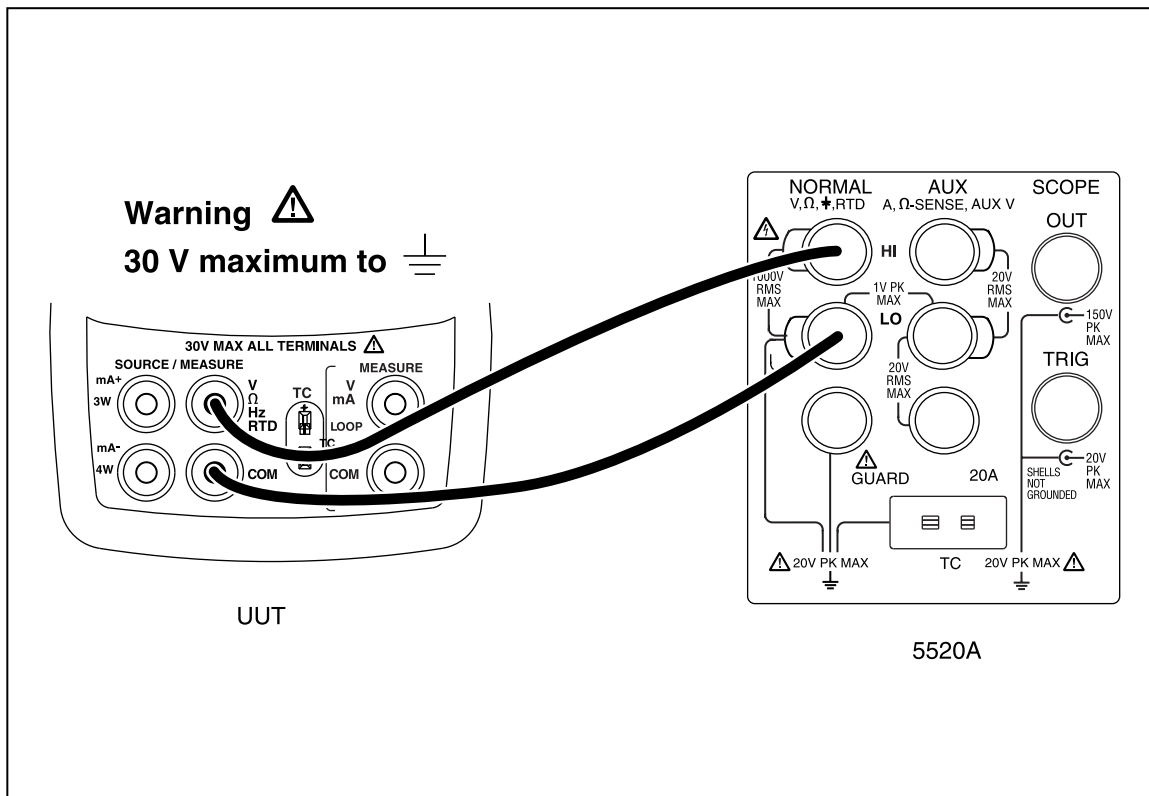

Figure 13. Volts Input Calibration Connections

aal04f.eps

From the Calibration Menu, type the cal step for Cal Volts Input. The PC displays:

```
Enter 0 Volts - press space bar to continue
```

Set the Fluke 5520A to output 0.0000 V, then press the space bar. After a short while, the following calibration constant and prompt are displayed on the PC:

```
Offset = -40
Enter 10.00 Volts - press space bar to continue
```

Set the Fluke 5520A to output 10.0000 V, and press the space bar. After a short while, the following calibration constants and prompt are displayed on the PC:

```
diff = (Counts - Offset)
3032676 = 3032636 - -40
Volts per count = 0.000003
- press space bar to continue
```

Press the space bar to return to the Calibration Menu.

### Cal Volts Output

Connect the UUT as shown in Figure 14.

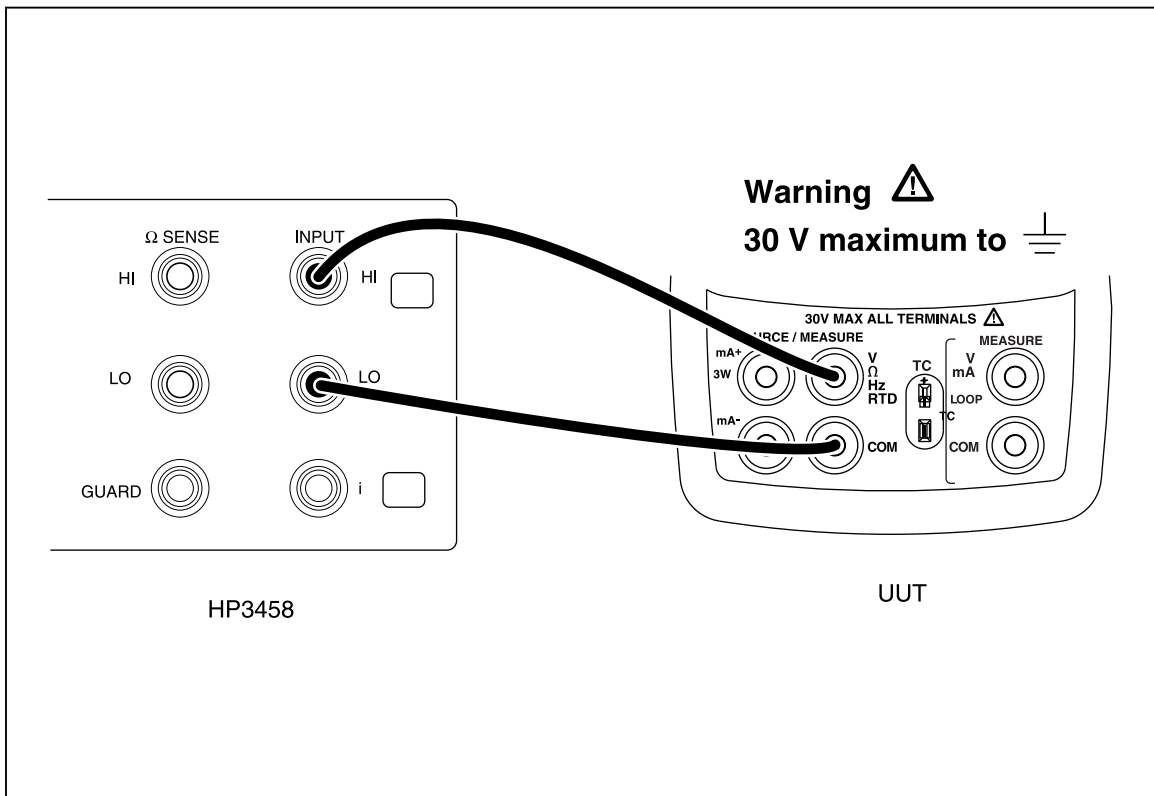

Figure 14. Volts Output Calibration Connections

aal08f.eps

From the Calibration Menu, type the number or letter for Cal Volts Output. The PC displays:

```
Zero into DAC. Enter the Volts displayed :
```

Set the HP 3458 to read V DC. Be sure the NPLC on the HP 3458 is slow enough to get stable readings to four decimal places. When the reading on the HP 3458 has stabilized, enter the value in volts on the PC, and press Enter. It is only necessary to enter four places past the decimal point. It is not necessary to enter the units (V). After a short while, the PC displays:

```
Max value into DAC. Enter the Volts displayed :
```

Enter the voltage reading (four places past the decimal) from the HP 3458 on the PC, then press Enter. After a short while the PC displays the following calibration constants and new prompt:

```
0.000170 = 11.071999 - 0.000000 )/ 65279.00
- press space bar to continue
```

Press the space bar to return to the Calibration Menu.

### Cal mA Input

Connect the UUT as shown in Figure 15.

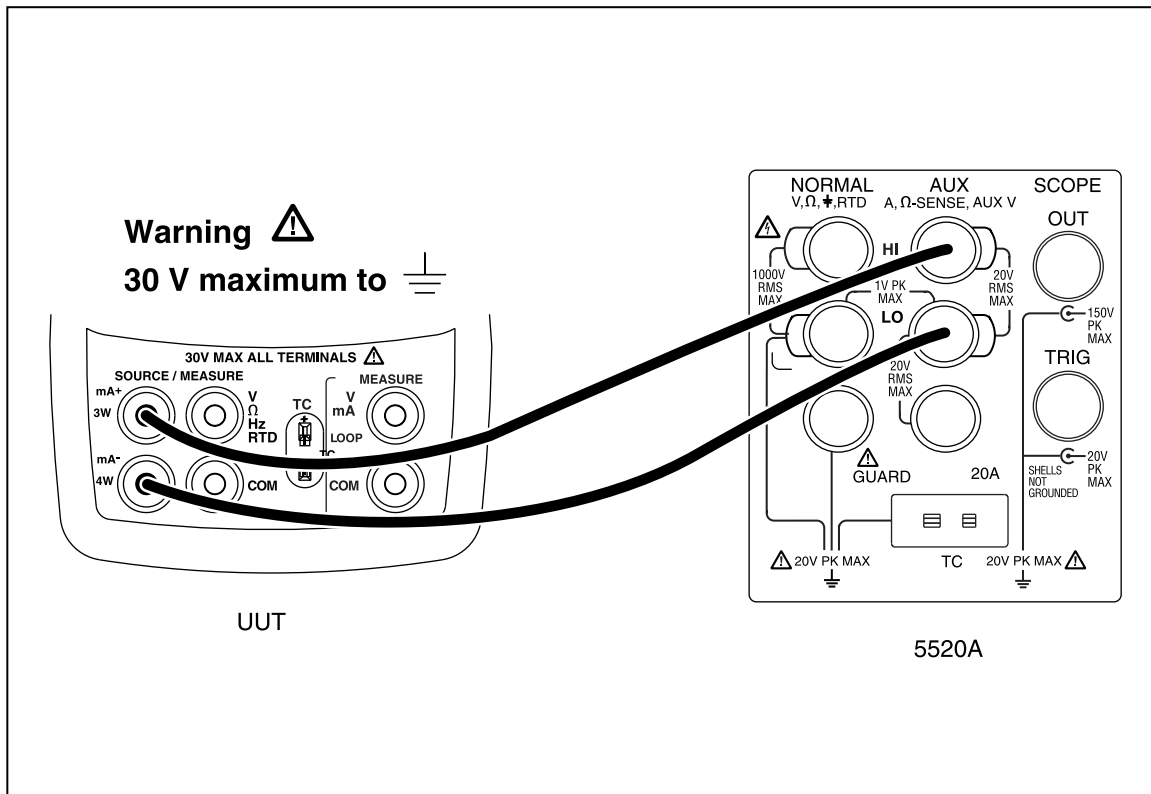

Figure 15. mA Input Calibration Connections

aal06f.eps

From the Calibration Menu, type the cal step for Cal mA Input. The PC displays:

```
Enter 0 ma - press space bar to continue
```

Set the Fluke 5520A to output 0.000 mA, let the reading settle a few seconds, then press the space bar on the PC. After a short while, the PC displays the following calibration constant and new prompt:

```
Offset = -337
Enter 24.00 ma - press space bar to continue
```

Set the Fluke 5520A to output 24.000 mA, let the reading settle a few seconds, then press the space bar on the PC. After a short while, the UUT displays the following calibration constants and new prompt:

```
diff = (Counts - Offset)
8106924 = 8106587 - -337
mA per count = 0.000003
press space bar to continue
```

Press the space bar to return to the Calibration Menu.

### Cal mA Output

Connect the UUT as shown in Figure 16.

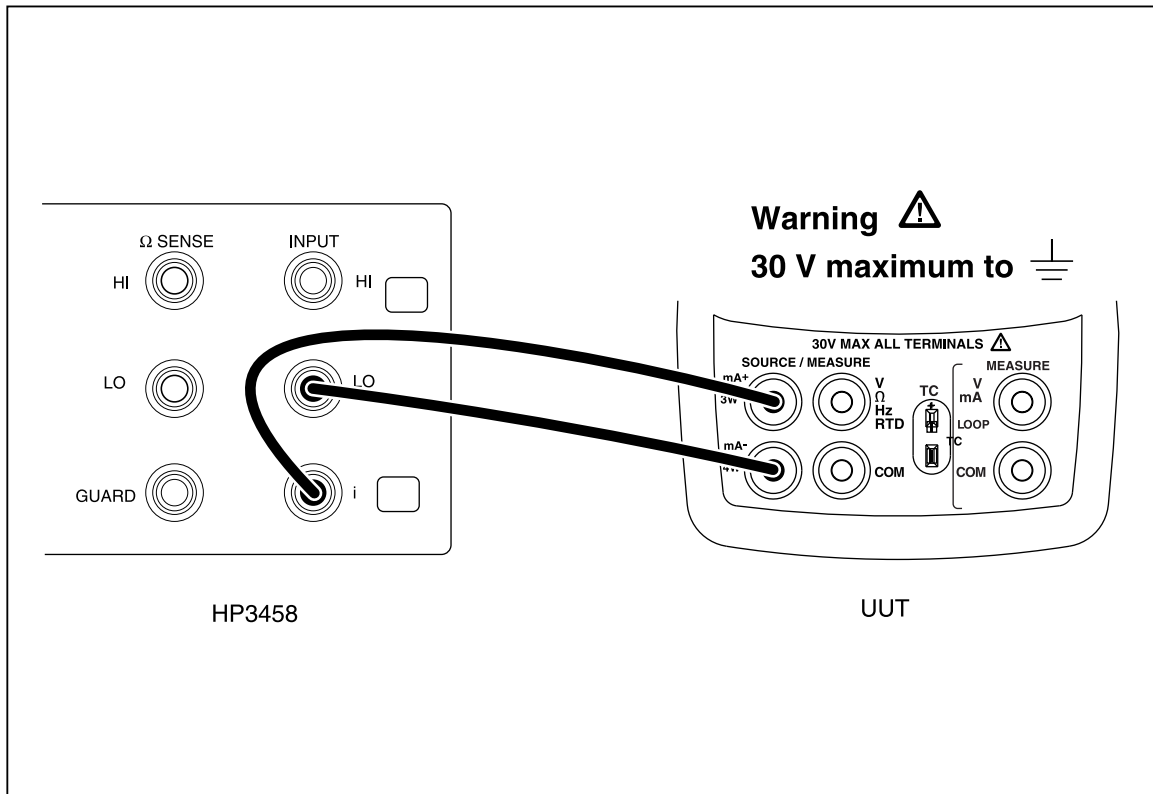

Figure 16. mA Output Calibration Connections

aal12f.eps

From the Calibration Menu, enter the cal step for Cal mA Output. The PC displays:

```
Zero into DAC. Enter mA displayed :
```

Set the HP 3458 to read DC current. Be sure the NPLC on the HP 3458 is slow enough to get stable readings to four decimal places. When the reading on the HP 3458 has stabilized, enter the value in milliamps on the PC, then press Enter. It is only necessary to enter four places past the decimal point. It is not necessary to enter the units (mA). Wait for the following prompt on the PC:

```
Max value into DAC. Enter mA value displayed :
```

Enter the current reading from the HP 3458 in the PC, then press Enter. After a short while, the following calibration constants and new prompt are displayed on the PC:

```
-1.628906 = ( 24.735999 - 0.076400 ) / 65279.00
mA per count = -1.628906
- press space bar to continue
```

Press the space bar to return to the Calibration Menu.

### Cal mV Input

Connect the UUT as shown in Figure 17.

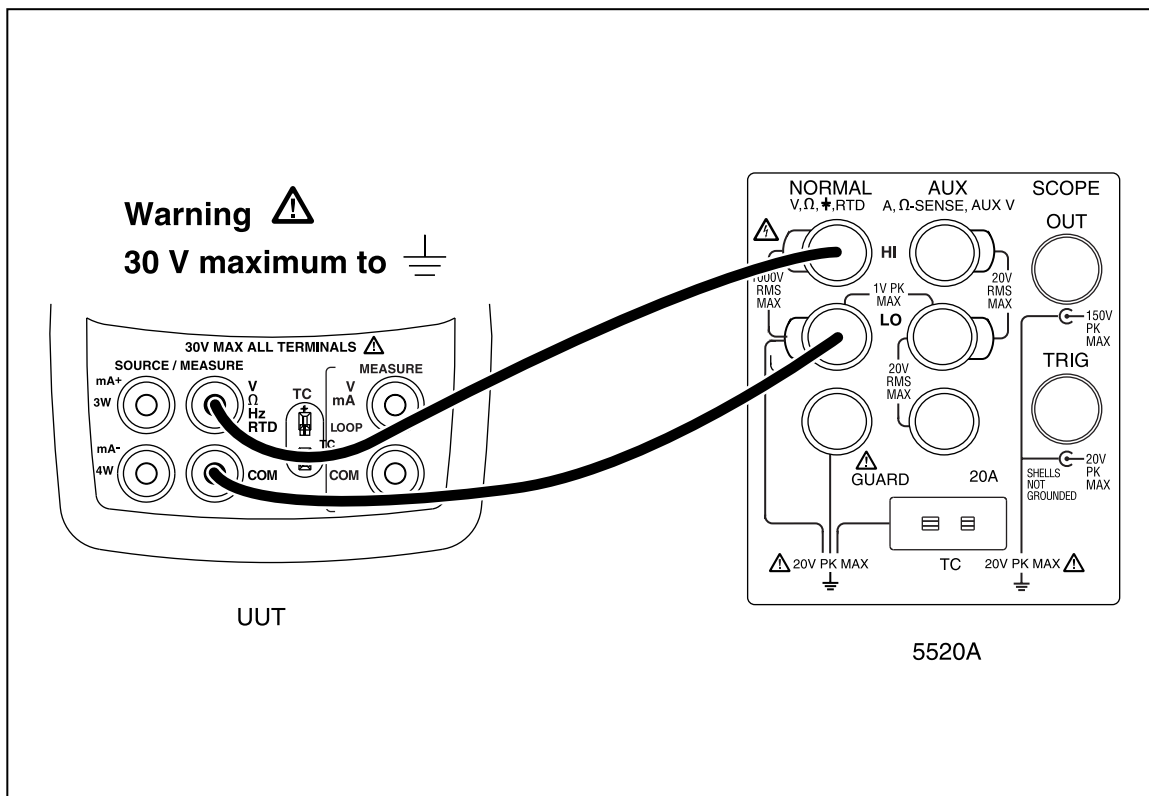

Figure 17. mV Input Calibration Connections

aal04f.eps

From the Calibration Menu, type the number or letter for Cal mV Input. The PC displays:

```
Enter 0 mV - press space bar to continue
```

Set the Fluke 5520A to output 0.000 mV, let the output settle then press the space bar on the PC. After a short while, the PC displays the following calibration constant and new prompt:

```
Offset = -714
Enter 90.00 mV - press space bar to continue
```

Set the Fluke 5520A to output 90.000 mV, let the output settle, then press the space bar on the PC. After a short while, the PC displays the following calibration constants and new prompt:

```
diff = (Counts - Offset)
7513104 = 7512390 - -714
mV per count = 0.000012
-press space bar to continue
```

Press the space bar to return to the Calibration Menu.

### Cal mV Output

Connect the UUT as shown in Figure 18.

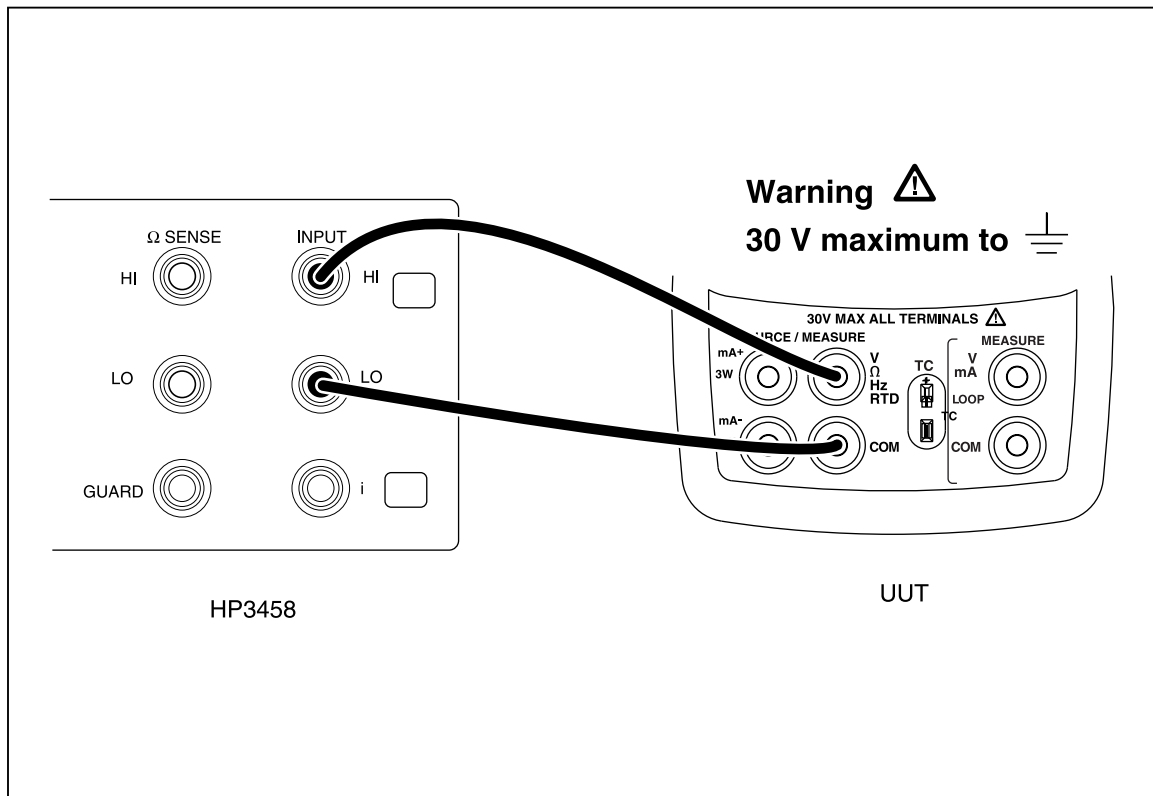

Figure 18. mV Output Calibration Connections

aal08f.eps

From the Calibration Menu, enter the cal step for Cal mV Output. The PC displays:

```
Zero into DAC. Enter mV displayed :
```

Set the HP 3458 to read V DC. Be sure the NPLC on the HP 3458 is slow enough to get stable readings to three decimal places. When the reading on the HP 3458 has stabilized, enter the value in millivolts on the PC, then press Enter. It is only necessary to enter four places past the decimal point. It is not necessary to enter the units (mV). After a short while, the PC displays:

```
Max value into DAC. Enter mV value displayed :
```

Enter the mV reading from the HP 3458 on the PC, press Enter, then press the space bar. After a short while, the PC displays the following calibration constants and new prompt:

```
6537.086487 = 111.874998 - -12.450000 )/ 65279.00 mV per count = 6537.0864
87
- press space bar to continue
```

Press the space bar to return to the Calibration Menu.

## Cal Thermocouples

Connect the UUT as shown in Figure 19.

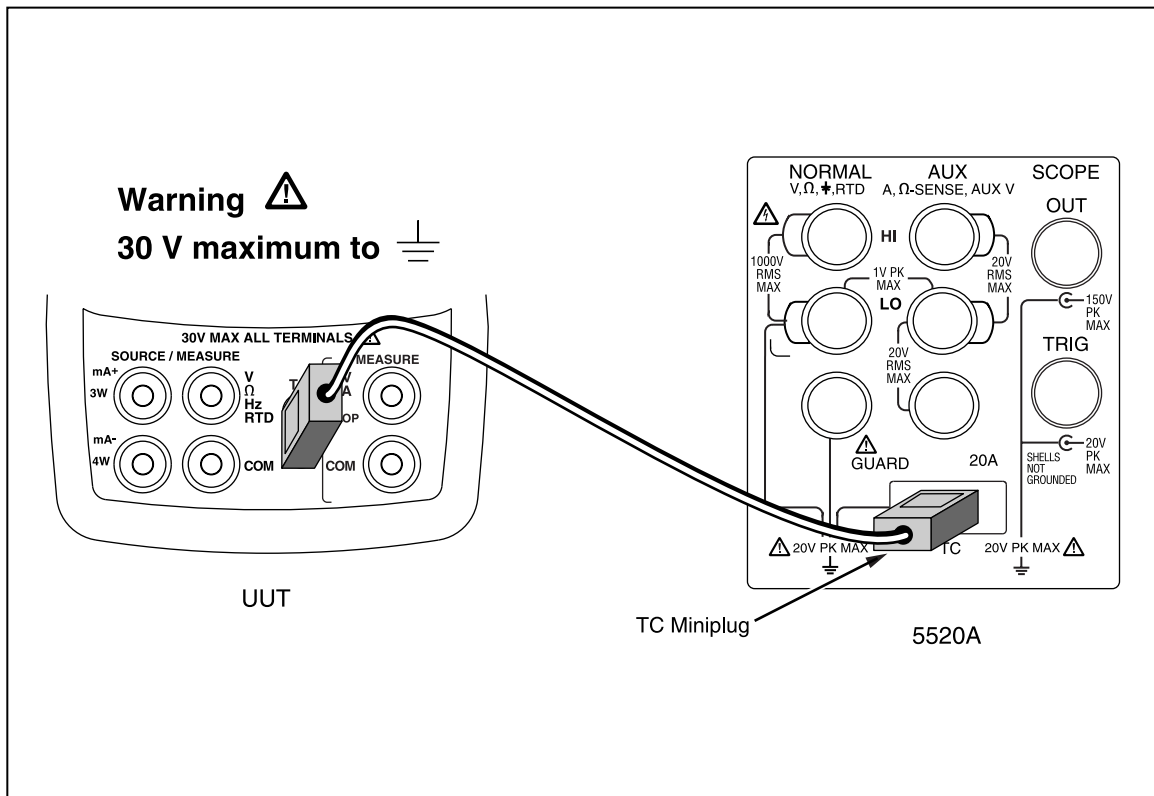

Figure 19. Thermocouples Calibration Connections

aal11f.eps

From the Calibration Menu, enter the cal step for Cal Thermocouples. The PC displays:

```
Connect accurate T/C source : TYPE J thermocouple
Simulate 0.0 degrees C
- press space bar to continue
```

Set the Fluke 5520A to output 0.00 degrees C for a type-J thermocouple using the ITS-90 standard, then press the space bar on the PC. After a short while, the PC displays the following calibration constant and new prompt:

```
CJC Temp Read = 27.359071
Type 2
CJC mV = 1.400393

mV Read = -1.260579

CJC = 0.139814, (cjc - type_j) = 2.736758
- press space bar to continue
```

Press the space bar to return to the Calibration Menu.

### Cal Ohms Hi Source

Connect the UUT as shown in Figure 20.

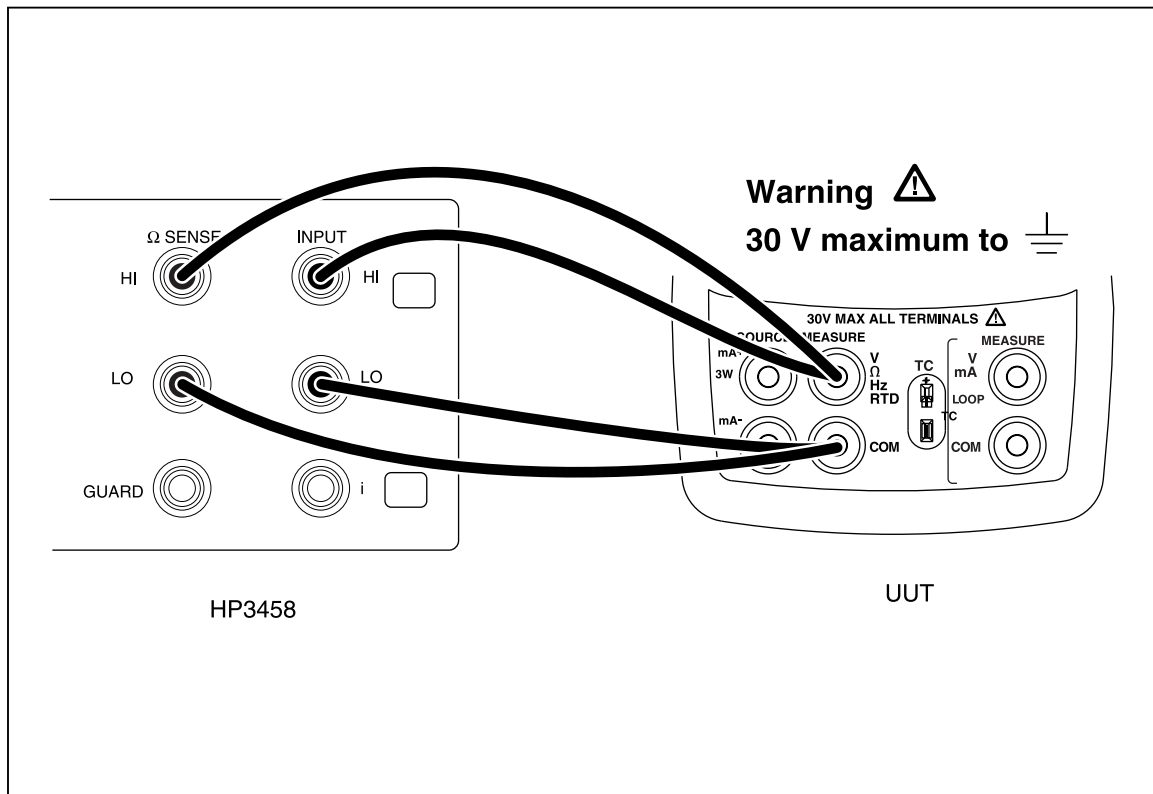

Figure 20. Ohms Hi Source Calibration Connections

aal13f.eps

From the Calibration Menu, enter the cal step for Cal Ohms Hi Source. The PC displays:

```
2500 into DAC. Enter Ohms displayed :
```

Set the HP 3458 to read 4-terminal Ohms. Be sure the NPLC on the HP 3458 is slow enough to get stable readings. When the reading on the HP 3458 has stabilized, enter the value in Ohms on the PC, then press Enter. After a short while, the PC displays:

```
Max value into DAC. Enter Ohms value displayed :
```

Enter the resistance reading from the HP 3458 in the PC, then press Enter. After a short while, the PC displays the following calibration constants and new prompt:

```
0.050685 = 3309.000015 - 0.365000 )/ 65279.00 Ohms per count = 0.050685
- press space bar to continue
```

Press the space bar to return to the Calibration Menu.

### **Cal Ohms Low Source**

The UUT connection is the same as cal Ohms Hi Source, it is shown in Figure 20.

From the Calibration Menu, enter the cal step for Cal Ohms Low Source. The PC displays:

```
2500 into DAC. Enter Ohms displayed :
```

Set the HP 3458 to read 4 terminal Ohms. Be sure the NPLC on the HP 3458 is slow enough to get stable readings. When the reading on the HP 3458 has stabilized, enter the value in Ohms on the PC, then press Enter. After a short while, the PC displays:

```
Max value into DAC. Enter Ohms value displayed :
```

Enter the resistance reading from the HP 3458 in the PC, then press Enter. After a short while, the PC displays the following calibration constants and new prompt:

```
Gain = 0.006910  
y intercept = -57  
= 451.459980 - 17.670000 ) / 65279.00 - press space bar to continue
```

Press the space bar to return to the Calibration menu.

### Cal RTD Low Range

Connect the UUT as shown in Figure 21.

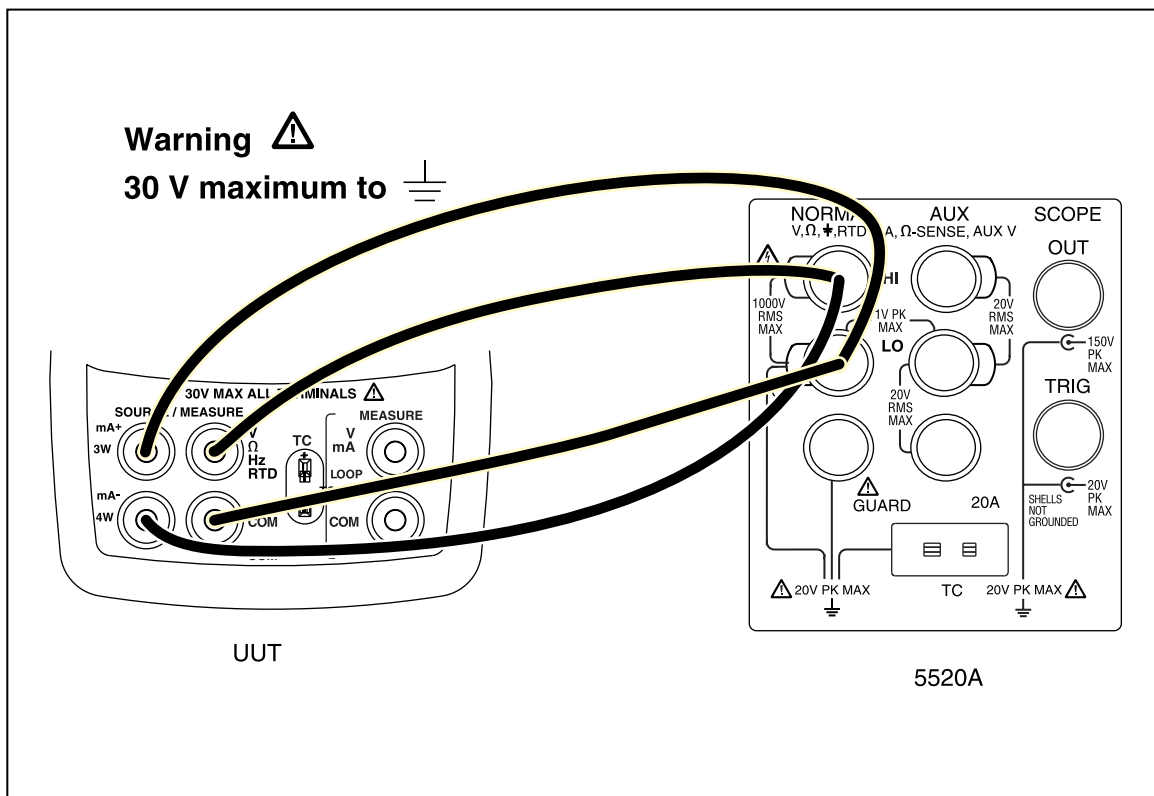

Figure 21. RTD Low Range Calibration Connections

aal09f.eps

From the Calibration Menu, enter the cal step for Cal RTD Low Range. The PC displays:

```
Apply 15 ohms to 4 wire jacks
press space bar to continue
```

Set the Fluke 5520A to output 15.00 Ohms, 2-wire output with 2-wire comp off, then press the space bar on the PC. After a short while, the PC displays:

```
Apply 350 ohms to 4 wire jacks
press space bar to continue
```

Set the Fluke 5520A to output 350.00 Ohms then press the space bar on the PC. After a short while, the Calibrator will return to the Calibration Menu.

### **Cal RTD Hi Range**

The UUT connection is the same as Cal RTD Low Range, it is shown in Figure 21.

From the Calibration Menu, enter the cal step for Cal RTD Hi Range. The PC displays:

```
Apply 500 ohms to 4 wire jacks  
press space bar to continue
```

Set the Fluke 5520A to output 500.0 Ohms, 2-wire output with 2-wire comp off, then press the space bar on the PC. After a short while, the PC displays:

```
Apply 3200 ohms to 4 wire jacks  
press space bar to continue
```

Set the Fluke 5520A to output 3200.0 Ohms, then press the space bar on the PC. After a short while, the Calibrator will return to the Calibration Menu.

**Cal ISO Volts**

Connect the UUT as shown in Figure 22.

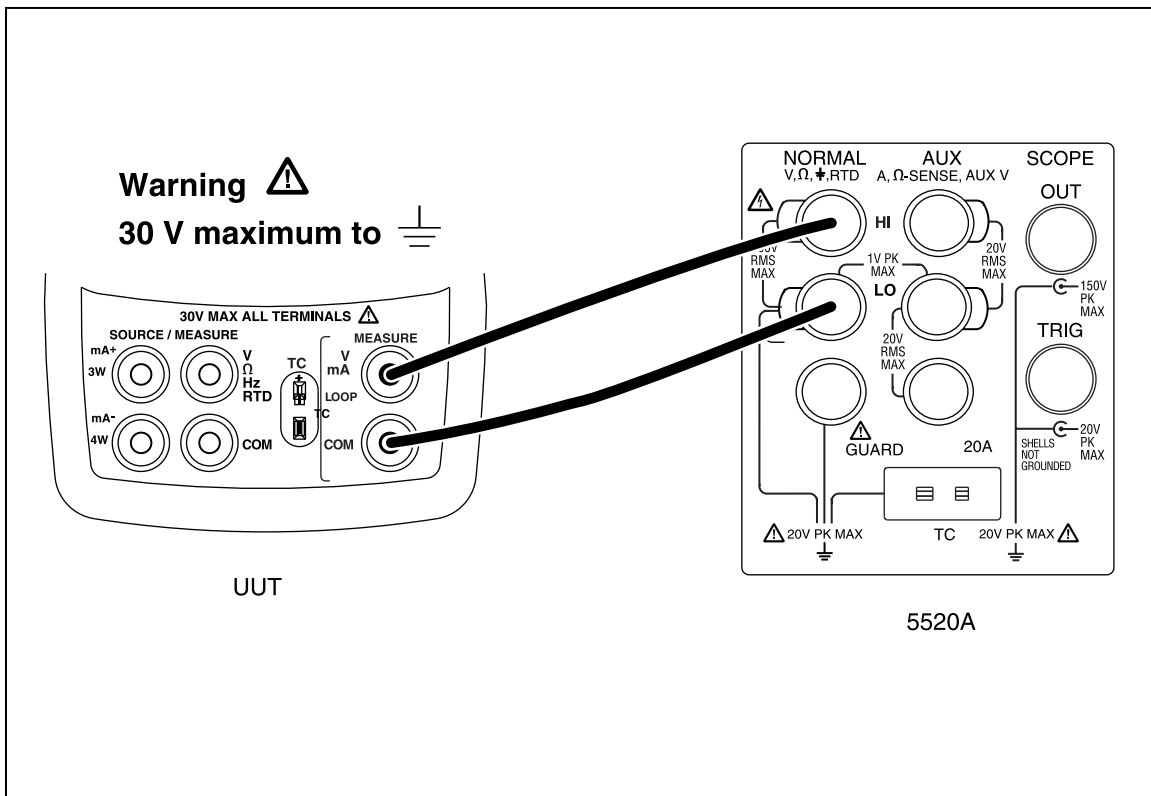

**Figure 22. ISO Volts Calibration Connections**

aal03f.eps

From the Calibration Menu, enter the cal step for Cal ISO Volts. The PC displays:

```
Enter 0 Volts - press space bar to continue
```

Set the Fluke 5520A to output 0.0000 V, then press the space bar on the PC. After a short while the PC displays the following a calibration constant and new prompt:

```
Offset = -324
Enter 30.00 Volts - press space bar to continue
```

Set the Fluke 5520A to output 30.0000 V, then press the space bar on the PC. After a short while, the PC displays the following calibration constants and prompt:

```
diff = (Counts - Offset)
30700 = 30376 - -324
Volts per count = 0.000977
- press space bar to continue
```

Press the space bar to return to the Calibration Menu.

**Cal ISO mA**

Connect the UUT as shown in Figure 23.

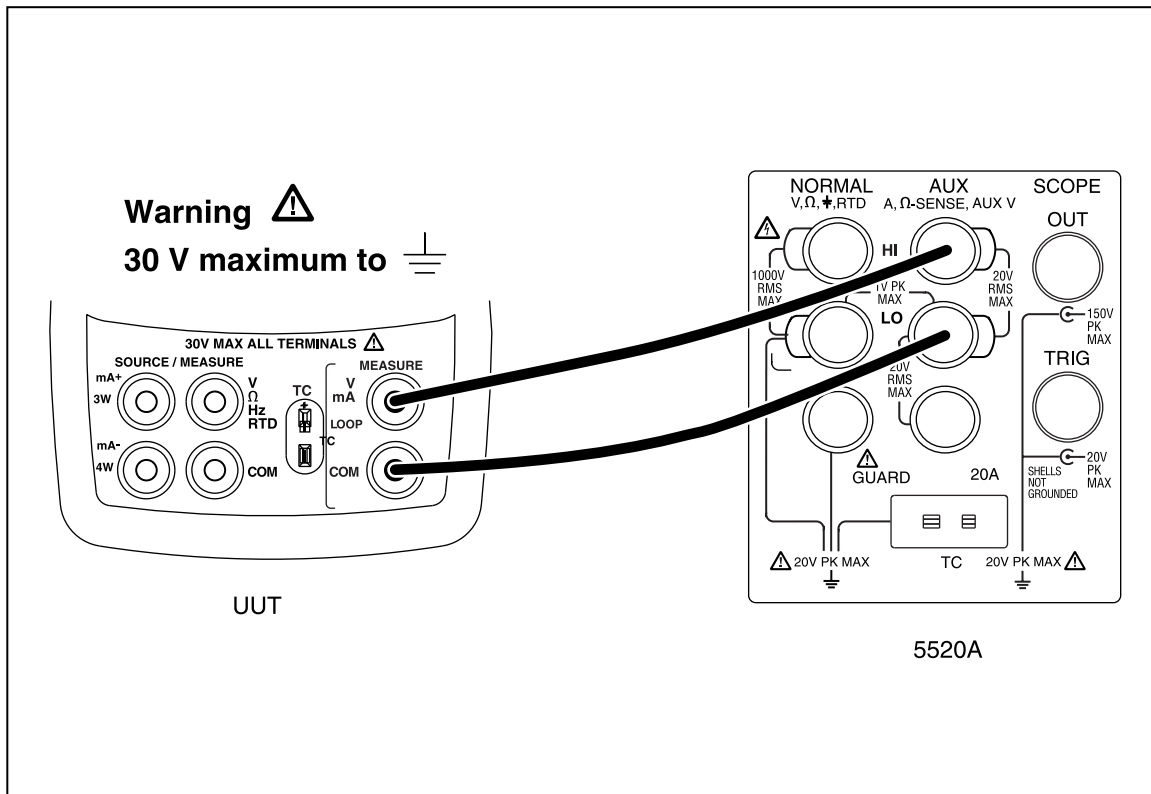

**Figure 23. ISO mA Calibration Connections**

aal05f.eps

From the Calibration Menu, enter the cal step for Cal ISO mA. The PC displays:

```
Enter 0 ma - press space bar to continue
```

Set the Fluke 5520A to output 0.0000 mA. After a short while, the PC displays the following calibration constants and prompt:

```
Offset = -323
Enter 24.00 ma - press space bar to continue
```

Set the Fluke 5520A to output 24.0000 mA then press the space bar on the PC. After a short while, the PC displays the following calibration constants:

```
diff = (Counts - Offset)
32133 = 31810 - -323
mA per count = 0.000747
- press space bar to continue
```

Press the space bar to return to the Calibration Menu.

Adjustment is completed. Turn the UUT off, then back on, to return to normal operation.

## Replaceable Parts

When servicing this Calibrator, use only the replacement parts specified. User-replaceable parts are listed in Table 18.

**Table 18. User Replaceable Parts**

Description	Part Number	Qty.
AA alkaline batteries	See "Table 2. Approved Batteries"	4
Accessory mount	2151981	1
AC72 alligator clip, red	1670641	1
AC72 alligator clip, black	1670652	1
Battery door	2097832	1
Battery Door Screws	2418054	1
Fluke 725Ex CD ROM, contains <i>Fluke 725Ex User Manual</i>	2406548	1
<i>Fluke 725Ex Control Drawing</i>	6800032	1
<i>Fluke 725Ex Safety Information</i>	2151996	1
<i>Fluke 725Ex Calibration Manual</i>	2406553	1
Input Decal	2395420	1
Test lead, red	688051	1
Test lead, black	688066	1
Tilt stand	2097826	1
TL75 series test leads	855742	1



# Manual Supplement

Manual Title:	725Ex Calibration	Supplement Issue:	1
Part Number:	2406553	Issue Date:	3/05
Print Date:	January 2005	Page Count:	1
Revision/Date:			

---

---

This supplement contains information necessary to ensure the accuracy of the above manual. Enter the corrections in the manual if either one of the following conditions exist:

1. The revision letter stamped on the indicated PCA is equal to or higher than that given with each change.
2. No revision letter is indicated at the beginning of the change.

## Change #1

On page 8, under **General Specifications, Product Compliance**, change the following:

From: **CE**                       II 1 G EEx ia [ia] IIB 171 °C  
0344                      KEMA 04ATEX1303X

                      Class I Div. 1 Groups B,C, and D  
**LR110460**                      Class I Zone 0 Aex/Ex ia [ia] IIB 171 °C  
2004.1573226

To: **CE**                       II 1 G EEx ia IIB 171 °C  
0344                      KEMA 04ATEX1303X

                      Class I Div. 1 Groups B,C, and D  
**LR110460**                      Class I Zone 0 Aex/Ex ia IIB 171 °C  
2004.1573226