

Datasheet

2.00mm SIL Crimp Socket Housing

RS Stock number 842-719

Dimensions - mm

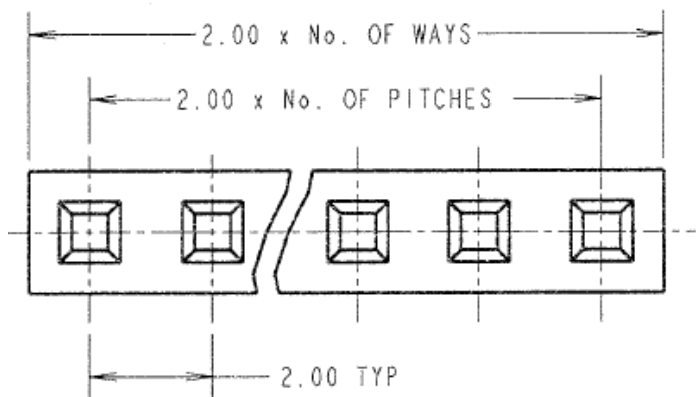
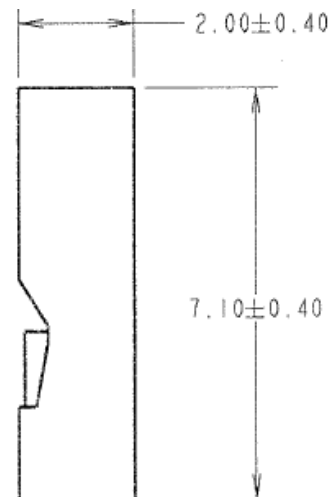
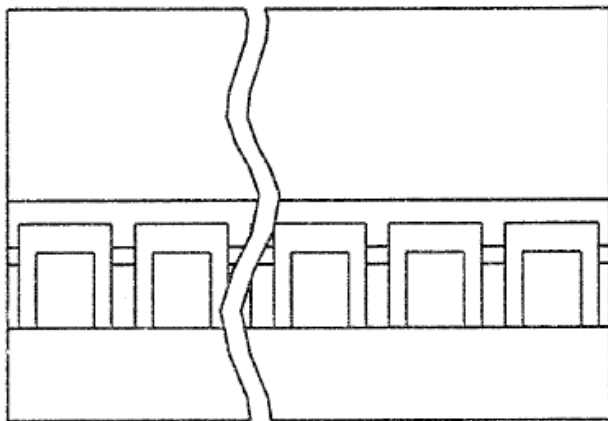

Specifications:

Moulding:	Nylon 66 UL94V-2, Black
Current Rating:	2A
Contact Resistance (initial):	10 milliohms max.
Contact Resistance (after conditioning):	20 milliohms max.
Insulation Resistance:	5000 megohms min.
Operating Temperature:	-40°C to 105°C