

MASTER LEDspot LV

MASTER LEDspotLV D 7-40W 830 MR16 36D



Delivering a warm, halogen-like accent beam, MASTER LEDspot LV is an ideal retrofit solution for spot and general lighting applications in the hospitality industry. It is particularly suited to public areas such as receptions, lobbies, corridors, stairwells and washrooms, where the light is on all the time. The robustly designed MASTER LEDspot offers a choice of beam angles for a clearly defined beam spread. There is no UV or IR in the beam, making it suitable for illuminating heat-sensitive objects (food, organic materials, paintings, etc.). The patented intelligent driver enables broad compatibility with existing electromagnetic and electronic halogen transformers. The dimmable versions drive further efficiencies, while helping to create the desired atmosphere.

Product data

• General Characteristics

Cap-Base	GU5.3
Bulb	MR16 [MR 16inch/50mm]
Rated Lifetime	40000 hr
Nominal Lifetime hours	40000 hr

• Light Technical Characteristics

Colour Code	830
Colour Designation	White
Beam Angle	36 D
Beam Description	36D [Medium beam]
Correlated Colour Temperature	3000 K
Luminous Flux	510 Lm
Luminous Intensity	1350 cd
Colour rendering index	80
Luminous Efficacy Lamp	72.86 Lm/W
Colour Temperature	3000 K [CCT 3000K]
Rated Luminous Flux	510 Lm
LLMF - end nominal lifetime	70 %
Colour consistency	6 steps
Rated Beam Angle	36 D
Luminous flux in 90° cone	470 Lm

• Electrical Characteristics

Wattage	7 W
Wattage Technical	7 W
Voltage	12 V
Line Frequency	50-60 Hz
Power Factor	0.8 -

Lamp Current mA	715 mA
Dimmable	Yes
Wattage Equivalent	40 W
Rated Wattage	7.0 W
Starting Time	0.5 (max) s
Warm-up Time to 60% Light Outp	instant full light
Suitable for accent lighting	Yes

• Temperature Characteristics

T-case maximum	110 C
----------------	-------

• Environmental characteristics

Energy Efficiency Label (EEL)	A+
-------------------------------	----

• Measuring Conditions

Switching cycle	50000X
-----------------	--------

• Product Dimensions

Overall Length C	54 mm
Diameter D	50 mm

• Product Data

Order code	741411 00
Full product code	871829174141100
Full product name	MASTER LEDspotLV D 7-40W 830 MR16 36D
Order product name	MAS LEDspotLV D 7-40W 830 MR16 36D
Pieces per pack	1



PHILIPS

MASTER LEDspot LV

Packing configuration 10
Packs per outerbox 10
Bar code on pack - EAN1 8718291741411
Bar code on outerbox - EAN3 8718291741428

Logistic code(s) - 929000263402
12NC
Net weight per piece 0.060 kg

Warnings and Safety

- Operating temperature range is between -20° C and 45° C ambient

- Only to apply in dry or damp locations and most of open fixtures with lamp-holders that offer sufficient space (10 mm free air space)
- Not intended for use with emergency light fixtures or exit lights

Dimensional drawing

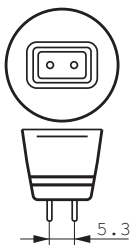
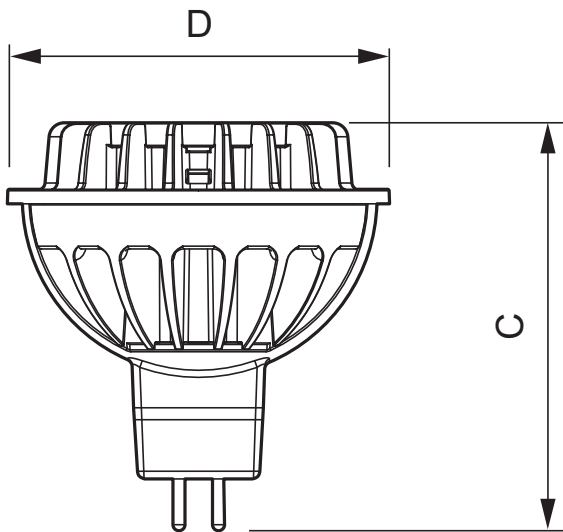

GU5.3

MASTER LEDspotLV D 7-40W 830 MR16 36D

Product	C (Norm)	C1 (Max)	D (Norm)	D1 (Norm)
LED D 7-40W 830 MR16 36D	54	-	50	-

Photometric data

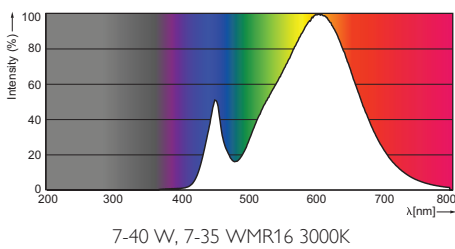



© 2014 Koninklijke Philips N.V. (Royal Philips)
All rights reserved.

Specifications are subject to change without notice. Trademarks are the property of Koninklijke Philips N.V. (Royal Philips) or their respective owners.

www.philips.com/lighting

2014, June 6
data subject to change