



ENGLISH

Datasheet

AC Axial Fan

RS Stock number 619-6977



Frame

Diecast Aluminium

Impeller

PBT, UL94V-0 Thermoplastic

Finger Guard: G80 – 18

Plastic Guard: G80P

Aluminium Filter: WMG80M

Filter Kit- GRM80-30, GRM80-45

Specifications:

RS Part Number	Orion Part Number	Speed (RPM)	Airflow (CFM)	Noise (db)	Volts (AC)	Voltage Range	Watts	Connection Type
6196983	OA80AP-11-1TB	3000	31	36	115	80~130	12	Terminal
6196977	OA80AP-11-1TB(20)*	3000	31	36	115	80~130	12	Terminal
6196999	OA80AP-11-1WB	3000	31	36	115	80~130	12	Lead Wire
6197015	OA80AP-22-1TB	3000	31	36	230	160~260	12	Terminal
6197009	OA80AP-22-1WB	3000	31	36	230	160~260	12	Lead Wire

*(20): Indicates Environmentally Protective Coating

Data Tolerance +/- 10%



Specifications:

Motor

Shaded Pole
Impedance Protected

Dielectric Strength

1 minute at 1500 V ac, 50/60 Hz

Life Expectancy (L10)

Ball Bearing 60,000 hours

Operating Temperature

-20C ~ +80C

Safety Approvals

UL/CUL, TUV, CE

Dimensions (mm):

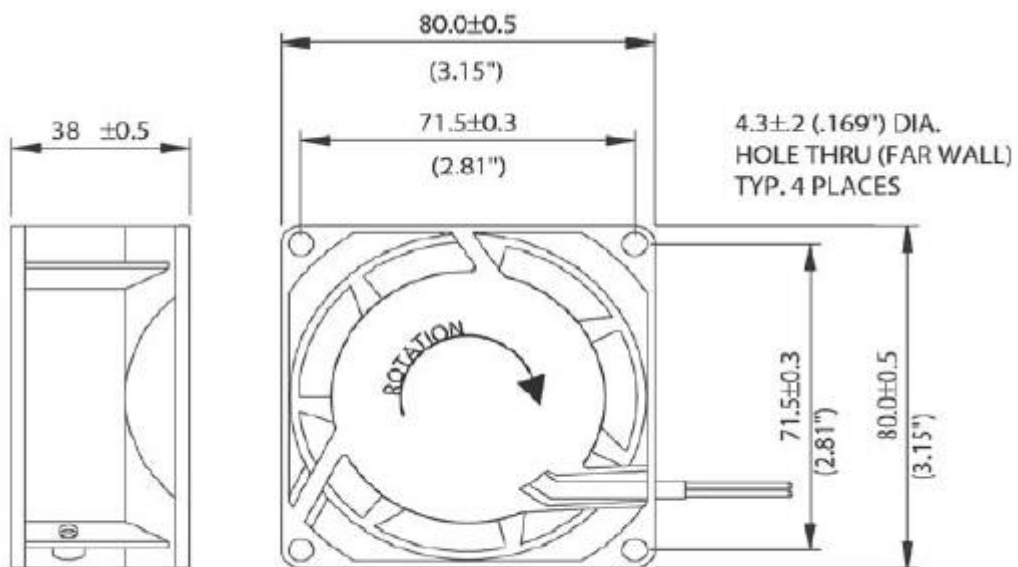

*Drawing for Dimensional Reference Only