

# iVu Plus TG Image Sensor



## Datasheet

### iVu Plus Image Sensor With Integrated Display

The iVu image sensor is used to monitor parts for type, size, orientation, shape, and location. The iVu Plus TG package consists of lighting, sensor, lens, and display. This version of the iVu Plus has an integrated display to set up and monitor inspections. Cables and mounting brackets can be ordered for each application. Additionally, other lenses, filters, and external lights are available.

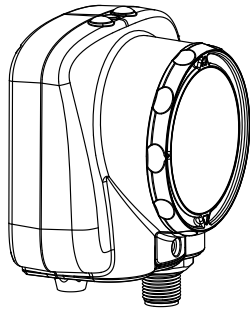

#### Features

- No PC required to configure the sensor
- Image processing expertise is not required
- Multiple inspections that facilitate storing and controlling up to 30 inspections for fast product turnover
- Each inspection can store multiple sensors to enable multiple features inspection.
- Four sensor types in one package—a match sensor that determines whether a pattern on a label or part matches a reference pattern; a sort sensor that can recognize and sort up to ten different patterns within the same inspection; an area sensor that detects whether or not a particular feature (or features) is present; and a blemish sensor that detects flaws on parts
- USB port for uploading and downloading of inspections and log files for easy updating and diagnostics
- Integrated color touch screen display
- Ethernet communications for communication with the sensor
- A RS-232 serial communications port
- High speed processing



#### WARNING: Not To Be Used for Personnel Protection

Never use this device as a sensing device for personnel protection. Doing so could lead to serious injury or death. This device does not include the self-checking redundant circuitry necessary to allow its use in personnel safety applications. A sensor failure or malfunction can cause either an energized or de-energized sensor output condition.

## Models

Ring Light Options	Micro Video Lens Options						C-Mount Lens Options
	4.3 mm	6 mm	8 mm	12 mm	16 mm	25 mm	
None	IVUPTGX04	IVUPTGX06	IVUPTGX08	IVUPTGX12	IVUPTGX16	IVUPTGX25	IVUPTGXC
Red	IVUPTGR04	IVUPTGR06	IVUPTGR08	IVUPTGR12	IVUPTGR16	IVUPTGR25	N/A
Blue	IVUPTGB04	IVUPTGB06	IVUPTGB08	IVUPTGB12	IVUPTGB16	IVUPTGB25	N/A
Green	IVUPTGG04	IVUPTGG06	IVUPTGG08	IVUPTGG12	IVUPTGG16	IVUPTGG25	N/A
IR	IVUPTGI04	IVUPTGI06	IVUPTGI08	IVUPTGI12	IVUPTGI16	IVUPTGI25	N/A
White	IVUPTGW04	IVUPTGW06	IVUPTGW08	IVUPTGW12	IVUPTGW16	IVUPTGW25	N/A
UV 365 <sup>1</sup>	IVUPTG604	IVUPTG606	IVUPTG608	IVUPTG612	IVUPTG616	IVUPTG625	N/A
UV 395 <sup>1</sup>	IVUPTG904	IVUPTG906	IVUPTG908	IVUPTG912	IVUPTG916	IVUPTG925	N/A



NOTE: This product emits UV light. Exempt Risk Group (RG 0) product. No optical hazard is considered reasonably foreseeable, even for continuous, unrestricted use (IEC 62471).

<sup>1</sup> Blue Filter Kit (FLT B) included with UV models.

## Specifications

### Power Connection

12-pin Euro-style (M12) male connector; accessory cable required for operation

### USB 2.0 Host

4-pin Pico (M8) female connector; optional USB cable required for operation of USB flash drive

### Ethernet Connection

4-pin Pico (M8) male connector

### Power Requirements

Voltage: 10 to 30 V dc

Current: 1 A maximum (exclusive of I/O load)

### Output Configuration

NPN or PNP, software selectable

### Demo Mode

Full tool functionality on canned images

### Sensor Lock

Optional password protection

### Integrated Ring Light

Models with Red, IR, Green, Blue, White or no integrated ring light

### Output Rating

150 mA

### External Strobe Output

+ 5 V dc

### Acquisition

98 fps (frames per second)<sup>2</sup>

### Exposure Time

0.1 ms to 1.049 s

### Imager

1/3 inch CMOS 752 × 480 pixels; adjustable Field of View (FOV)

### Lens Mount

Micro Video Lens models: M12 × 1 mm thread; micro video lens 4.3, 6, 8, 12, 16, 25 mm

C-Mount models: Standard C-mount (1 inch-32 UN)

### Construction

Black Valox™ sensor housing; acrylic window

Weight: 0.37 kg (0.82 lbs)

### Environmental Rating

IP67

### Operating Conditions

Stable Ambient Temperature: 0 °C to +45 °C (+32 °F to +113 °F)

### Certifications



## Dimensions

### Micro Video Lens Dimensions

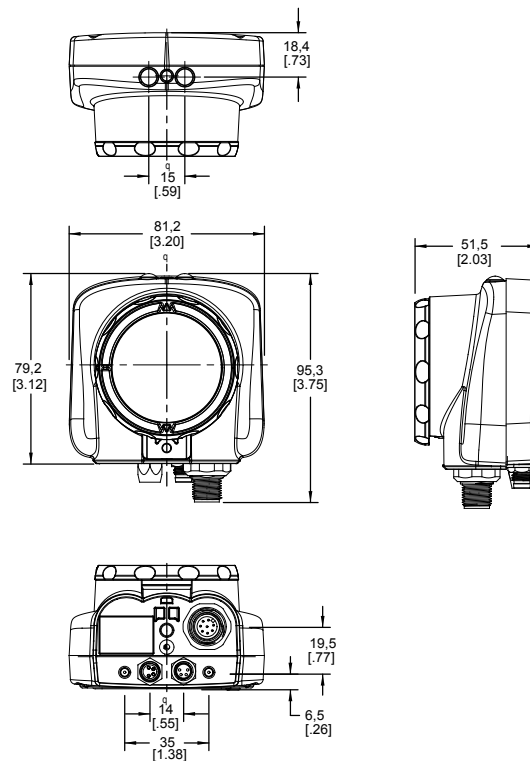

<sup>2</sup> This value can vary based on inspection settings.

C-Mount Lens Dimensions

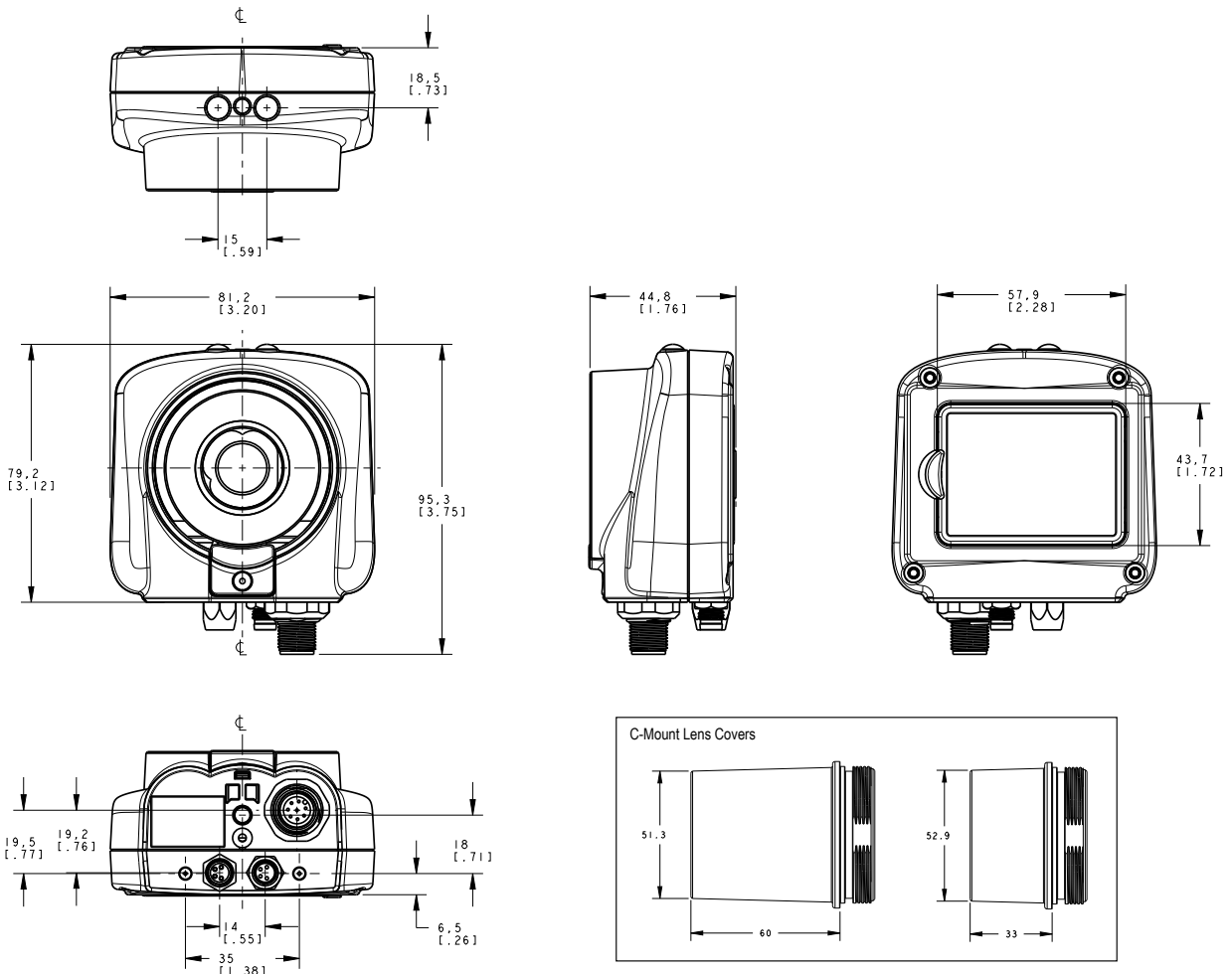

## Cable Connections for Integrated Display

The cable connections on the iVu Plus with integrated display are shown below, and power I/O connections (C) are defined in the Power I/O Connections table below.

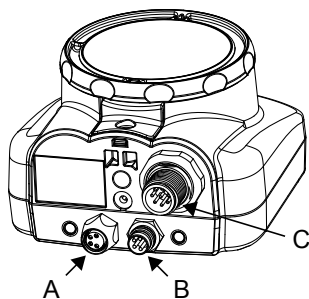

- A USB Connector
- B Ethernet Connector
- C Power I/O Connector



NOTE: Micro video lens model shown, C-Mount model connections are identical.

Power I/O Connections			
Pin #	Wire Color	Description	Direction
1	White	Output 1	Output
2	Brown	10-30V dc	Input
3	Green	Output 2	Output
4	Yellow	Strobe Out (5V dc only)	Output
5	Gray	Remote Teach	Input
6	Pink	External Trigger	Input
7	Blue	Common (Signal Ground)	Input
8	Red	Ready	Output
9	Orange	Output 3	Output
10	Light Blue	RS-232 TX	Output
11	Black	RS-232 Signal Ground	Output
12	Violet	RS-232 Rx	Input

## iVu Trigger, Remote Teach, and I/O Waveforms

The iVu has two input signals—Trigger and Remote Teach. The default setting is to detect the low to high transition. This setting can be changed in the Main Menu > System > Discrete I/O > Input Polarity screen on the sensor.

### PNP (Low-to-High) Trigger and Remote Teach Input Waveforms

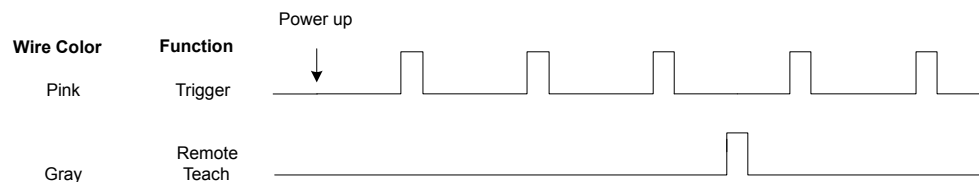

The sensor triggers from low to high, and Remote Teach behaves electrically like trigger.

### NPN (High-to-Low) Trigger and Remote Teach Input Waveforms

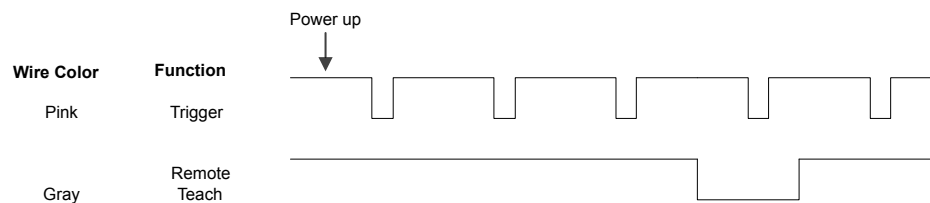

The sensor triggers from high to low, and Remote Teach behaves electrically like trigger.



**NOTE:** If the device used to trigger or remote teach the iVu Plus TG is a sinking device, these are the options regarding the use of a pull-up resistor:

Option 1: Put a pull-up resistor, rated approximately 1k ohm, between the sensor's positive (+) voltage and the sensor's input as shown below.

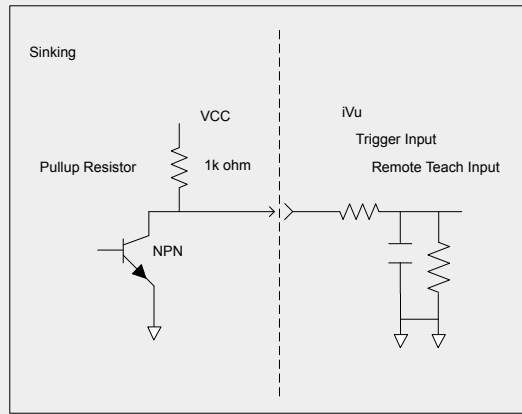

Option 2: Enable the Input Pullup in the iVu Plus TG software (Main Menu > System > Discrete I/O > Input Pullup).

## iVu Output Waveforms

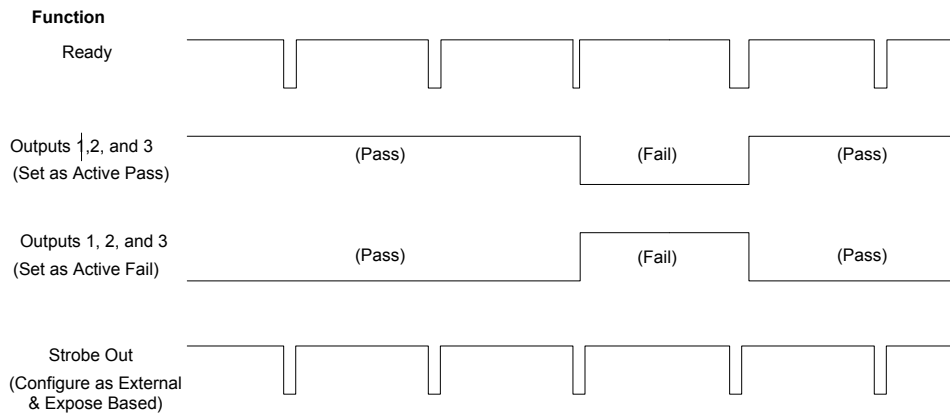

Figure 1. PNP Outputs

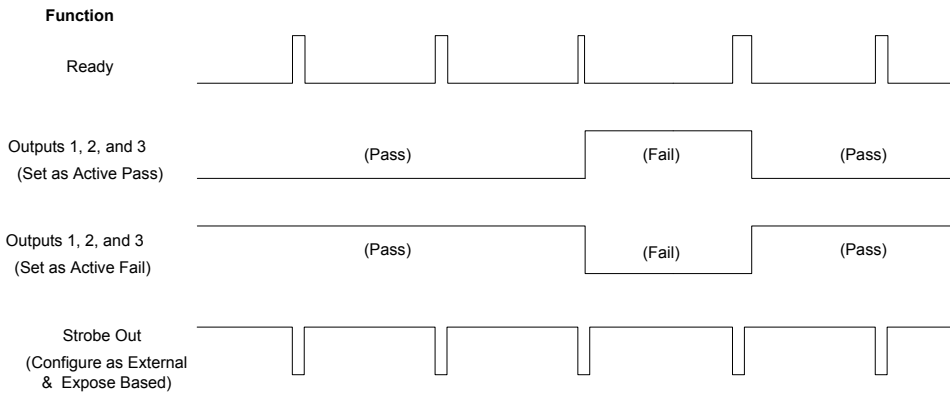
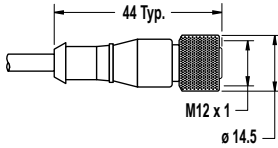
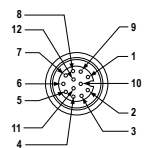
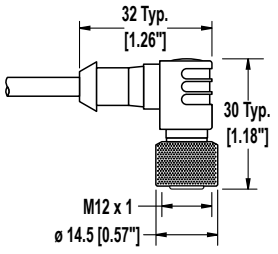

Figure 2. NPN Outputs

## Accessories

### Power Cable — Required

12-Pin M12/Euro-Style Cordsets				
Model	Length	Style	Dimensions	Pinout
iVUC-1206	1.83 m (6 ft)	Straight		 1 = White 2 = Brown 3 = Green 4 = Yellow 5 = Gray 6 = Pink 7 = Blue 8 = Red 9 = Orange 10 = Lt. Blue 11 = Black 12 = Violet
iVUC-1215	4.57 m (15 ft)			
iVUC-1230	9.14 m (30 ft)			
iVUC-1250	15.2 m (50 ft)			
iVUC-1275	22.9 m (75 ft)			
iVUC-1206RA	1.83 m (6 ft)	Right-Angle		
iVUC-1215RA	4.57 m (15 ft)			
iVUC-1230RA	9.14 m (30 ft)			
iVUC-1250RA	15.2 m (50 ft)			
iVUC-1275RA	22.9 m (75 ft)			

### Ethernet Cable Options

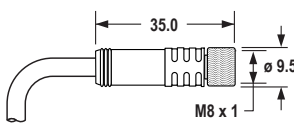
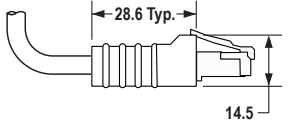
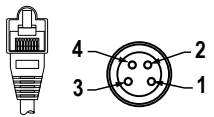
RJ45 Ethernet to 4-Pin Threaded M8/Pico-Style Cordsets				
Model	Length	Style	Dimensions	Pinout
IVUC-E-406	1.83 m (6 ft)	Cat5e Shielded	 	 1 = Blue 2 = White/Blue 3 = White/Orange 4 = Orange
IVUC-E-415	4.57 m (15 ft)			
IVUC-E-430	9.14 m (30 ft)			
IVUC-E-450	15.2 m (50 ft)			
IVUC-E-475	22.9 m (75 ft)			

### USB Cable — Optional

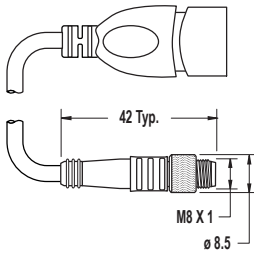
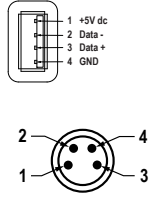
4-Pin Threaded M8/Pico-Style to USB Cordsets with Shield—Double Ended				
Model	Length	Style	Dimensions	Pinout
PSG-4M-4005-USB	0.15 m (6 in)	Straight Pico QD/ USB		 1 = Red 2 = White 3 = Black 4 = Green
PSG-4M-401-USB	0.31 m (1 ft)			
PSG-4M-403-USB	0.91 m (3 ft)			
PSG-4M-410-USB	3.0 m (10 ft)			
PSG-4M-416-USB	4.9 m (16 ft)			

## USB Flash Drive — Optional

Model	Description
IVU-USBFD2	USB Flash Drive 2 GB

## Brackets

### SMBIVUB

- Bottom mounting bracket
- Black anodized aluminum
- Hardware included

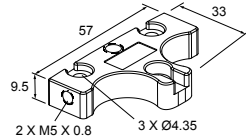

### SMBIVURAL

- Right-angle bracket for mounting sensor from the left
- 12-ga. stainless steel
- Hardware included

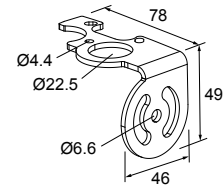

### SMBIVURAR

- Right-angle bracket for mounting sensor from right
- 12-ga. stainless steel
- Hardware included

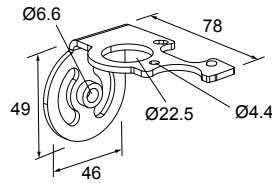

### SMBIVUU

- U-shaped swivel bracket kit
- 14-ga. stainless steel
- Hardware included

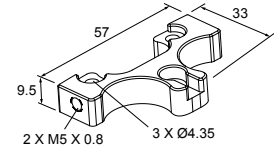

NOTE: Use cables with right-angle connectors with this bracket kit.

## Micro Video Lens Accessories

### Micro Video Lens Models

Model	Lens Description
LMFO4 <sup>3</sup>	4.3 mm lens
LMFO6	6 mm lens
LMFO8	8 mm lens
LMF12	12 mm lens
LMF16	16 mm lens
LMF25	25 mm lens

## Micro Video Lens Filters — Optional

Model	Description
FLTMR	Red filter kit
FLTMB	Blue filter kit
FLTMG	Green filter kit
FLTMI	IR filter kit

<sup>3</sup> Due to the flexibility of the replaceable lenses, focus mechanism, and imager field-of-view settings, it is possible with the 4.3 mm lens to experience reflections from the internal strobe on the inspection image. To eliminate this effect, the field-of-view can be limited to the system default of 320×240 (or 640×480 for fine), the working distance to the object should be no more than about 8 inches, or an external strobe should be used instead of the internal ring light.

## C-Mount Lens Accessories

### C-Mount Lens Models

Model	Lens Description
LCF04	4 mm Lens - no threads for filter
LCF08	8 mm Lens - no threads for filter
LCF12	12 mm Lens - no threads for filter
LCF16	16 mm Lens, aperture lock - no threads for filter
LCF25R	25mm lens
LCF25LR	25mm lens with focus locking
LCF50L1R	50mm lens with focus locking, plastic
LCF50L2R	50mm lens with focus locking, metal (will not fit ring)
LCF75LR	75mm lens with focus locking, metal (will not fit ring)

### C-Mount Lens Enclosure Models

Model	Description
IVUSLC50-P	Sealed C-mount lens enclosure
IVUSLC75-P	

### C-Mount Lens Filters — Optional

Model	Description
FLTR	Red filter kit
FLTB	Blue filter kit
FLTG	Green filter kit
FLTI	IR Filter kit

## Banner Engineering Corp Limited Warranty

Banner Engineering Corp. warrants its products to be free from defects in material and workmanship for one year following the date of shipment. Banner Engineering Corp. will repair or replace, free of charge, any product of its manufacture which, at the time it is returned to the factory, is found to have been defective during the warranty period. This warranty does not cover damage or liability for misuse, abuse, or the improper application or installation of the Banner product.

THIS LIMITED WARRANTY IS EXCLUSIVE AND IN LIEU OF ALL OTHER WARRANTIES WHETHER EXPRESS OR IMPLIED (INCLUDING, WITHOUT LIMITATION, ANY WARRANTY OF MERCHANTABILITY OR FITNESS FOR A PARTICULAR PURPOSE), AND WHETHER ARISING UNDER COURSE OF PERFORMANCE, COURSE OF DEALING OR TRADE USAGE.

This Warranty is exclusive and limited to repair or, at the discretion of Banner Engineering Corp., replacement. IN NO EVENT SHALL BANNER ENGINEERING CORP. BE LIABLE TO BUYER OR ANY OTHER PERSON OR ENTITY FOR ANY EXTRA COSTS, EXPENSES, LOSSES, LOSS OF PROFITS, OR ANY INCIDENTAL, CONSEQUENTIAL OR SPECIAL DAMAGES RESULTING FROM ANY PRODUCT DEFECT OR FROM THE USE OR INABILITY TO USE THE PRODUCT, WHETHER ARISING IN CONTRACT OR WARRANTY, STATUTE, TORT, STRICT LIABILITY, NEGLIGENCE, OR OTHERWISE.

Banner Engineering Corp. reserves the right to change, modify or improve the design of the product without assuming any obligations or liabilities relating to any product previously manufactured by Banner Engineering Corp.