

MD-45 AC  
MD-45 LV

# INSTALLATIONSANVISNING INSTALLATION MANUAL INSTALLATIONS ANLEITUNG MANUEL D'INSTALLATION

6157-2001

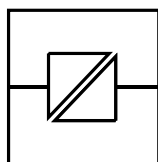

Galvanic  
Isolation

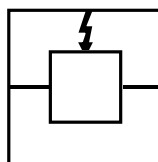

Transient  
Protection

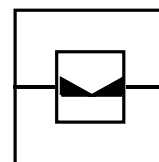

Balanced  
Transmission

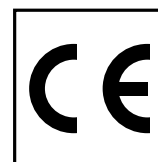

CE  
Approved

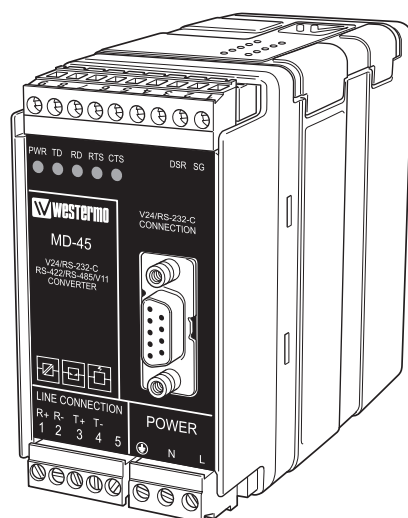

***Omvandlare RS-232 – RS-422/485  
Converter RS-232 – RS-422/485  
RS-232 – RS-422/485 Wandler  
Convertisseur RS-232-RS-422/485***

 **westermo**<sup>®</sup>

[www.westermo.se](http://www.westermo.se)

<sup>®</sup>  
**WESTERMO**

## Specifikationer MD-45

<b>Överföring</b>	Asynkront, full/halv duplex eller simplex
<b>Gränssnitt 1</b>	EIA RS-232-C/ITU-T V.24 9-polig D-sub, hylsa eller 9-polig skruvplint
<b>Gränssnitt 2</b>	EIA RS-422/RS-485/ITU V.11, 5-polig skruvplint
<b>Överföringshastighet</b>	1 200 bit/s – 115,2 kbit/s
<b>Lysdioder</b>	Power, RD, CTS, RTS, TD
<b>Temperaturområde</b>	5–50°C, omgivningstemperatur
<b>Fuktighetsområde</b>	0–95% RH, utan kondensation
<b>Mått</b>	55x100x128 mm (BxHxD)
<b>Vikt</b>	0,5 kg AC / 0,25 kg LV
<b>Montering</b>	På 35 mm DIN-skena
<b>Matningsalternativ</b>	

Modelbeteckning	MD-45 AC	MD-45 115 V AC	MD-45 LV
Strömförsörjning	230 V AC +15/–10%	115 V AC +15/–10%	12–45 V AC +15/–10%
Frekvens	48–62 Hz	48–62 Hz	12–60 V DC
Säkring, FI	100 mA S 5x20 mm Littlefuse	100 mA S 5x20 mm Littlefuse	1 A T 5x20 mm Wickmann
Effektförbrukning	22 mA	44 mA	2 W
Transientskydd Matning/Linje	Ja/Ja	Ja/Ja	–/Ja
Isolation RMS Strömförsörjning Linje	3 000 V 1 500 V	3 000 V 1 500 V	3 000 V 1 500 V

## Inställningar MD-45

MD-45 kan genom inställningar anpassas till ett flertal olika driftförhållanden.







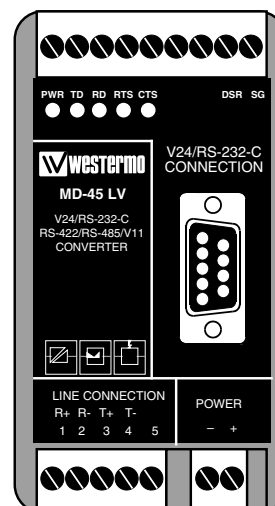
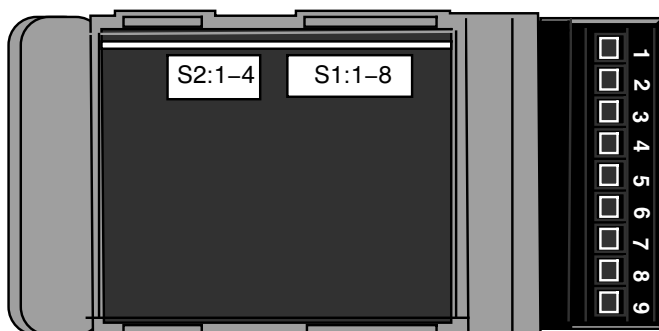

Samtliga omkopplare i MD-45 är åtkomliga när lådans lock avlägsnas.

Locket avlägsnas med ett enkelt handgrepp.



## Varning! Öppna ej ansluten enhet





## Val av hastighet

	Hastighet	Vändtid
SI 	1 200	780 µs
SI 	2 400	410 µs
SI 	4 800	220 µs
SI 	9 600	130 µs
SI 	19 200	48 µs
SI 	38 400	34 µs
SI 	57 600	22 µs
SI 	115 200	11 µs

## Data eller RTS-styrning





SI 	Datastyrning
SI 	RTS-styrning

## Fabriksinställning

SI 
S2 

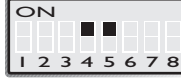
SI: 8 används ej



## Val av antal bitar

SI 	9
SI 	10
SI 	11
SI 	12

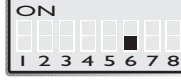
## 2/4-tråds överföring

SI 	2-tråd
SI 	4-tråd

## Terminering med fail-safe \*

S2 	Terminerad (4-tråd)
S2 	Terminerad (2-tråd)
S2 	Ingen terminering

\* Fail-safe funktionen gör att mottagaren alltid uppfattar signaltillståndet OFF då inkopplad sändare har tillståndet tri-state (sändare ej aktiverad). Terminering skall kopplas in på mottagaren belägen längst bort från sändaren.

Hjälpställning för inställning av antal databitar

7 bitar	●	●	●		●			
8 bitar				●		●	●	●
Ingen paritet	●	●		●		●		
Paritet			●		●		●	●
1 stoppbit	●		●	●			●	
2 stoppbitar		●			●	●		●
Antal bitar	9	10	10	10	11	11	11	12

# Anslutningar MD-45 AC

## Linjeanslutning

(5-polig skruvplint)

Riktning	Anslutnings nr.	ITU-T V.11 Benämning
Mottagare	1	A' (R+)
Mottagare	2	B' (R-)
Sändare	3	A (T+)
Sändare	4	B (T-)
	5	Skärm

Definitionen R+/R-, T+/T- kan variera mellan olika tillverkare.

## Terminalanslutning (DCE)

(RS-232-C/V.24, 9-polig D-sub, hylsdon)

Riktning	Stift nr.	Skruvplint nr.	ITU-T V.24 Benämning	Beskrivning
I	3	8	103	TD / Transmitted Data
O	2	7	104	RD / Received Data
I	7	6	105	RTS / Request to Send
O	8	5	106	CTS / Clear to Send
O	6	2	107	DSR / Data Set Ready
-	5	9 & 1	102	SG / Signal Ground
O	1	4	109	DCD / Data Carrier Detect

I = ingång O = utgång på MD-45

## Linjekoppling

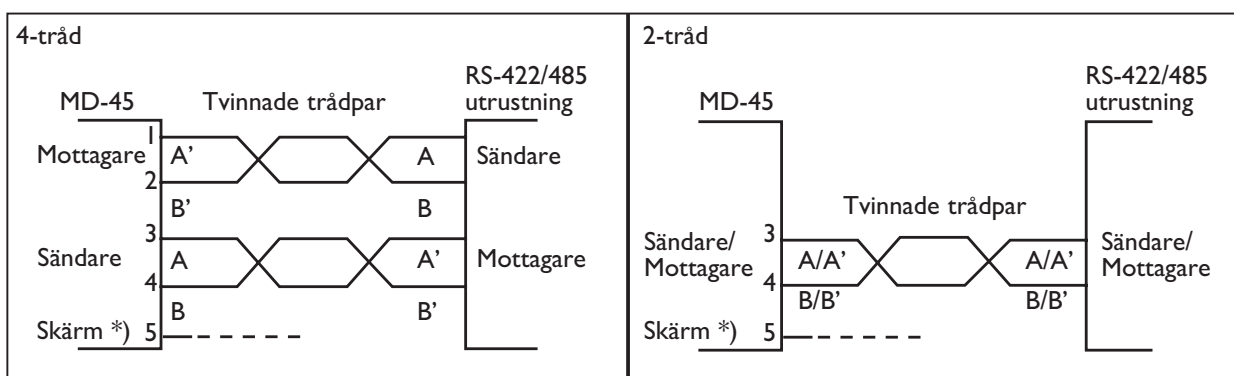

\*) Om skärmad kabel används, anslut skärmen endast i en ände för att undvika jordströmmar.

## Överföringsavstånd (gränssnitt 2)

Använd partvinnad kabel. Max ledningslängd 1200 m  
(gäller för kabel med area 0,3 mm<sup>2</sup> och kapacitans 42pF/m)  
Överföringsegenskaperna förbättras med sänkt kapacitans och ökad kabelarea.  
I störningsrik miljö bör skärmad kabel användas.

### MD-45 LV

#### Specifikationer

**Inspänningsområde** 12–45 V AC, 12–60 V DC

**Effektförbrukning** 2 W

**Isolationsspänning** Strömförsörjning 3 000 V,  
linjegränssnitt 1 500 V

**Säkring, FI** 1 A T 5x20 mm Wickmann

I övrigt gäller MD-45 AC specifikationerna

#### Inställningar

Enligt MD-45 AC

#### Anslutning

Enligt MD-45 AC  
förutom matning

Ansl. nr.	Spänningsanslutning
1	– Spänning
2	+ Spänning

## Tips

RS-422/485 är gränssnitt konstruerade för multidroppapplikationer. Då man kopplar upp en RS-422 alt. RS-485 förbindelse skall man tänka på att installera ett bussnät, d v s det får inte vara förgreningar på kablaget. För att få rätt kabelavslutning skall masteromvandlaren samt den sist anslutna enhetens mottagare termineras.

Nedan visas multidroppinstallation med terminering i RS-485 (2-tråds) och RS-422 (4-tråds) kommunikation.

Linjesändaren på MD-45 är endast aktiv då data mottages på RS-232 sidan.

Om det uppkommer något problem vid inkoppling av MD-45 kan lysdiodsindikeringarna vara till värdefull hjälp vid felsökning.

- PWR: Indikerar att enheten är spänningssatt.
- RD: Indikerar mottagen data på linjesidan.
- CTS: Indikerar samma som RTS.
- RTS: Indikerar RTS signalen från inkopplad utrustning.
- TD: Indikerar mottagen data på RS-232 sidan.

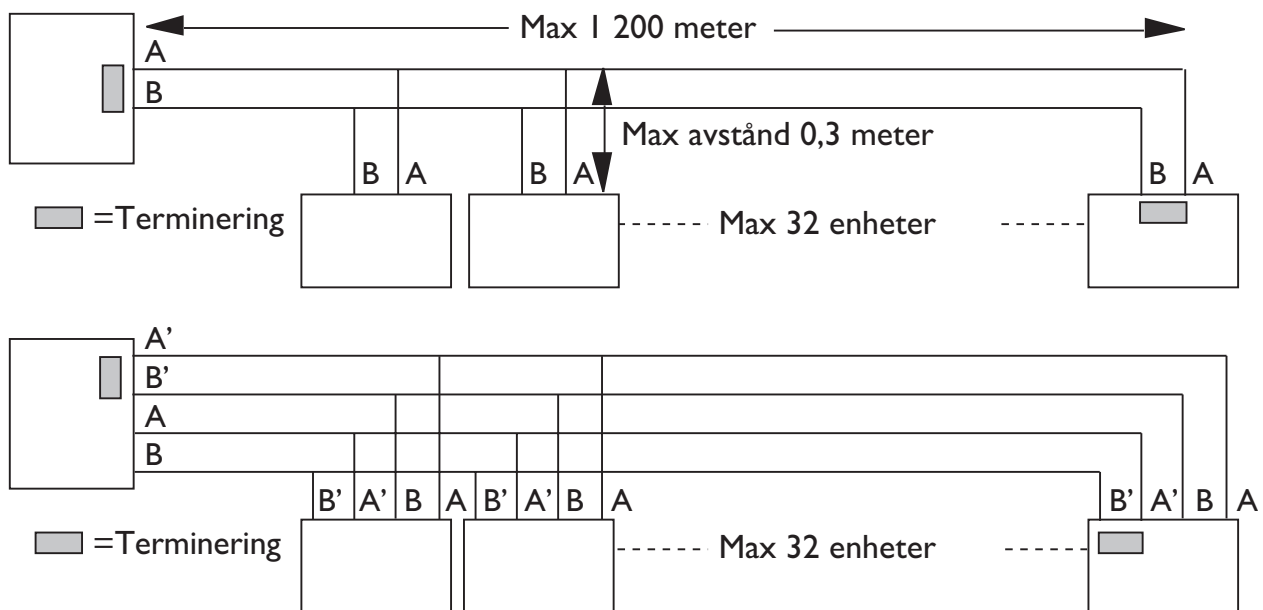

**OBS!** R+/R-, T+/T- definitionerna är ej standardiserade, det kan hjälpa att skifta A och B om ej enheten fungerar.



## Specifications MD-45

<b>Transmission</b>	Asynchronous, full/half duplex or simplex
<b>Interface 1</b>	EIA RS-232-C/ITU-T V.24 9-position D-sub female, or 9-position screw block
<b>Interface 2</b>	EIA RS-422/RS-485/ITU-T V.11, 5-position screw block
<b>Data rate</b>	1 200 bit/s – 115.2 kbit/s
<b>Indicators</b>	Power, RD, CTS, RTS, TD
<b>Isolation</b>	Galvanic isolation with opto-coupler (data transmission) and transformer (supply)
<b>Temperature range</b>	5–50°C, ambient temperature
<b>Humidity</b>	0–95% RH, non-condensing
<b>Dimensions</b>	55x100x128 mm (WxHxD)
<b>Weight</b>	0.5 kg AC / 0.25 kg LV
<b>Mounting</b>	On DIN-rail 35 mm
<b>Power supply alternatives</b>	

Model description	MD-45 AC	MD-45 115 V AC	MD-45 LV
Power supply	230 V AC +15/–10%	115 V AC +15/–10%	12–45 V AC +15/–10%
Frequency	48–62 Hz	48–62 Hz	12–60 V DC
Fuse, FI	100 mA F 5x20 mm Littlefuse	100 mA F 5x20 mm Littlefuse	1 A S 5x20 mm Wickmann
Power consumption	44 mA	22 mA	2 W
Transient protection Power/Line	Yes/Yes	Yes/Yes	–/Yes
Isolation RMS Power supply Data interface	3 000 V 1 500 V	3 000 V 1 500 V	3 000 V 1 500 V







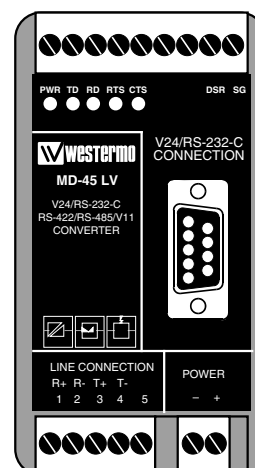
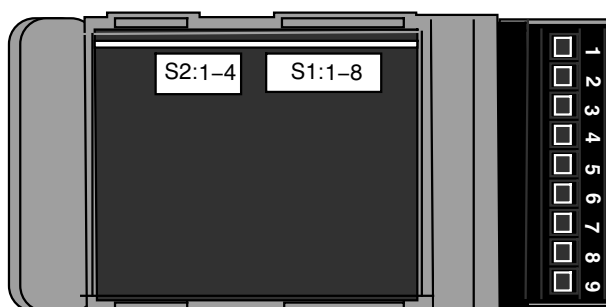

## Switch settings MD-45

The MD-45 can through different switch settings be adapted to a variety of operating conditions. To set the switches, open the plastic case by removing the top cover.



### Danger! Do not open connected unit





## Selection of data rate

	Data rate	Turning time
SI 	1 200	780 $\mu$ s
SI 	2 400	410 $\mu$ s
SI 	4 800	220 $\mu$ s
SI 	9 600	130 $\mu$ s
SI 	19 200	48 $\mu$ s
SI 	38 400	34 $\mu$ s
SI 	57 600	22 $\mu$ s
SI 	115 200	11 $\mu$ s

## Data or RTS-control





SI 	Data control
SI 	RTS-control

## Factory settings

SI 
S2 

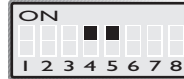
SI: 8 not used



## Selection of bits

SI 	9
SI 	10
SI 	11
SI 	12

## 2/4-wire transmission

SI 	2-wire
SI 	4-wire

## Termination with fail-safe \*

S2 	Terminated (4-wire)
S2 	Terminated (2-wire)
S2 	No termination

\* The fail-safe function forces the signal state of the receiver to OFF when the connected transmitter is in tri-state (transmitter inactive). The receiver located furthest away shall be terminated.

Supervision table when selecting data bits

7 bits	●	●	●		●		
8 bits				●		●	●
No parity	●	●		●		●	
Parity			●		●		●
1 stop bit	●		●	●		●	
2 stop bits		●			●	●	●
Number of bits	9	10	10	10	11	11	12

# Connections MD-45 AC

## Line connection

(5-position screw-terminal)

Direction	Pin no.	ITU-T V.11 Description
Receiver	1	A' (R+)
Receiver	2	B' (R-)
Transmitter	3	A (T+)
Transmitter	4	B (T-)
	5	Shield

The definitions R+/R-,T+/T- can be various between different manufactures.

## Terminal connection (DCE)

(RS-232-C/V.24, 9-position D-sub, female)

Direction	Pin no.	Screw-terminal	ITU-T V.24 Circuit number	Description
I	3	8	103	TD / Transmitted Data
O	2	7	104	RD / Received Data
I	7	6	105	RTS / Request to Send
O	8	5	106	CTS / Clear to Send
O	6	2	107	DSR / Data Set Ready
-	5	9 & 1	102	SG / Signal Ground
O	1	4	109	DCD / Data Carrier Detect

I = input    O = output on MD-45

## Line connection

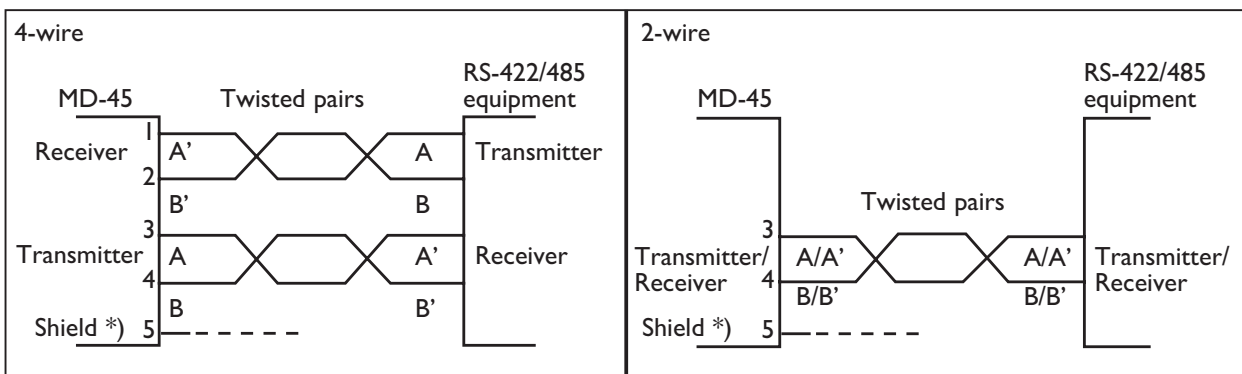

\*) If shielded cable is used, connect the shield only at one end to avoid ground currents.

## Transmission range (interface 2)

Use twisted pair cable. Max transmission range 1200 m (cable specifications 0.3 mm<sup>2</sup> and capacitance 42pF/m).

The transmission range will increase if a cable with lower capacitance and larger diameter is used.

Use shielded cable in heavy industrial environments.

## MD-45 LV

### Specifications

**Power supply** 12–45 V AC, 12–60 V DC

**Power consumption** 2 W

**Isolation** Power supply 3 000 V,  
Data interface 1 500 V

**Fuse, FI** 1 A T 5x20 mm Wickmann

! övrigt gäller MD-45 AC specifikationerna

### Switch settings

According to MD-45 AC

### Connections

According to MD-45 AC, except power supply

Connection no.	Power Supply
1	– Voltage
2	+ Voltage

# Hints

RS-422/485 was designed for multidrop applications. When a system is installed it should form a bus structure (see diagrams). Star shaped networks should never be created, there are other Westermo products designed to work in star net applications. To get a correct installation according to the RS-422/485 specification it's very important that the line is terminated at the correct points. The recommendation is to terminate the receiver on the master unit and the final bus slave unit. See diagrams for details of how this is done with RS-485 (2-wire) and RS-422 (4-wire).

The line transmitter used in the MD-45 is activated by data received on the RS-232 interface, unlike conventional converters that rely on a control signal (e.g. RTS).

If any problems do occur on set up of the MD-45, the LED's will be helpful.

- PWR: The unit has power.
- RD: Data received on the RS-422/485 interface.
- CTS: Follows RTS.
- RTS: Status of RTS from the RS-232 interface.
- TD: Data received on RS-232 interface.

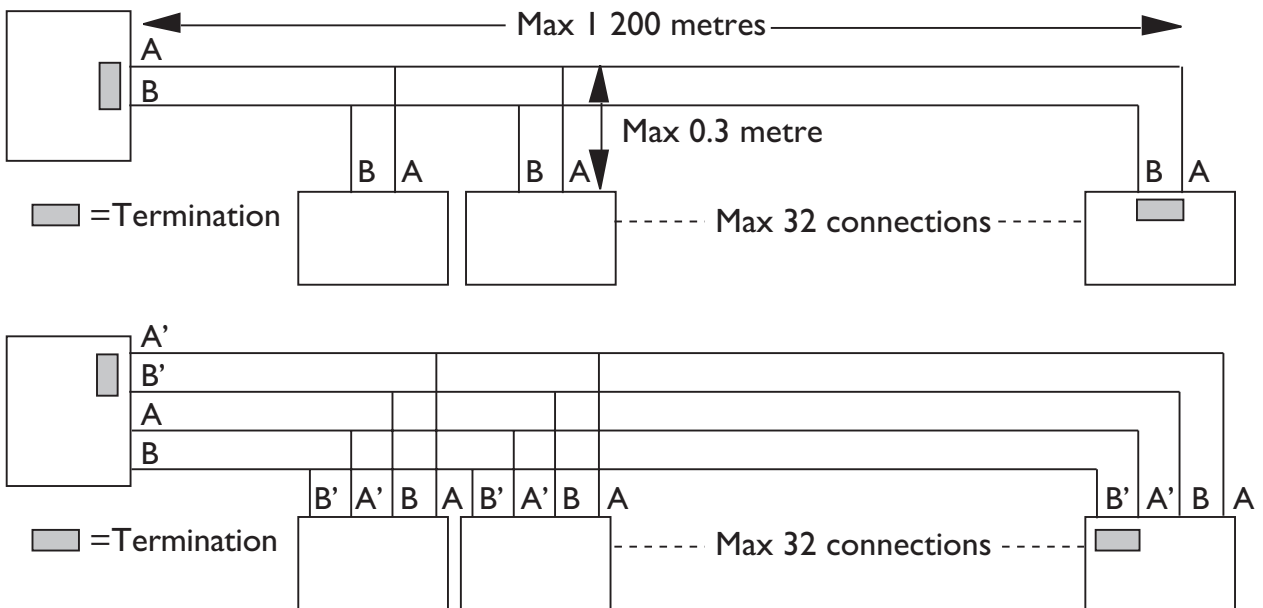

**N.B.** R+/R-, T+/T- definitions are not standard, it can help to shift A and B if the unit does not work.



## Technische Daten MD-45

<b>Übertragungsarten</b>	Asynchron, Voll-/Halbduplex oder Simplex
<b>Schnittstelle 1</b>	EIA RS-232-C/ITU-T V.24 9 polige Sub-D-Buchse, Schraubklemme
<b>Schnittstelle 2</b>	EIA RS-422/RS-485/ITU-T V.11, 5-polige Schraubklemme
<b>Übertragungsraten</b>	1 200 Bit/s bis 115,2 Kbit/s
<b>Leuchtdioden</b>	Power, RD, CTS, RTS, TD
<b>Isolation</b>	Galvanisch Isoliert mittels Optokoppler (Datenübertragung) und Transformator (Spannungsversorgung)
<b>Umgebungstemperatur</b>	5–50°C
<b>Luftfeuchtigkeit</b>	0–95%, nicht kondensierend
<b>Abmessungen</b>	55x100x128 mm (BxHxT)
<b>Gewicht</b>	0,5 kg AC / 0,25 kg DC
<b>Installation</b>	auf 35 mm Din-Schiene
<b>Spannungsversorgung Alternativen</b>	

Modellbezeichnung	MD-45 AC	MD-45 115 V AC	MD-45 LV
Stromversorgung	230 V AC +15/–10%	115 V AC +15/–10%	12–45 V AC +15/–10%
Frequenz	48–62 Hz	48–62 Hz	12–60 V DC
Sicherung FI	100 mA 5x20 mm Littelfuse	100 mA 5x20 mm Littelfuse	1 A 5x20 mm Wickmann
Leistungsaufnahme	22 mA	44 mA	2 W
Transientenschutz Stromvers./Schnittst.	Ja/Ja	Ja/Ja	–/Ja
Isolation RMS Stromversorgung Schnittstelle	3 000 V 1 500 V	3 000 V 1 500 V	3 000 V 1 500 V







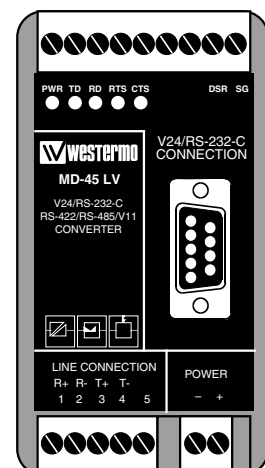
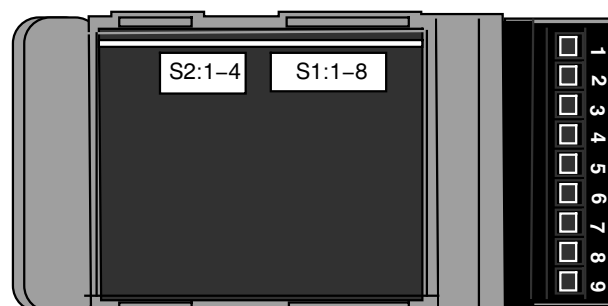

## DIP-Schalter Einstellung MD-45

Das MD-45 bietet verschiedene Einstellmöglichkeiten zur Abstimmung auf verschiedenste Betriebsverhältnisse. Um die DIP-Schalter einzustellen muß die Gehäuseabdeckung z.B. mit Hilfe eines Schraubendrehers abgenommen werden.

### Achtung! Angeschlossene Geräte nicht öffnen



## Übertragungsgeschwindigkeit

	Übertragungsrate	Umschaltzeit
SI 	1 200	780 µs
SI 	2 400	410 µs
SI 	4 800	220 µs
SI 	9 600	130 µs
SI 	19 200	48 µs
SI 	38 400	34 µs
SI 	57 600	22 µs
SI 	115 200	11 µs

## Data oder RTS-Kontrol

SI  Datenfluß

SI  RTS-Steuerung

## Werkseinstellungen

SI 

S2 

SI: 8 nicht benutzt

## Anzahl der Datenbits

SI  9

SI  10

SI  11

SI  12

## 2/4-Draht Übertragung

SI  2-Draht

SI  4-Draht

## Termination mit fail-safe \*

S2  4-Draht Termination

S2  2-Draht Termination

S2  Keine Termination

\* Die fail-safe Funktion zwingt den Empfänger in AUS-Zustand zu gehen, wenn der angeschlossene Sender im Tri-State Zustand ist (Sender nicht aktiv). Der am weitesten entfernte Empfänger sollte terminiert werden.

Übersichtstabelle für Datenlänge

7 Bits	●	●	●		●		
8 Bits				●		●	●
Keine Parität	●	●		●		●	
Parität			●		●		●
1 Stop Bit	●		●	●		●	
2 Stop Bit		●			●	●	●
Anzahl der Bits	9	10	10	10	11	11	12

# MD-45 AC

## Leitungsanschluß

(5-polige Schraubklemme)

Richtung	Anschluß Nr.	ITU-T V.11 Beschreibung
Empfänger	1	A' (R+)
Empfänger	2	B' (R-)
Sender	3	A (T+)
Sender	4	B (T-)
	5	Schirmung

Die Bezeichnungen R+/R-, T+/T- können abhängig vom Hersteller variieren.

## Terminalanschluß (DÜE)

(RS-232-c/V.24, 9-polige Sub-D Buchse)

Richtung	Pin Nr.	Klemme	ITU-T V.24 Bezeichnung	Beschreibung
I	3	8	103	TD / Transmitted Data
O	2	7	104	RD / Received Data
I	7	6	105	RTS / Request to Send
O	8	5	106	CTS / Clear to Send
O	6	2	107	DSR / Data Set Ready
-	5	9 & 1	102	SG / Signal Ground
O	1	4	109	DCD / Data Carrier Detect

I = Eingang    O = Ausgang des MD-45

## Leitungsanschluß

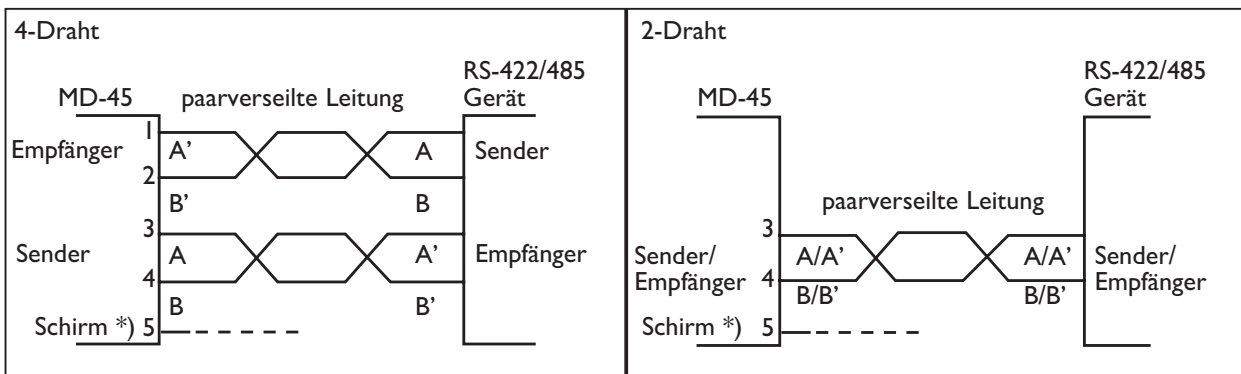

\*) Bei Verwendung von abgeschirmten Kabeln den Schirm nur auf einer Seite anschließen um Erdströme zu vermeiden

## Übertragungsweiten (Schnittstelle2)

Benutzen Sie paarverseilte Leitungen. Maximale Übertragungsweite 1 200 m. (bei Kabelspezifikationen von 0,3 mm<sup>2</sup> und 42 pF/m). Die Übertragungsweite nimmt bei kleinerer Kapazität und größerem Durchmesser zu. Benutzen Sie abgeschirmte Kabel in schlechter Umgebung.

### MD-45 DC

#### Technische Daten

**Spannungsversorgung** 12–45 V AC, 12–60 V DC  
**Leistungsaufnahme** 2 W  
**Isolationsspannung** Spannungsversorgung 3 000 V  
Datenschnittstelle 1500 V  
**Sicherung, FI** 1 A T 5x20 mm Wickmann

Alle anderen Merkmale siehe MD-45 AC

#### DIP-Schalter Einstellungen

Siehe MD-45 AC

#### Anschlüsse

Siehe MD-45 AC, außer Spannungsversorgung

Anschluß Nr.	Spannungsversorgung
1	– Pol
2	+ Pol

## Tips

Der Schnittstellenstandard RS-422/485 wurde für Mehrpunktverbindungen entwickelt. Dieser Standard ist für Busnetze (siehe Beispiele) geeignet. Sternnetze sollten vermieden werden. Für eine korrekte Installation eines RS-422/485 sollte an den richtigen Punkten die Termination eingeschaltet werden. Es sollte am Empfänger des Masters und am letzten Slave die Termination eingeschaltet werden. Siehe Beispiele für RS-485 (2-Draht) und RS-422 (4-Draht) Termination.

Der Sender des MD-45 wird aktiviert sobald Daten an der RS-232 Schnittstelle empfangen werden, nicht wie normale Konverter die ein Kontrollsignal z.B. RTS benötigen.

Bei Problemen mit der Einstellung des MD-42 können die LED's hilfreich sein:

- PWR Das Gerät hat Versorgungsspannung
- RD Daten Empfang an der RS-422/485 Schnittstelle
- CTS folgt RTS.
- RTS zeigt den Status der RS-232 Schnittstelle an.
- TD Daten Empfang an der RS-232 Schnittstelle

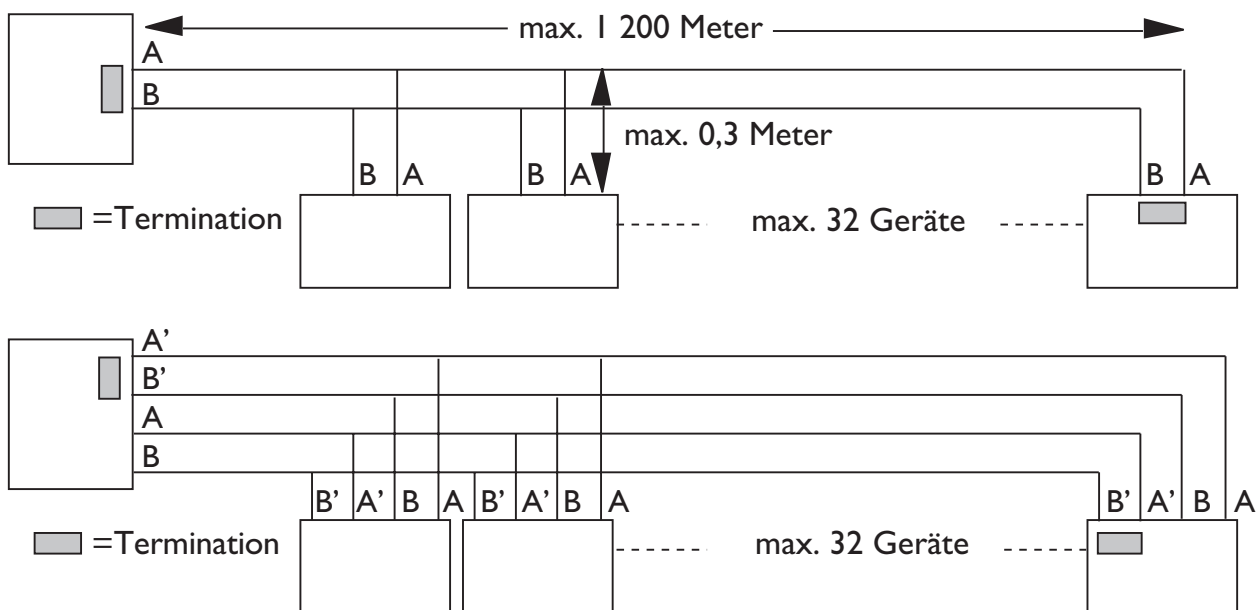

**Hinweis:** Die Bezeichnungen R+/R-, T+/T- sind nicht Standard, es kann bei Problemen helfen, A und B zu tauschen.



## Spécifications MD-45

<b>Transmission</b>	Asynchrone, full/half duplex ou simplex
<b>Interface 1</b>	EIA RS-232-C/ITU-T V.24 Connecteur sub-D 9 points femelle, DCE ou Bornier à vis 9 points.
<b>Interface 2</b>	EIA RS-422/RS-485/ITU-T V.11 Bornier à vis 5 points.
<b>Vitesse</b>	1 200 bit/sec – 115,2 kbit/s
<b>Indicateurs LED</b>	Power, RD, CTS, RTS, TD
<b>Isolation</b>	Isolation galvanique avec opto-coupleur (transmission de données) et transformateur (alimentation)
<b>Gamme température</b>	5–50°C température ambiante
<b>Humidité</b>	0–95% RH non condensé
<b>Dimensions</b>	55x100x128 mm (LxHxP)
<b>Poids</b>	0,5 kg AC, / 0,25 kg LV
<b>Fixation</b>	Sur Rail DIN 35 mm

### Possibilités d'alimentation

Référence Modèle	MD-45 AC	MD-45 115 V AC	MD-45 LV
Tension d'alimentation	230 V AC +15/-10%	115 V AC +15/-10%	12-45 V AC +15/-10%
Fréquence	48-62 Hz	48-62 Hz	12-60 V DC
Fusible, FI	100 mA F 5x20 mm Littelfuse	100 mA F 5x20 mm Littelfuse	1 A S 5x20 mm Wickmann
Consommation	44 mA	22 mA	2 W
Protection Surtension Alimentation/Ligne	Oui/Oui	Oui/Oui	-/Oui
Isolation RMS : Alimentation Interface Donnée	3 000 V 1 500 V	3 000 V 1 500 V	3 000 V 1 500 V



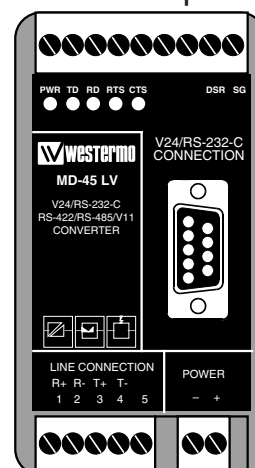
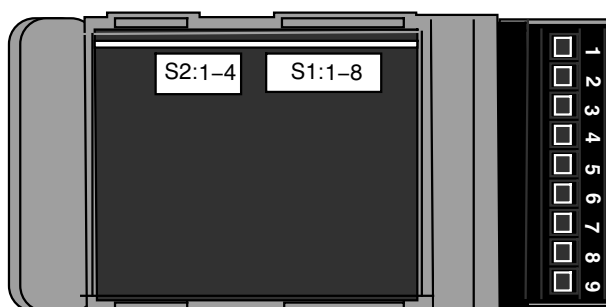

## Configuration des micro-interrupteurs du MD-45

Le MD-45 peut être adapté à différents environnements à l'aide de la configuration des micro-interrupteurs. On accède aux micro-interrupteurs en enlevant le capot supérieur.

### ATTENTION ! Ne pas ouvrir sous tension

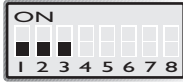

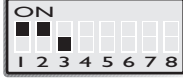
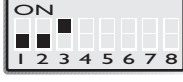
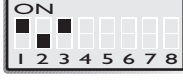
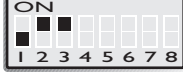

## Configuration du débit des données

	Débit des données	Temps de retournement
SI 	1 200	780 µs
SI 	2 400	410 µs
SI 	4 800	220 µs
SI 	9 600	130 µs
SI 	19 200	48 µs
SI 	38 400	34 s
SI 	57 600	22 µs
SI 	115 200	11 µs

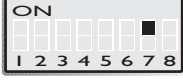
## Contrôle Retournement





SI 	Flux de Données
SI 	Contrôle RTS

## Configuration Usine

SI 
S2 

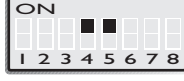
SI : 8 non utilisés



## Sélection du nombre de bits

SI 	9
SI 	10
SI 	11
SI 	12

## Transmission 2/4 Fils

SI 	2 fils
SI 	4 fils

## Terminaison avec niveau de sécurité\*

S2 	Terminé (4 fils)
S2 	Terminé (2 fils)
S2 	No termination

\* La fonction niveau de sécurité force l'état du signal récepteur sur OFF quand l'émetteur connecté est en mode 3 états, (émetteur inactif). Le récepteur le plus éloigné doit être équipé d'une terminaison.

Table de contrôle pour sélection du nombre de bits

7 Bits	●	●	●		●		
8 Bits				●		●	●
Pas de parité	●	●		●		●	
Parité			●		●		●
1 bit de stop	●		●	●		●	
2 bits de stop		●			●	●	●
Nombre de bits	9	10	10	10	11	11	12

# Connexions MD-45 AC

## Connexion Ligne

(Bornier à vis 5 points)

Direction	N°	ITU-T V.11 Description
Récepteur	1	A' (R+)
Récepteur	2	B' (R-)
Emetteur	3	A (T+)
Emetteur	4	B (T-)
	5	Blindage

Les définitions R+/R-, T+/T- peuvent changer suivant les constructeurs.

## Connexion Terminal (DCE)

(RS-232-C/V.24, Connecteur sub-D 9 points femelle / bornier à vis)

Direction	point N°	Bornier à vis	ITU-T V.24 Circuit N°	Description
I	3	8	103	TD/Donnée transmise
O	2	7	104	RD/Donnée reçue
I	7	6	105	RTS/Request To Send
O	8	5	106	CTS/Clear To Send
O	6	2	107	DSR/Data Set Ready
-	5	9 & 1	102	SG/ Masse
O	1	4	109	DCD/Data Carrier Detect

I = Input (entrée)    O = Output (sortie) sur le MD-45

## Connexion Ligne

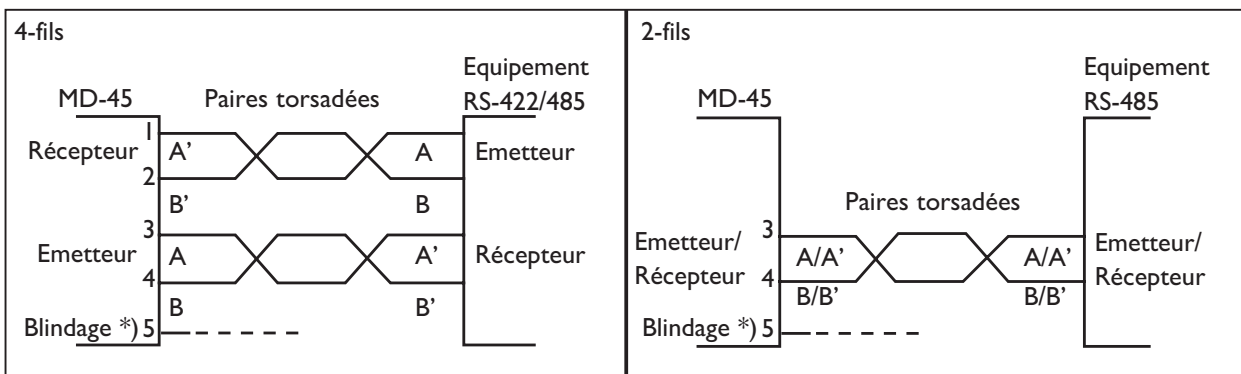

\*) Si on utilise un câble blindé, connecter le blindage uniquement à une extrémité afin d'éviter les retours de courant de terre.

## Distance de transmission (interface 2)

La distance de transmission maximale est de 1200 m avec un câble en paire torsadée. (Spécifications câble 0.3 mm<sup>2</sup> et capacité de 42pF/m).

La distance de transmission augmentera si on utilise un câble ayant une section plus importante et une capacité plus faible.

Utiliser un câble blindé dans des environnements industriels intenses.

## MD-45 LV

### Caractéristiques

**Alimentation** 12–45 V AC, 12–60 V DC

**Consommation** 2 W

**Isolation** Alimentation : 3 000 V  
Interface Données : 1 500 V

**Fusible FI** 1 A T 5x20 mm Wickmann

Toutes les autres caractéristiques sont identiques à celles du MD-45 AC

### Configuration des micro-interrupteurs

Identique à celle du MD-45 AC

### Connexions

Identiques à celles du MD-45 AC excepté l'alimentation

Connexion N°	Alimentation
1	Tension –
2	Tension +

## Conseils Pratiques

Le MD-45 utilise une interface RS-422/485. Le standard RS422/485 a été conçu pour des applications multipoints.

Le réseau est installé sous la forme d'une structure bus (voir diagramme).

Les réseaux en forme d'étoile sont proscrits.

Il existe d'autres produits Westermo qui permettent de travailler avec un réseau en étoile.

Une installation correcte d'un réseau RS-422/485 doit toujours être équipée d'une terminaison sur les points correspondants.

Il est indispensable d'équiper de terminaisons le récepteur de l'unité maître ainsi que le dernier esclave qui termine le bus.

Le diagramme ci-contre vous montre comment est réalisée une connexion RS-485 (2 fils) et RS-422 (4 fils)

La fonction émission utilisée dans le MD-45 peut être activée soit par détection du flux de données reçu sur le port RS-232, soit par le contrôle RTS en modifiant le micro interrupteur correspondant (voir page 3 contrôle retournement).

Si un problème survient pendant la configuration du MD-45, les LED de statut peuvent vous aider.

- PWR: L'unité est alimentée.
- RD: Réception de données sur l'interface RS-422/485.
- CTS: Suit le signal RTS.
- RTS: Statut du signal RTS provenant de l'interface RS-232.
- TD: Réception de données sur l'interface RS-232/V.24

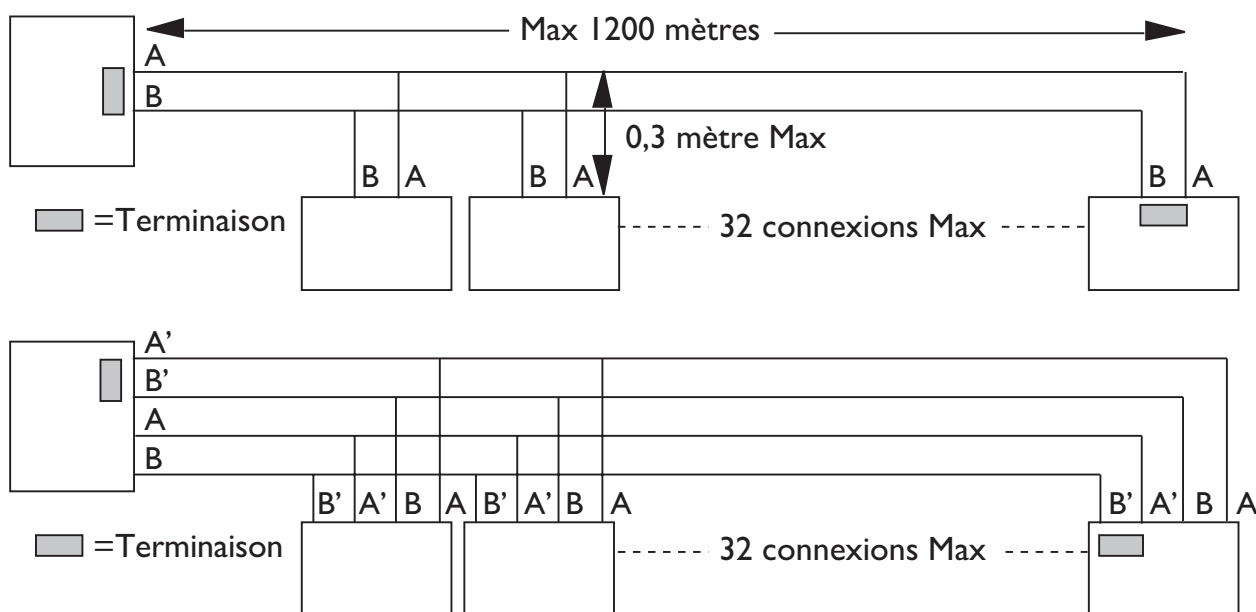

**Nota :** Les définitions R+/R-,T+/T- ne sont pas standard. On peut résoudre dans certains cas des problèmes de connexion en inversant les fils A et B si les équipements ne fonctionnent pas.



# Block diagram

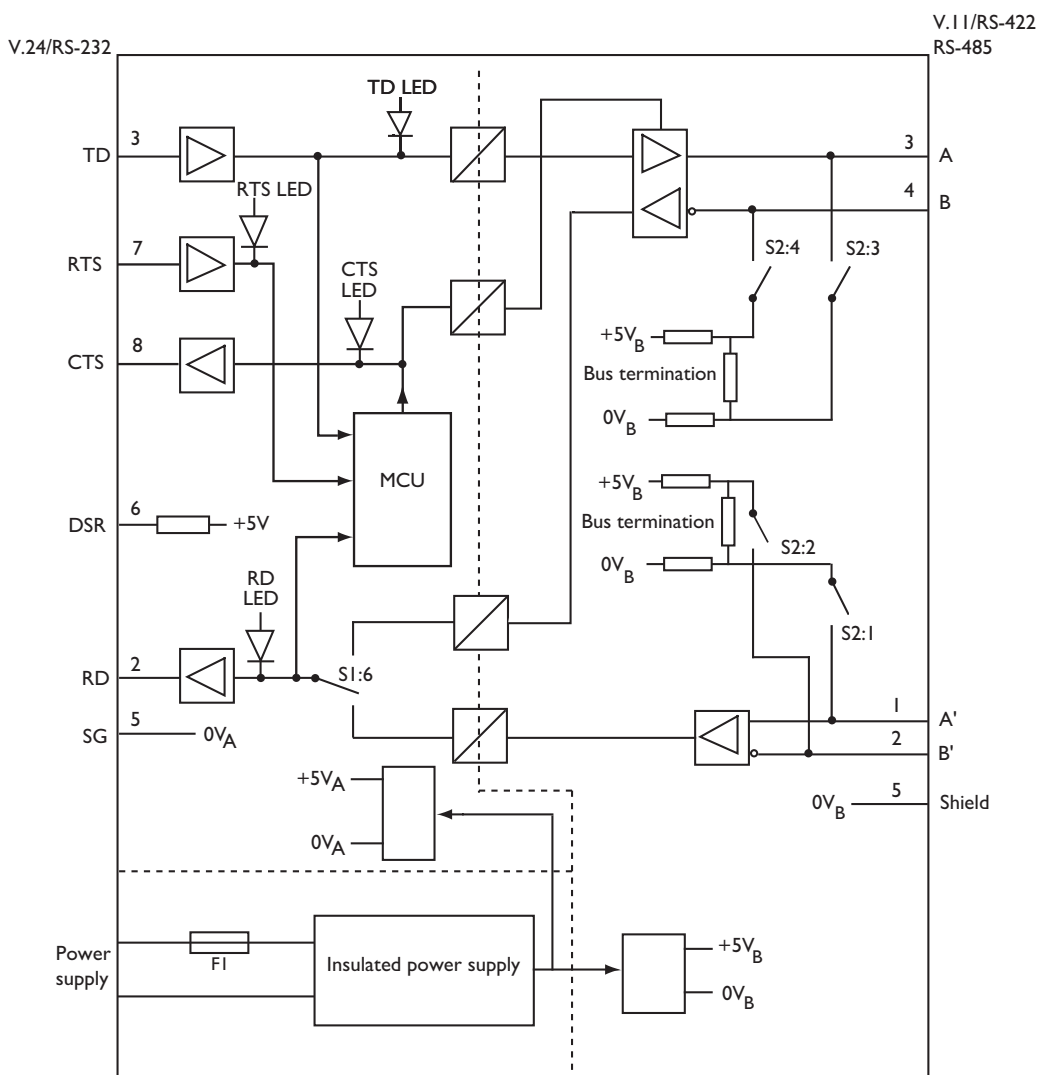

Westermo Teleindustri AB • SE-640 40 Stora Sundby, Sweden  
 Phone +46 16 42 80 00 Fax +46 16 42 80 01  
 E-mail: [info@westermo.se](mailto:info@westermo.se) • Westermo Web site: [www.westermo.se](http://www.westermo.se)

## Subsidiaries

Westermo Data Communications Ltd  
 Unit 14 Talisman Business Centre • Duncan Road  
 Park Gate, Southampton • SO31 7GA  
 Phone: +44(0)1489 580 585 • Fax: +44(0)1489 580586  
 E-Mail: [sales@westermo.co.uk](mailto:sales@westermo.co.uk) • Web: [www.westermo.co.uk](http://www.westermo.co.uk)

Westermo Data Communications GmbH  
 Goethestraße 67, 68753 Waghäusel  
 Tel.: +49(0)7254-95400-0 • Fax: +49(0)7254-95400-9  
 E-Mail: [info@westermo.de](mailto:info@westermo.de) • Web: [www.westermo.de](http://www.westermo.de)

Westermo Data Communications S.A.R.L.  
 9 Chemin de Chilly 91160 CHAMPLAN  
 Tél : +33 1 69 10 21 00 • Fax : +33 1 69 10 21 01  
 E-mail : [infos@westermo.fr](mailto:infos@westermo.fr) • Site WEB: [www.westermo.fr](http://www.westermo.fr)

Westermo Teleindustri AB have distributors in several countries, contact us for further information.