



PROCESS CONTROL UNITS ESM-XX50



ESM-4450, ESM-7750, ESM-9950, ESM-4950, ESM-9450
Universal Input PID Process Controller with
Smart I/O Module System

- 4 digits process (PV) ve 4 digits process set (SV) display
- Universal process input(TC, RTD, mV, V, mA)
- Optional secondary sensor input
- Dual or multi point calibration for voltage & current input
- Configurable ON/OFF, P, PI, PD and PID control forms
- Auto-tune and Self-tune PID
- Manual/Automatic mode selection for control outputs
- Bumpless transfer
- Motorized valve control function
- Programmable heating, cooling and alarm functions for control outputs
- 8 steps profile control (Ramp & Soak) function and start-holdstop by using logic input module
- Remote set point function by using analogue input modules
- Re-Transmission
- Detection of heater failure by using 0...5 A~CT input module
- Smart I/O module system
- RS-232 (standard) or RS-485 (optional) serial communication with Modbus RTU protocol

SPECIFICATIONS:

Process Inputs

Universal Input: Universal input, TC, RTD, Voltage/Current Thermocouple (TC) : L(DIN 43710) , J , K , R , S , T , B , E ve N (IEC584.1)(ITS90) , C (ITS90)
Thermoresistance (RTD) : PT-100 (IEC751)(ITS90)

Input : mV, V, mA

Measurement Range: Please refer to Table-1 for selection of input type and scale.

Accuracy: ± 0.25% of full scale for thermocouple, thermoresistance and voltage

Cold Junction Compensation: Automatically ± 0.1°C/1°C.

Line Compensation: Maximum 10 Ohm

Sensor Break Protection: Upscale

Sampling Cycle: 3 samples per second

Input Filter : 0.0 ile 900.0 seconds

CONTROL

Control Forms: Programmable ON / OFF, P, PI, PD or PID.

OUTPUT

Standard Relay Output : 5A@250V~ (Programmable control or alarm output) (Electrical Life : 100.000 Operation (Full Load))

Output Modules

-Relay Output Module

-SSR Driver Output Module (Max.20mA@18V~)

-Digital (Transistor) Output Module (Maks.40 mA@18V~)

-0/4...20 mA~ Current Output Module

Input Modules

-Digital Input Module

-0/4...20 mA~ Current Input Module

-0...5A~ CT Input Module

-TC or 0...50mV~ Input Module

-PT-100 Input Module

-0...10V~ Input Module

Supply Voltage

100-240V ~ 50/60 Hz (-%15;+%10) -6VA

24V ~ 50/60 Hz(-%15 ; +%10)-6VA or 24V ~ (-%15 ; +%10)-6W

(Supply Voltage must be determined in order.)

INDICATORS

Process Indicators :

ESM-4450 and ESM-9450 : 10.1 mm Red 4 digit LED Display
ESM-4950 and ESM-7750 : 13.2 mm Red 4 digit LED Display
ESM-9950 : 19 mm Red 4 digit LED Display

Setpoint Indicators :

ESM-4450, ESM-4950 and ESM-9450 : 8 mm Green 4 digit LED Display
ESM-7750 : 9.1 mm Green 4 digit LED Display
ESM-9950 : 10.8 mm Green 4 digit LED Display

LED Indicators : AT(Auto Tuning), SV(Set Value), Man(Manual Operation)Auto(Auto Operation), O1/2/3 (Output status Leds), °C, °F, V, Ramp and Remote LEDs

Environmental Ratings and Physical Specifications

Operating Temperature: 0...50°C

Max. Operating Humidity : 0-90%RH (non-condensing)

Protection Class : NEMA 4X (IP65 at front, IP20 at rear).

Weight:

ESM-4450 : 210 gr.

ESM-4950 : 260 gr.

ESM-7750 : 270 gr.

ESM-9950 : 370 gr.

ESM-9450 : 260 gr.

Dimensions:

ESM-4450 : (48 x 48mm, Depth :116 mm)

ESM-4950 : (96 x 48mm, Depth :86.5 mm)

ESM-7750 : (72 x 72mm, Depth :87.5 mm)

ESM-9950 : (96 x 96mm, Depth :87.5 mm)

ESM-9450 : (48 x 96mm, Depth :86.5 mm)

Panel Cut-Out

ESM-4450 : (46 x 46mm)

ESM-4950 : (92 x 46mm)

ESM-7750 : (69 x 69mm)

ESM-9950 : (92 x 92mm)

ESM-9450 : (46 x 92mm)

Electrical Connections

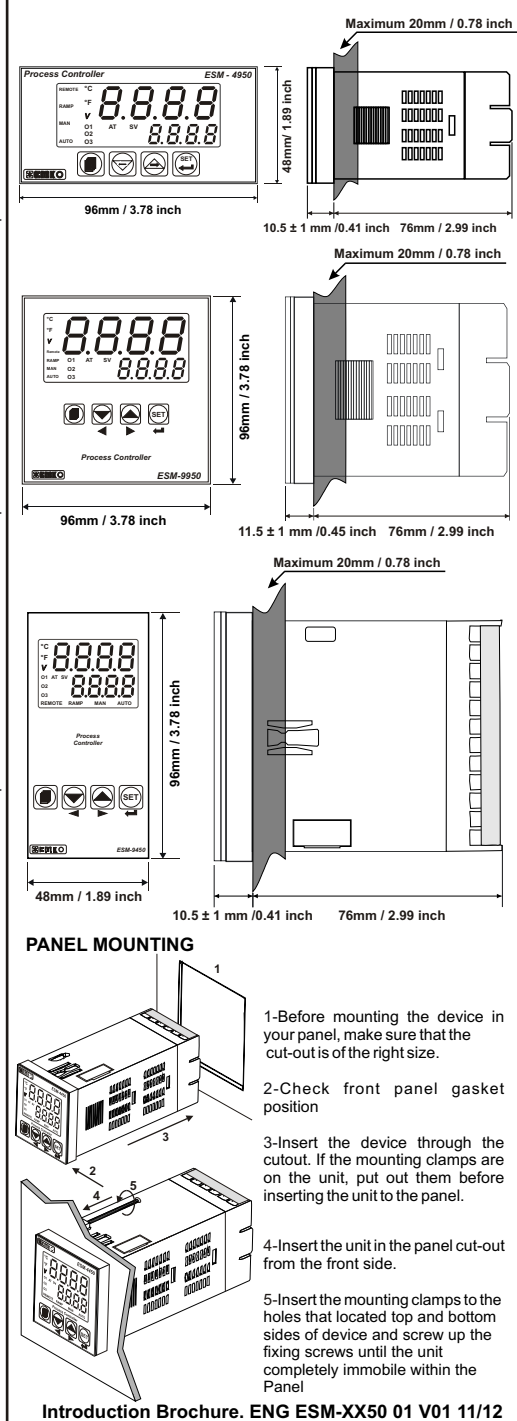
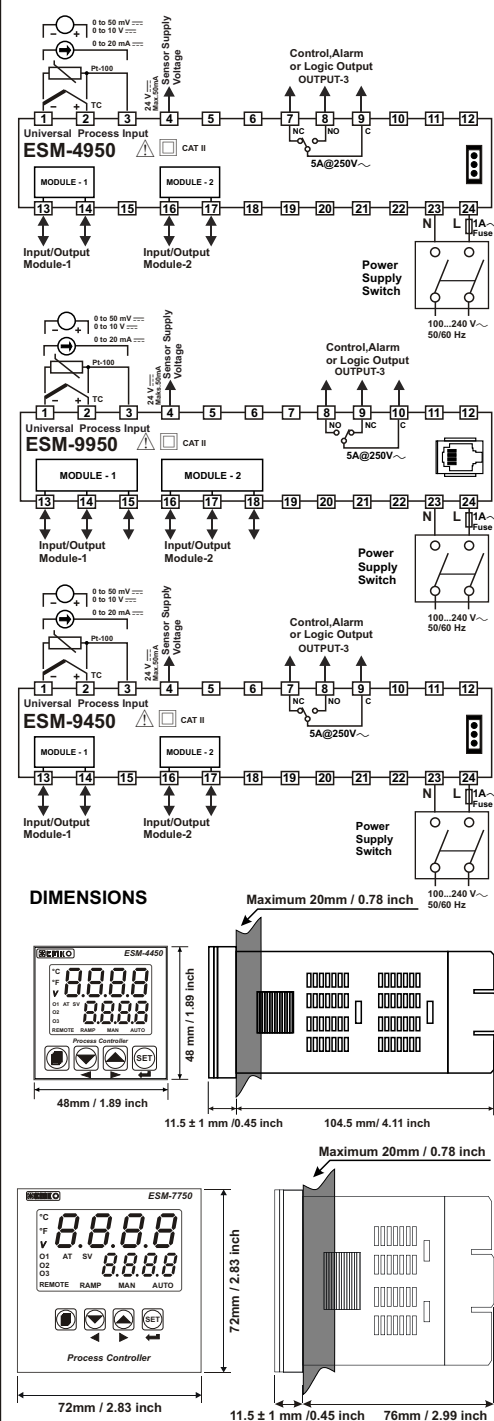
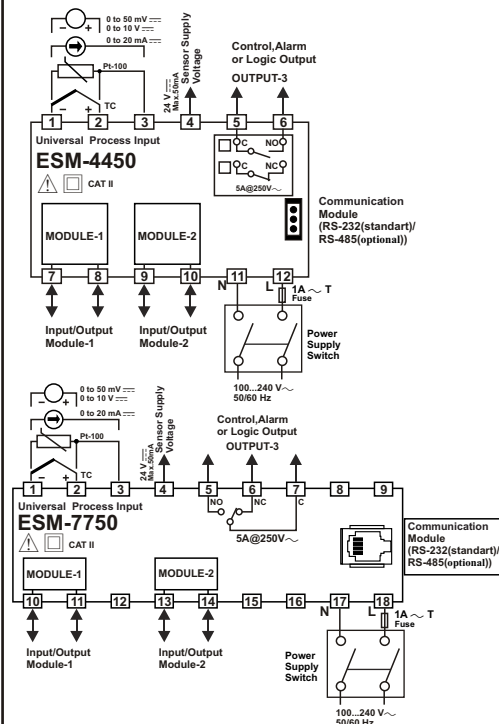

Adjustment of Process Set Value

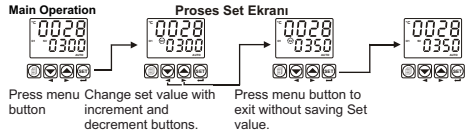

Easy Access Diagram for Operator Parameters

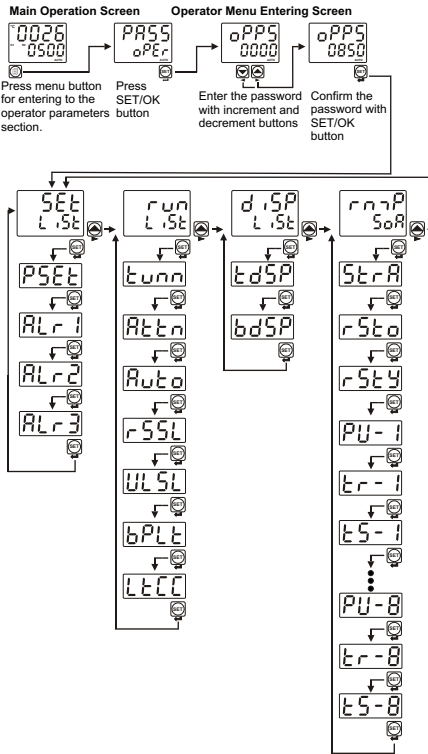

Easy Access Diagram for Technician Parameters

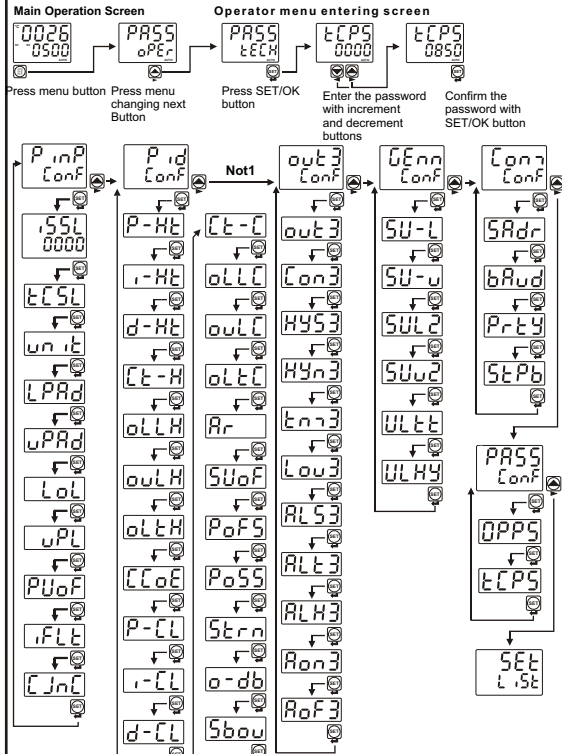

Set LiSt: Set values

- PSEt** Proses Set (-1999,9999)Unit
- ALr1** Alarm-1 Set (-1999,9999)Unit
- ALr2** Alarm-2 Set (-1999,9999)Unit
- ALr3** Alarm-3 Set (-1999,9999)Unit

Run LiSt: Selection of PID Tune and Operation Form

TUNE SELECTIONBy selecting one of the methods below, device can determine the PID parameters.

- Device operates according to the defined PID
- Auto tune (Limit Cycle Tuning) operation
- Self tune (Step Response Tuning) operation
- Auto-Self Tune Self Tune operation is performed, if the conditions are realized when power on firstly. In normal operation, it controls the tune conditions in Auto Tune selection which explained below. If any of the conditions is realized, it performs the Auto Tune operation

AUTOMATIC TUNE SELECTION

- Device does not do (Limit Cycle Tuning) operation
- Device does (Limit Cycle Tuning) operation

OPERATION FORM SELECTION

- Automatic: The device automatically calculates the %output
- Manual: %output rate can be controlled manually by using direction buttons.

Ramp/Soak Control

- Ramp/Soak function is deactivated
- Ramp/Soak function is active
- Ramp/Soak function is holding. Real time is stopped

MOTORIZED VALVE CONTROL

- Motorized valve control is deactive
- Motorized valve runs with heating PID function.
- Motorized valve runs with cooling PID function.

BUMPLESS TRANSFER

- Process output value in manual control is not taken into consideration while passing from manual control to automatic control. New control output that is measured in automatic control is applied to process output. Last %output value is taken output value of manual control and manual control continues while passing from automatic control to manual control

- While passing from manual control to automatic control, last process output value in manual control is accepted as first process output value in automatic control and automatic control continues to run. Last % process output value in automatic control is accepted as process output value of manual control and manual control continues to run.

ALARM LATCH CANCELING

- Alarm latch canceling is not performed.
- If there is an alarm output with latching and there is no alarm status, latching operation will be finished by the device. When it is finished, this parameter becomes Automatically

diSP LiSt: Function Selection for Top and Bottom Display

- t.dSP** It defines the function of the top display. This parameter determines which value is shown in top display.
 - Process value (PV) is shown in top display
 - Result of subtraction of process set value from process value (SV-PV) is shown in top display
 - If one of the analogue input modules is plugged in Module-1 or Module-2 socket, measured value from this module input is shown in top display.
- b.dSP** It defines the function of the bottom display. This parameter determines which value is shown in bottom display.
 - Process set value (SV) is shown in bottom display.
 - %Output value that is applied to process control output is shown in bottom display.
 - Status of the Ramp/Soak function is shown in bottom Display.
 - If one of the analogue input modules is plugged in Module-1 or Module-2 socket, measured value from this module input is shown in bottom display.
 - If CT~ input module (EMI-420) is plugged in Module-1 or Module-2 socket, measured value from this module input is shown in bottom display.

rmP SoA: Configuration of RAMP/SOAK Function and Step SET Values

- StrA** Soft-Start parameter
Proses değeri, cihaz enerjilendiğinde set değerine bu parametrede tanımlanan süre sonunda erişir.
- r.sto** Ramp Soak tolerans parametresi (%0;%50 Skala)Birim
Ramp/Soak işleminde, proses değerinin artı veya eksi yönde bu parametre ile tanımlanan toleransın dışına çıkması durumunda zaman durdurulur.
- r.sty** Ramp/Soak program step selection parameter.
 - 1.program 1-4 steps
 - 2.program 5-8 steps
 - Steps between 1-8 is used as one program.
- PU-1** Ramp/Soak step set value.
For ramp operation ; process value reaches to step set values that are defined with these parameters at the end of the time that are defined in ramp time parameters. For soak operation ; process value is constant in ramp time parameters. For soak operation ; process value is constant in step set value that are defined in these parameters for time that are defined in soak time parameters. Ramp/Soak step set values can be adjusted from minimum value of set scale to maximum value of set scale.
- t.r-1** Ramp time for Ramp/Soak
Process value reaches to step set values at the end of the time that are defined in these parameters.
- t.s-1** Soak time for Ramp/Soak
Process value is constant in step set value for time that are defined in these parameters.

P.inP Conf: Process Input Type and Relevant Parameters with Process Input

- t.SSt** Defines the process input
 - TC input type selection
 - RTDinput type selection
 - Voltage/Current input type selection.

t.CSt Defines type and scale of the thermocouple for TC input. It is active if TC input type is selected

- L (-100.0°C;850.0°C) or (-148.0°F;999.9°F)
- L (-100.0°C;850.0°C) or (-148.0°F;999.9°F)
- J (-200.0°C;900.0°C) or (-328°F;1652°F)
- J (-199.9°C;900.0°C) or (-199.9°F;999.9°F)
- K (-200.0°C;1300.0°C) or (-328°F;2372°F)
- K (-199.9°C;999.9°C) or (-199.9°F;999.9°F)
- R (0.0°C;1700.0°C) or (32°F;3092°F)
- R (0.0°C;999.9°C) or (32.0°F;999.9°F)
- S (0.0°C;1700.0°C) or (32°F;3092°F)
- S (0.0°C;999.9°C) or (32.0°F;999.9°F)
- T (-200.0°C;400.0°C) or (-328°F;752°F)
- T (-199.9°C;400.0°C) or (-199.9°F;752.0°F)
- B (44.0°C;1800.0°C) or (111°F;3272°F)
- B (44.0°C;999.9°C) or (111.0°F ; 999.9°F)
- E (-150.0°C;700.0°C) or (-238°F;1292°F)
- E (-150.0°C;700.0°C) or (-199.9°F;999.9°F)
- N (-200.0°C;1300.0°C) or (-328°F;2372°F)
- N (-199.9°C;999.9°C) or (-199.9°F;999.9°F)
- C (0.0°C;2300.0°C) or (32°F;3261°F)
- C (0.0°C;999.9°C) or (32.0°F;999.9°F)

r.tdS Defines type and scale of sensor for RTD input. It is active if RTD input

- PT-100 (-200.0°C ; 650.0°C) or (-328°F ; 1202°F)
- PT-100 (-199.9°C ; 650.0°C) or (-199.9°F ; 999.9°F)

VARS: Voltage / Current Input Selection

This parameter is active if ---Voltage / Current is selected.

- 0...50mV --- (-1999 ; 9999)
- 0...5V --- (-1999 ; 9999)
- 0...10V --- (-1999 ; 9999)
- 0...20mA --- (-1999 ; 9999)
- 4...20mA --- (-1999 ; 9999)

dPnt: Display Point Position

This parameter is active if ---Voltage / Current is selected.

- No point
- Between first and second digits "0.0"
- Between second and third digits "0.00"
- Between third and fourth digits "0.000"

WCR: Display Value Adjustment Type

- Fixed dual point display adjustment. Display adjustment low point value is fixed to -1999, display adjustment high point value is fixed to 9999.
- User can do dual point display adjustment with tPoL and tPoH.
- User can do defined 16 display adjustment points.

tPoL: Low Point Display adjustment (-1999, 9999)Unit

Active if ---Voltage / Current input is selected.

tPoH: High Point Display adjustment (-1999, 9999)Unit

Active if ---Voltage / Current input is selected.

Po00: Display adjustment points (-1999, 9999)Unit

This parameter is active if ---Voltage / Current is selected. In multi point display adjustment operation, defined scale is divided into 16 adjustment points.

For example : is (0-50 mV---).

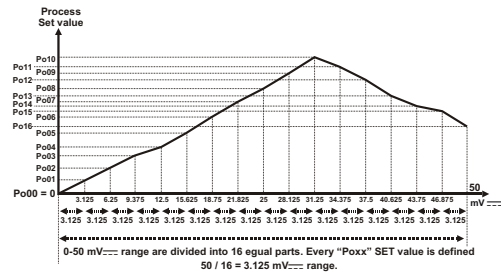

COEF Coefficient value (1.000, 9.999)
Process value is multiplied with this value.
Active if $\text{---Voltage / Current input}$ is selected.

unit Unit selection
 Unit °C
 Unit °F
 Unit is Voltage. Active if $\text{---Voltage / Current input}$ is selected
 No unit. Active if $\text{---Voltage / current input}$ is selected

LOL Operating Scale Minimum Value (Scale Low Point, Scale High Point)Unit
Used for Proportional band calculation and display blink.

UPL Operating Scale Maximum Value (Scale Low Point, Scale High Point)Unit
Used for Proportional band calculation and display blink.

UOF Display offset for process value (Scale -10%, Scale +10%)Unit This parameter value is added to the process value.

FLT Filter Time (0.0, 900.0)Second
Defines filter time for display value.

JCN Cold Junction Compensation
This parameter is active if process input is selected TC input.
 YES Cold junction compensation is active.
 NO Cold junction compensation is not active.

Scale: The difference, between high point and low point of the process input type. Example: If tCSL = 2 (low point is -200, high point is 900), then scale is 1100. If input type is Voltage/Current, then the scale is difference between tPoH and tPoL parameters.

pid ConF: PID Configuration Parameters

P-H PROPORTIONAL BAND (0.0, 999.9)%
If $\text{---UPL} = 1000\text{ }^\circ\text{C}$, $\text{---LOL} = 0\text{ }^\circ\text{C}$ and $\text{---P-H} = 50.0$
then Proportional Band = $(\text{---UPL} - \text{---LOL}) * \text{---P-H} / 100.0$
Proportional Band = $(1000-0)*50.0/100.0 = 500\text{ }^\circ\text{C}$

I-H INTEGRAL TIME (0, 3600)Second
Can be changed by the user. After completed the tuning correctly, integral time value changes automatically. If it is 0, integral control is deactivated.

D-H DERIVATIVE TIME (0.0, 999.9)Second
Can be changed by the user. After completed the tuning correctly, integral time value changes automatically. If it is 0, derivative control is deactivated.

CT-H CONTROL PERIOD TIME (1, 150)Second
Process output period time

OLH MINIMUM CONTROL OUTPUT (0.0, ---UOL)%
Even as a result of the PID calculation device calculates the %output value less than this parameter, heating or cooling output is active minimum for OLL parameter.

OLH MAXIMUM CONTROL OUTPUT (---OLH , 100.0)%
Even as a result of the PID calculation device calculates the % output value greater than this parameter, heating or cooling output is active maximum for OUL parameter.

OLH HEATING MINIMUM CONTROL OUTPUT TIME(0.0, ---CT-H)sec
Heating output can not be active less than this parameter. Even if this parameter is 0, this parameter is accepted 50 msec for security.

COE SOĞUTMA ORANSAL BAND KATSAYISI (0.0, 100.0)
If heating and cooling PID is used in a system, tune operation is performed by heating output. Cooling proportional parameter is calculated with heating proportional band value and coefficient (P-CL = P-H * COE / 100.0)

P-CL COOLING PROPORTIONAL BAND (000.0% , 999.9%)
If $\text{---UPL} = 1000\text{ }^\circ\text{C}$, $\text{---LOL} = 0\text{ }^\circ\text{C}$ and $\text{---P-CL} = 50.0$ ise
Proportional Band = $(\text{---UPL} - \text{---LOL}) * \text{---P-CL} / 100.0$
Proportional Band = $(1000-0)*50.0/100.0 = 500\text{ }^\circ\text{C}$

I-CL COOLING INTEGRAL TIME (0000 sec, 3600 secs)
It can be changed by the user. When tune operation finishes, it can be changed by the device. If it is 0, integral control part does not perform.

D-CL COOLING DERIVATIVE TIME (000.0 sec, 999.9 secs)
It can be changed by the user. When tune operation finishes, it can be changed by the device. If it is 0, derivative control part does not perform. When tune operation finishes if this parameter is 0, it can not be changed because derivative control part does not perform.

CT-CL COOLING OUTPUT PERIOD TIME (1 sec, 150 secs)
It is control period of cooling output.

OLL COOLING MINIMUM CONTROL OUTPUT(0.0, ---UOL)%
It is % of cooling minimum output. If heating and cooling PID control functions operate together, this parameter is not considered. Even as a result of the cooling PID calculation device calculates the output value less than this parameter, cooling output is active minimum OLLC parameter.

OLH COOLING MAXIMUM CONTROL OUTPUT (---OLH , 100.0)%
It is % of cooling maximum output. Even as a result of the cooling PID calculation device calculates the output value greater than this parameter, cooling output is active maximum for OULC parameter.

OLH COOLING MINIMUM CONTROL OUTPUT (0.0%, ---CT-CL)
Cooling output can not be active less than this parameter. Even if this parameter is 0, this parameter is accepted 50 msec for security.

RR ANTI-RESET WINDUP (0-SCALE HIGH POINT)UNIT
While PID operation is running if $\text{---PSE} - \text{---RR} \leq \text{process value} \leq \text{---PSE} + \text{---RR}$ condition is true, integral value is calculated. If the condition is not true, integral value is not calculated and last calculated integral value is used.

SUOF SETVALUEOFFSET
(-SCALE HIGH POINT / 2), (SCALE HIGH POINT / 2)Unit
 $\text{---PSE} + \text{---SUOF}$ is used as set value in PID calculations. This parameter is used for shifting the proportional band.

POFS PID OUTPUT OFFSET
(FOR HEATING PID 0.0, 100.0)%
(FOR COOLING PID -100.0, 0.0)%
(FOR HEATING&COOLING PID : -100.0, 100.0)%
This parameter is added to "Output %" which is calculated at the end of the PID.

POSS OUTPUT OFFSET RELATED TO PID SET
(FOR HEATING PID 0.0, 100.0)%
(FOR COOLING PID -100.0, 0.0)%
(FOR HEATING&COOLING PID : -100.0, 100.0)%
This parameter is added to the %process output that is calculated at the end of the PID according to process set value $\text{---POSS} * \text{---PSE} / (\text{---UPL} - \text{---LOL})$

SEEN PROCESS VALUE STABILIZATION (1. SCALE HIGH POINT)Unit
It is used for controlling if process value oscillates or not when ---UPL Parameter is ---REU or ---RES If; $\text{---PSE} - \text{---SEEN} \leq \text{Process Value} \leq \text{---PSE} + \text{---SEEN}$ condition is not true, then device start tune operation

SCALE LOW POINT : Minimum process input value in Pt-100 and Tc inputs. -1999 for fixed dual point display adjustment used inputs. Scale low point is the lowest one from ---UOL or for selectable dual point display adjustment used inputs Scale low point is the lowest one from ---POH or ---POL for multi point display adjustment used inputs
SCALE HIGH POINT : Maximum process input value in Pt-100 and Tc inputs. 9999 for fixed dual point display adjustment used inputs. Scale high point is the biggest one from ---UOL or ---UOH for selectable dual point display adjustment used inputs Scale high point is the biggest one from ---POH or ---POL for multi point display adjustment used inputs

ORDB PROPORTIONAL BAND SHIFTING ((-SCALE HIGH POINT / 2), (SCALE HIGH POINT / 2))Unit
If cooling function is performed ;
Cooling process set value is calculated by adding set value ---PSE With parameter ---ORDB
Control form can be ON/OFF or PID.

If set value for heating = $\text{---PSE} + \text{---SUOF}$;
Then set value for cooling = $\text{---PSE} + \text{---SUOF} + \text{---ORDB}$

SBOU SENSOR BREAK OUTPUT VALUE (FOR HEATING PID 0.0, 100.0)% (FOR COOLING PID -100.0, 0.0)%
When sensor breaks, controlling of the process can continue by entering %output value to ---SBOU parameter. If this parameter 0.0, process control output does not perform an output when sensor breaks.

ioP1 ConF: MODULE-1 Configuration Parameters

These parameters are active if EMO-400 (Relay Output) , EMO-410 (SSR Driver) or EMO-420 (Digital Output) module is plugged in Module-1 socket.

OUT1 Defines output function for Module-1
 HEAT Heating
 COOL Cooling
 LOGIC Logic output
 ON1 It is active if output function of Module-1 is heating or cooling.
 ONOFF ON/OFF
 PID PID

HYS1 Hysteresis value for OUT-1. It can be adjusted from 0% to 50% of defined scale. (It is active if ON/OFF control is selected.)

HYN1 It determines operation form of hysteresis. (ON/OFF)
 SV + HYS/2 and SV - HYS/2
 SV and SV + HYS or SV and SV - HYS

TRN1 In ON/OFF operation, this time must be passed for the output to be

LOU1 Logic output function of output module in Module-1
It is active if output function of Module-1 is Lout (Logic Output)

- Alarm output
- Manual /Automatic data output
- Sensor break alarm output
- Output is active when the process value is out of the band which is defined with minimum value of operating scale ---UPL And maximum value of operating scale ---LOL
- Output indicates that Ramp/Soak function has finished
- Sensor break alarm output for analogue input module in Module-2 socket. (It is visible if one of analogue input modules is plugged in Module-2 socket)

POH If process value is less than minimum value of operating scale for analogue input module in Module-2 socket or greater than maximum value of operating scale for analogue input module in Module-2 socket, process output becomes active. (This parameter is visible if one of the analogue input modules is plugged in Module-2 socket)

PLS1 Measurement input selection for Module-1 alarm output.
This parameter is visible if Logic output function of Module-1 is Alarm output and one of the analogue input modules is plugged in Module-2 socket

POH Alarm output runs according to the process input.
POI Alarm output runs according to the analogue input module (2nd sensor input) in Module-2 socket

AL1 MODULE-1 alarm
It determines alarm type. It is active if logic output function of Module-1 is an alarm output.

- PHIGH Process high alarm
- PLOW Process low alarm
- DEVHIGH Deviation high alarm
- DEVLLOW Deviation low alarm
- DEVBAND Deviation band alarm.
- DEVRANGE Deviation range alarm
- HEATER Heater failure alarm. It is active if \sim CT input module is plugged in Module-2 socket.

ALH1 MODULE-1 Alarm-1 hysteresis value.
It is active if logic output function of Module-1 is an alarm output.

ALON1 Alarm on delay time (0, 9999)Seconds
It is active if logic output function of Module-1 is an alarm output

ALOFF1 Alarm off delay time (0, 9998)Seconds
Alarm off delay time. It can be adjusted from 0000 to 9998 seconds. When the value is greater than 9998 ---ALH1 , is seen on the display. It means alarm latching output is selected.

ioP1 ConF: MODULE-1 Configuration Parameters

These parameters are active if EMO-x30 (0/4...20 mA --- Akım Çıkış) mmodule is plugged in Module-1 socket.

ORAL1 Configuration of analogue output module in odule-1
 0...20mA --- output is selected
 4...20mA --- output is selected
OUR1 Function selection of analogue output module in Module-1 socket.

HEAT Heating
 COOL Cooling.
 RETR Re-transmission

RETR1 MODÜL-1 re-transmission function
(It is active if "re-transmission" function is selected for analogue output module in Module-1 socket)

RETPR It retransmits Process value to analogue output.
 RETSE difference of the process value and the set value
 RETSV It retransmits Set value to analogue output.

ioP1 ConF: MODULE-1 Configuration Parameters

These parameters are active if EMI-400 (Digital Input) plugged in Module-1 socket.

- DIR1** Configuration of digital input in Module-1 socket.
- Manual /Automatic selection input
 - Auto Tune (Limit Cycle Tuning) Start/Stop input.
 - Ramp&Soak Start/Stop input.
 - Ramp&Soak Start/Hold input.
 - Alarm Latch Canceling.

ioP1 ConF:MODULE-1 Configuration Parameters

These parameters are active if EMI-410 (0/4...20mA current Input) , EMI-430 (TC or 0...50mV Input), EMI-X40 (PT-100 Input) or EMI-450 (0...10V Input) module is plugged in Module-1

5L Configuration of analogue input module in Module-1 socket.

0000 TC input type selection. This must be selected if analogue input module in Module-1 socket is EMI-430.

0001 PT-100 input type selection. This must be selected, if analogue input module in Module-1 socket is EMI-440.

0002 Voltage / Current input type selection. This must be selected if analogue input module in Module-1 socket is EMI-410 , EMI-430 or EMI - 450.

LC5L **MODULE-1TC** input module in Module-1 sensor type selection It is active if input type of Module-1 is selected TC.

- 0000** L (-100°C;850°C) or (-148°F;1562°F)
- 0001** L (-100.0°C;850.0°C) or (-148.0°F;999.9°F)
- 0002** J (-200°C;900°C) or (-328°F;1652°F)
- 0003** J (-199.9°C;900.0°C) or (-199.9°F;999.9°F)
- 0004** K (-200°C;1300°C) or (-328°F;2372°F)
- 0005** K (-199.9°C;999.9°C) or (-199.9°F;999.9°F)
- 0006** R (0°C;1700°C) or (32°F;3092°F)
- 0007** R (0.0°C;999.9°C) or (32.0°F;999.9°F)
- 0008** S (0°C;1700°C) or (32°F;3092°F)
- 0009** S (0.0°C;999.9°C) or (32.0°F;999.9°F)
- 0010** T (-200°C;400°C) or (-328°F;752°F)
- 0011** T (-199.9°C;400.0°C) or (-199.9°F;752.0°F)
- 0012** B (44°C;1800°C) or (111°F;3272°F)
- 0013** B (44.0°C;999.9°C) or (111.0°F ; 999.9°F)
- 0014** E (-150°C;700°C) or (-238°F;1292°F)
- 0015** E (-150.0°C;700.0°C) or (-199.9°F;999.9°F)
- 0016** N (-200°C;1300°C) or (-328°F;2372°F)
- 0017** N (-199.9°C;999.9°C) or (-199.9°F;999.9°F)
- 0018** C (0°C;2300°C) or (32°F;3261°F)
- 0019** C (0.0°C;999.9°C) or (32.0°F;999.9°F)

LC5P **MODULE-1 PT-100** input module in Module-1 sensor type selection It is active if input type of Module-1 is selected PT-100

0000 PT-100 (-200°C ; 650°C) or (-328°F ; 1202°F)

0001 PT-100 (-199.9°C ; 650.0°C) or (-199.9°F ; 999.9°F)

ARS **MODÜL-1 Voltage/Current Input Module Selection**
It is active if input type of Module-1 is selected Voltage/Current

- 0000** 0...50mV (-1999 ; 9999)
- 0001** 0...5V (-1999 ; 9999)
- 0002** 0...10V (-1999 ; 9999)
- 0003** 0...20mA (-1999 ; 9999)
- 0004** 4...20mA (-1999 ; 9999)

DPn **point position for display**
It is active if input type of Module-1 is selected Voltage /Current

- 0000** No point
- 0001** 000.0
- 0002** 00.00
- 0003** 0.000

LCR **Calibration type**
It is active if input type of Module-1 is selected Voltage /Current.

- 0000** Fixed dual point calibration is performed. Minimum value of calibration is -1999 and maximum value of calibration is 9999.
- 0001** Selectable dual point calibration is performed.

LC Defines minimum value for selectable dual point calibration. It is active if input type of Module-1 is selected Voltage /Current.

CH Defines maximum value for selectable dual point calibration. It is active if input type of Module-1 is selected Voltage /Current.

Unit Unit selection
 Unit is °C
 Unit is °F
 Unit is U.
 No unit.

LC Minimum value of operating scale (Low Limit). It can be changed according to analogue input type and scale.

HP Maximum value of operating scale (High Limit). It can be changed according to analogue input type and scale

PU Display offset for value in analogue input module. It can be adjusted from -10% to +10% of scale. This value is added to the process value.

FL It is filter time for input signal. It can be adjusted from 0.0 to 900.0

LCJn It decides if cold junction compensation is active or not for TC input module in Module-1 socket. It is active if process input of Module-1 is TC input.

YES Cold junction compensation is active
 NO Cold junction compensation is not active

LCES It determines if the measured value from analogue input module in Module-1 socket is used as Remote Set or not. This parameter is visible if point position and unit parameters are same for process input and analogue input module.

YES Measured value from analogue input module in Module-1 socket is used as process set value. User defined process set value is not considered

NO Measured value from analogue input module in Module-1 socket is not used as process set value. User defined process set value is considered

ioP1 ConF: MODULE-1 Configuration Parameters

These parameters are active if EMI-420 (~ CT) Input Module is plugged in Module-1 socket.

CTR Current transfer ratio for Module-1. It can be adjusted from 0 to 100.

Example : For 100:5A type current transformer ;This parameter must be Ctr1= 100/5 = 20

ioP2 ConF: MODULE-2 Configuration Parameters

All the functions that apply for module-1, module-2 applies to.

out3 ConF: Output-3 Configuration Parameters

OUT3 Defines output function for Output-3

- Heating
- Cooling
- Logic output

CON3 Defines control algorithm of Output-3.
It is active if output function of Output-3 is heating or cooling

ON/OFF control algorithm
 PID control algorithm

HYS3 Hysteresis value for OUT-3. It can be adjusted from 0% to 50% of defined scale. (It is active if ON/OFF control is selected)

HYN3 It determines operation form of hysteresis. (It is active if ON/OFF control is selected)

SV+ HYS/2 and SV- HYS/2
 SV and SV+HYS or SV and SV-HYS

EN3 In ON/OFF operation, this time must be passed for the output to be energised again. (It is active if ON/OFF control is selected)

LOU3 It determines logic output function of Output-3.
It is active if output function of Output-3 is Lout(Logicoutput)

0000 Alarm output
0001 Manual /Automatic data output
0002 Sensor break alarm output

0003 POutput is active when the process value is out of the band which is defined with minimum value of operating scale **LC** And maximum value of operating scale **HP**

0004 Output indicates that Ramp/Soak function has finished

0005 Sensor break alarm output for analogue input module in Module-1or Module-2 socket. (It is visible if one of analogue input modules is plugged in Module-1 or Module-2 socket)

0006 If process value is less than minimum value of operating scale or for analogue input module in Module-1 or Module-2 socket or greater than maximum value of operating scale or for analogue input module in Module-1 or Module-2 socket, process output becomes active.(This parameter is visible if one of the analogue input modules is plugged in Module-1 or Module-2 socket)

RLS3 **Measurement input selection for Output-3 alarm output.**
This parameter is visible if Logic output function of Output-3 is Alarm output and one of the analogue input modules is plugged in Module-1 or Module-2 socket

0000 Alarm output runs according to the process input
0001 Alarm output runs according to the analogue input module (2nd sensor input) in Module-1 or Module-2 socket.

RLT3 It determines alarm
It is active if logic output function of Output-3 is alarm output.

0000 Process high alarm
0001 Process low alarm
0002 Deviation high alarm.
0003 Deviation low alarm.
0004 Deviation band alarm.
0005 Deviation range alarm

0006 Isıtıcı Arızası Alarmı. It is active if ~CT input module is plugged in Module-1 or Module-2 socket.

RLH3 **Alarm-3 hysteresis value. (Scale 0% , scale 50%)Unit**
It is active if logic output function of Output-3

ROn3 **Alarm on delay time(0, 999)Seconds**
It is active if logic output function of Module-1 is alarm output.

ROF3 **Alarm off delay time (0, 999)Seconds**
When the value is than 9998, **LCCH** is seen on the display. It means alarm latching output is selected. It is active if logic output function of Output-3 is alarm output.

Alarm Types

Process high alarm

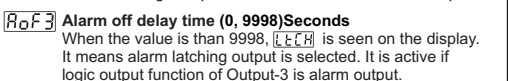

Process low alarm



Alarm Types

Deviation high alarm

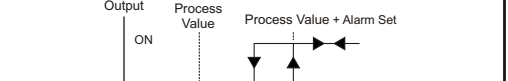

Deviation low alarm

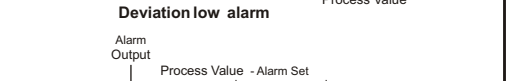

Deviation Band Alarm

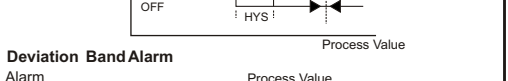

Deviation Range Alarm

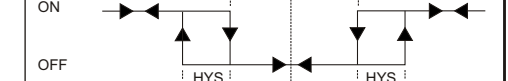

Gen ConF: General Parameters

5U-L Minimum value for process set and alarm set values

5U-U Maximum value for process set and alarm set values

5UL2 **2. Sensor Set Point Low Limit** .sensor scale min. **5U-L2**)
2. Sensor Unit
Module-1 or Module-2 socket Analog Input Modules.
(If you have any of these parameters is observed)

5UH2 **2. Sensor Set Point High Limit** .sensor scale min. **5U-U2**)
2. Sensor Unit
Module-1 or Module-2 socket Analog Input Modules.
(If you have any of these parameters is observed)

ULLT **While the motor is completely off the valve fully open**
While the fully open or fully closed for the pass time required. Value between 5 and 600 seconds can be entered.
(If motorized valve control is selected this parameter is active)

ULHY **The minimum duration of the valve motor drive output (0.1, 5.0)**
Ultt = 100 sec and **ULHY** = %1.0 and the motor driving the valve output. The minimum time to be active in 100 * 1.0% = 1 sec.
(If motorized valve control is selected this parameter is active)

Com ConF: Parameters for Configuration of Serial Communication

5ADR **Communication Accessing Address (1,247)**
Communication accessing address of device. It can be adjusted from 1 to 247.

BRUD **Communication Baud Rate**

- 0000** 1200 Baud Rate.
- 0001** 2400 Baud Rate .
- 0002** 4800 Baud Rate
- 0003** 9600 Baud Rate
- 0004** 19200 Baud Rate

Com ConF: Parameters for Configuration of Serial Communication

Parity Selection for Communication

- 0000 No parity.
- 0001 Odd parity.
- 0002 Even parity.

Stop Bit Selection for Communication

- 0000 1 stop bit
- 0001 2 stop bit

PASS ConF: Operator and Technician Passwords

Operator Passwords (0, 9999)

It is used for accessing to the operator parameters. If it is 0000, no password protection while entering to the operator Parameters.

If it is different from "0" and user wants to access to the operator parameters;

- 1- If user does not enter password correctly :It turns to operation screen without accessing to parameters.
- 2- When in top display and in bottom display are seen, if user presses SET button without entering Password (For observing the parameters): Operator can see operator menus and parameters but operator can not change the parameters

Technician Passwords(0, 9999)

It is used for accessing to the technician parameters. If it is 0000 no password protection while entering to the technician Parameters.

If it is different from "0" and user wants to access to the technician parameters;

- 1- If user does not enter password correctly :It turns to operation screen without accessing to parameters. When in top display and in bottom display are seen, if user presses SET button without entering Password (For observing the parameters): Operator can see operator menus and parameters but operator can not change the parameters.

Failure Messages in ESM-XX50 Process Controllers

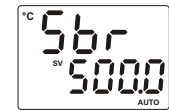

1- Sensor failure in analogue inputs. Sensor connection is wrong or there is no sensor connection.

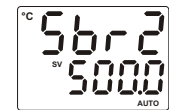

2- If parameter in "Disp List" menu is and analogue input module is plugged in Module-1 or Module-2 socket, this is sensor failure of analogue input module. Sensor connection is wrong or there is no sensor connection.

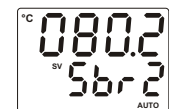

3- If parameter is and parameter is and analogue input module is plugged in Module-1 or Module-2 socket, this is sensor failure of analogue input module. Sensor connection is wrong or there is no sensor connection.

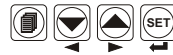
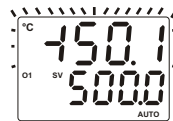

4- If top display blinks : If analogue input value is less than minimum value of operating scale top display starts to blink.

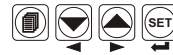
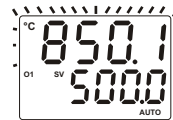

5- If top display blinks : If analogue input value is greater than maximum value of operating scale top display starts to blink.

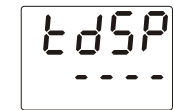

6- If operator or technician password is different from "0" and user accesses to the parameter by Set button without entering the operator or technician password and wants to change a parameter, the warning message is shown on the bottom display as shown on the left. Device does not allow to do any changes without entering the password correctly.

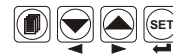

7- If tuning operation can not be completed in 8 hours, AT led starts to blink. Blinking can be canceled by pressing Enter button.



8- If user does not do anything for 120 seconds while device is on operator or technician menus, device turns to operation screen.

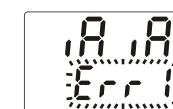

9- The device is powered up, the normal does not begin to run, and the bottom of the screen as the side flashing; Module-1 and Module-2 slots, EMIX10 EMI-X30, X40-EMI, EMI-X50 Analog input modules installed at the same time the event occurs. The unit normal to return to work, the device energy cut-off and Analog Input one of the modules must be removed.

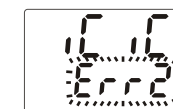

10- When power is on ; not starting the normal operation and blinking the bottom display as shown on the left; It appears when two analogue input modules (EMI-410, EMI-430, EMI-440, EMI-450) are plugged in Module-1 and Module-2 socket at the same time. For starting normal operation power off and pull out one of the analogue input modules.

Installation



Before beginning installation of this product, please read the instruction manual and warnings below carefully.

- In package ,
- One piece unit
 - Twopiece mounting clamp
 - One piece instruction manual

A visual inspection of this product for possible damage occurred during shipment is recommended before installation. It is your responsibility to ensure that qualified mechanical and electrical technicians install this product.

If there is danger of serious accident resulting from a failure or defect in this unit, power off the system and separate the electrical connection of the device from the system.

The unit is normally supplied without a power switch or a fuse. Use power switch and fuse as required.

Be sure to use the rated power supply voltage to protect the unit against damage and to prevent failure.

Keep the power off until all of the wiring is completed so that electric shock and trouble with the unit can be prevented.

Never attempt to disassemble, modify or repair this unit. Tampering with the unit may result in malfunction, electric shock or fire.

Do not use the unit in combustible or explosive gaseous atmospheres.

During the equipment is put in hole on the metal panel while mechanical installation some metal burrs can cause injury on hands, you must be careful.

Montage of the product on a system must be done with its own fixing clamps. Do not do the montage of the device with inappropriate fixing clamps. Be sure that device will not fall while doing the montage.

It is your responsibility if this equipment is used in a manner not specified in this instruction manual.

Warranty

EMKO Elektronik warrants that the equipment delivered is free from defects in material and workmanship. This warranty is provided for a period of two years. The warranty period starts from the delivery date. This warranty is in force if duty and responsibilities which are determined in warranty document and instruction manual performs by the customer completely.

Maintenance

Repairs should only be performed by trained and specialized personnel. Cut power to the device before accessing internal parts. Do not clean the case with hydrocarbon-based solvents (Petrol, Trichlorethylene etc.). Use of these solvents can reduce the mechanical reliability of the device. Use a cloth dampened in ethyl alcohol or water to clean the external plastic case.

Other Informations

Manufacturer Information:

Emko Elektronik Sanayi ve Ticaret A.Ş.
 Demirtaş Organize Sanayi Bölgesi Karanfil Sk. No:6 16369
 BURSA / TURKEY
 Phone : +90 224 261 1900
 Fax : +90 224 261 1912

Repair and maintenance service information:

Emko Elektronik Sanayi ve Ticaret A.Ş.
 Demirtaş Organize Sanayi Bölgesi Karanfil Sk. No:6 16369 BURSA
 BURSA / TURKEY

Phone : +90 224 261 1900

Fax : +90 224 261 1912

Ordering Information

ESM-4450 (48x48 DIN 1/8)	A	B	C	D	E	/	FG	HI	/	U	V	W	Z
ESM-4950 (96x48 DIN 1/8)													
ESM-7750 (72x72 DIN Sizes)													
ESM-9950 (96x96 DIN 1/4)													
ESM-9450 (48x96 DIN 1/8)													

A	Supply Voltage
1	100-240V ~ (-15%;+10%) 50/60Hz
2	24V ~ (-15%;+10%) 50/60Hz 24V === (-15%;+10%)
9	Customer (Maximum 240V ~ (-15%;+10%)50/60Hz

BC	Input Type	Scale
20	Configurable(Tablo-1)	Table-1

D	Serial Communication	Product Code
0	None	-
1	RS-232	EMC-X00
2	RS-485	EMC-X10

E	Output-1 (Alarm)
1	Relay Output (5A@250V~at Resistive Load)

FG	Module-1	Product Code
00	None	-
01	Relay Output Module	EMO-X00
02	SSR Driver Output Module	EMO-X10
03	Digital (Transistor) Output Module	EMO-X20
04	Current Output Module (0/4 ...20 mA ===)	EMO-X30
07	Digital Input Module	EMI-X00
08	0/4...20 mA === Current Input Module	EMI-X10
09	0...5A ~ CT Input Module	EMI-X20
10	TC veya 0...50mV === Input Module	EMI-X30
11	PT-100 Input Module	EMI-X40
12	0...10 V === Input Module	EMI-X50

HI	Module-2	Ürün Kodu
00	None	-
01	Relay Output Module	EMO-X00
02	SSR Driver Output Module	EMO-X10
03	Digital (Transistor) Output Module	EMO-X20
04	Current Output Module (0/4 ...20 mA ===)	EMO-X30
07	Digital Input Module	EMI-X00
08	0/4...20 mA === Current Input Module	EMI-X10
09	0...5A ~ CT Input Module	EMI-X20
10	TC veya 0...50mV === Input Module	EMI-X30
11	PT-100 Input Module	EMI-X40
12	0...10 V === Input Module	EMI-X50

BC	Input Type(TC)	Scale(°C)	Scale(°F)
21	L ,Fe Const DIN43710	-100°C,850.0°C	-148°F ,1562°F
22	L ,Fe Const DIN43710	-100.0°C, 850.0°C	-148.0°F,999.9°F
23	J ,Fe CuNi IEC584.1(ITS90)	-200°C,900.0°C	-328°F,1652°F
24	J ,Fe CuNi IEC584.1(ITS90)	-199.9°C,900.0°C	-199.9°F,999.9°F
25	K ,NiCr Ni IEC584.1(ITS90)	-200°C,1300°C	-328°F,2372°F
26	K ,NiCr Ni IEC584.1(ITS90)	-199.9°C,999.9°C	-199.9°F,999.9°F
27	R ,Pt13%Rh Pt IEC584.1(ITS90)	0°C,1700°C	32°F,3092°F
28	S ,Pt10%Rh Pt IEC584.1(ITS90)	0°C,1700°C	32°F,3092°F
29	T ,Cu CuNi IEC584.1(ITS90)	-200°C,400.0°C	-328°F,752°F
30	T ,Cu CuNi IEC584.1(ITS90)	-199.9°C,400.0°C	-199.9°F,752.0°F
31	B ,Pt30%Rh Pt6%Rh IEC584.1(ITS90)	44°C,1800°C	111°F,3272°F
32	B ,Pt30%Rh Pt6%Rh IEC584.1(ITS90)	44.0°C,999.9°C	111.0°F,999.9°F
33	E ,NiCr CuNi IEC584.1(ITS90)	-150°C,700°C	-238°F,1292°F
34	E ,NiCr CuNi IEC584.1(ITS90)	-150.0°C,700.0°C	-199.9°F,999.9°F
35	N ,Nicrosil Nisil IEC584.1(ITS90)	-200°C,1300°C	-328°F,2372°F
36	N ,Nicrosil Nisil IEC584.1(ITS90)	-199.9°C,999.9°C	-199.9°F,999.9°F
37	C ,(ITS90)	0°C,2300°C	32°F,3261°F
38	C ,(ITS90)	0.0°C,999.9°C	32.0°F,999.9°F

BC	Input Type(RTD)	Skala(°C)	Scale(°F)
39	PT 100 ,IEC751(ITS90)	-200°C,650.0°C	-328°F,1202°F
40	PT 100 ,IEC751(ITS90)	-199.9°C,650.0°C	-199.9°F,999.9°F

BC	Input Type(=== Voltage and Current)	Scale
41	0...50 mV ===	-1999,9999
42	0...5 V ===	-1999,9999
43	0...10 V ===	-1999,9999
44	0...20 mA ===	-1999,9999
45	4...20 mA ===	-1999,9999