



ENGLISH

Datasheet

New 5.0mm Header Vertical 15A 4 way

RS Stock 874-4859



Dimensions: (mm)

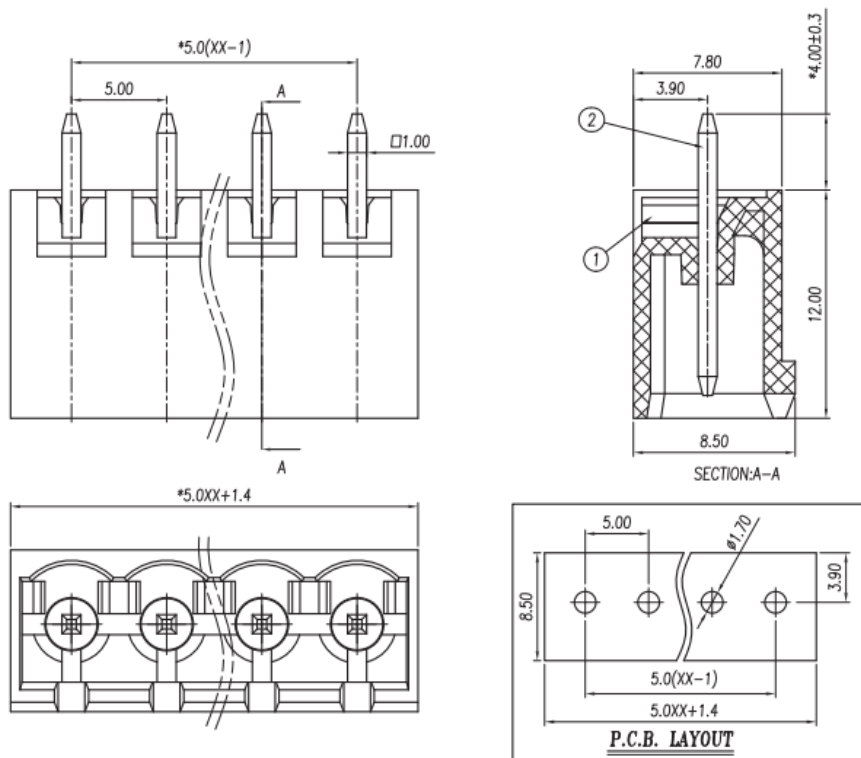



Electrical

Standard	UL	IEC
Rated voltage	300V	450V
Rated current	15A	17.5A
Contact resistance	20mΩ	
Insulation resistance	500MΩ/DC500V	
Wrth standing voltage	AC 2000V/1 Min	

Mechanical

Temp.Range	-40°C~+105°C
MAX Soldering	+250°C, for 5 Sec

Dimensions

Pitch	5.0mm
Poles	02~24p

Material

Housing	PA66, UL94V-0
Pin header	Brass, Tin plated