

Datasheet

3 way PCB terminal block 15.0mm

RS Stock 790-1180



Dimensions: (mm)

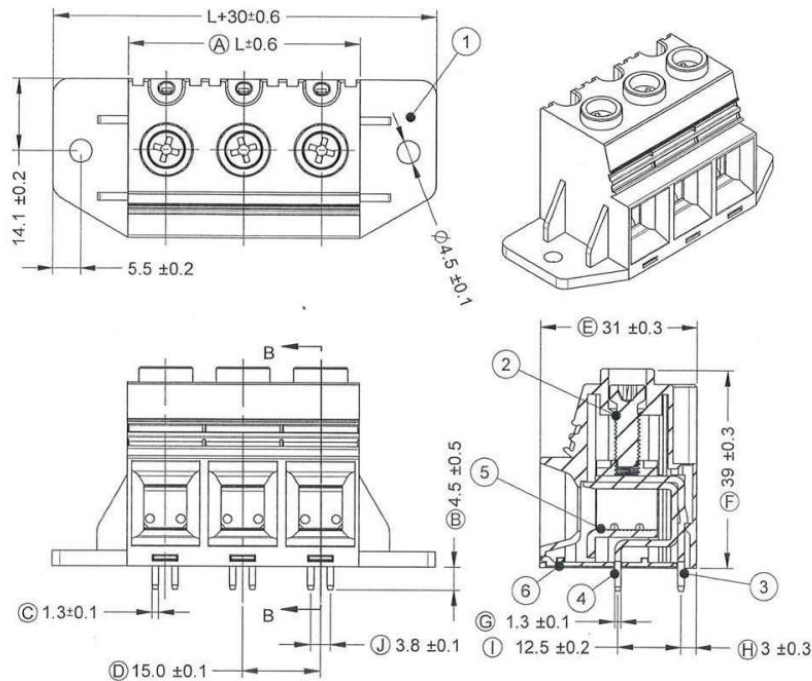

Specification

Current Rating: 15Amp AC300V
 Insulation Withstands Volts: AC2000V Min
 Insulation Resistance: >2000M Ω DC500V
 Operation Temperature: -40°C to + 105°C

Material

Insulating Body: Polyamide 66(UL94V-0)
 Screw: Steel / Finish: Zinc + Cr+3
 Terminal: Copper / Tin Plated
 Terminal: Copper / Tin Plated
 Cage Clamp: Steel / Zinc + CR+3
 RoHS Compliant