

Sep.1.2019 Copyright 2019 HIROSE ELECTRIC CO., LTD. All Rights Reserved.
 In case of consideration for using Automotive equipment / device which demand high reliability, kindly contact our sales window correspondents.

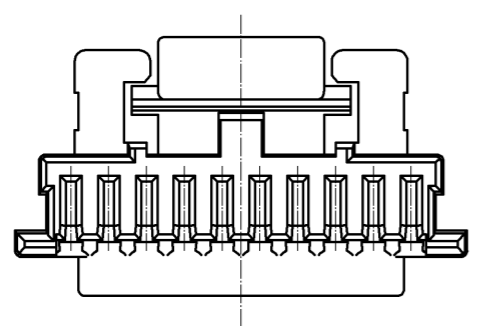
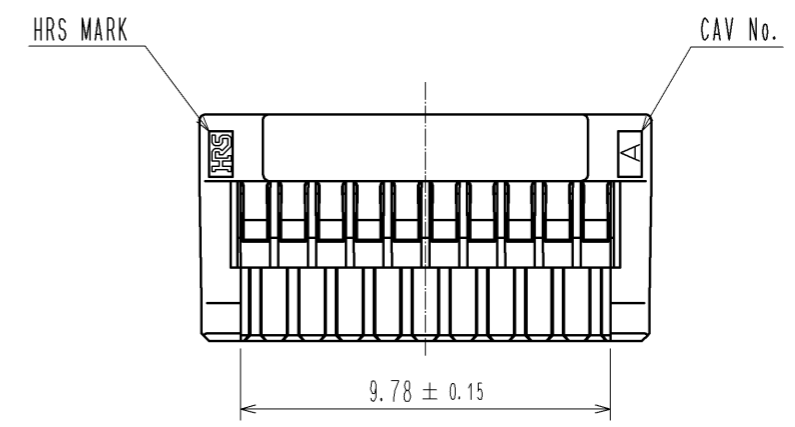
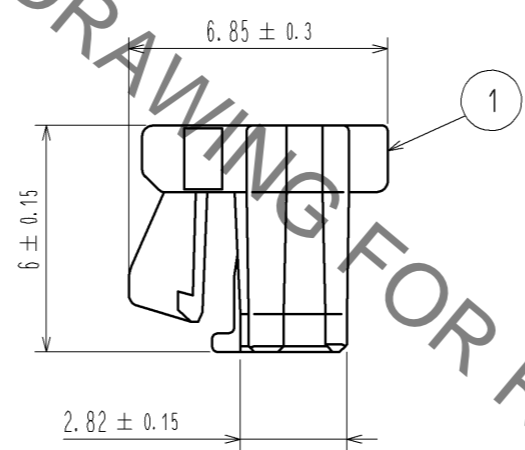
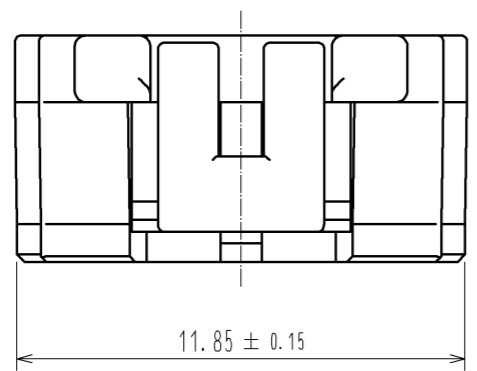
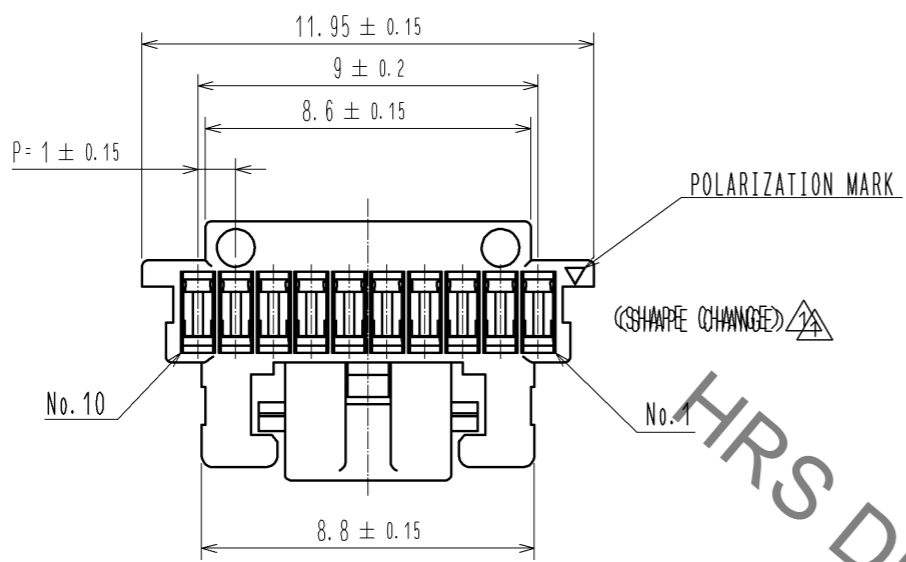

HRS DRAWING FOR REFERENCE

NOTE1. PER PACK:100 PIECES

NO.		MATERIAL		FINISH . REMARKS		1	PBT	UL94V-0. BLACK		
UNITS mm		SCALE 5 : 1		COUNT 1		DESCRIPTION OF REVISIONS DIS-H-005903		DESIGNED KT. ISHII	CHECKED OM. MIYAMOTO	DATE 11.06.16
HIROSE ELECTRIC CO., LTD.		APPROVED : KI. AKIYAMA		10.12.14		DRAWING NO.		EDC3-329672-00		
		CHECKED : OM. MIYAMOTO		10.12.14		PART NO.		DF50A-10S-1C		
		DESIGNED : TT. OHSAKO		10.12.13		CODE NO.		CL665-1018-6-00		
		DRAWN : TT. OHSAKO		10.12.13						