

DETAILS

Product Number	C13871_VANESSA-B-O
Family	Vanessa
Type	Lens
Color	clear
Diameter	295x16 mm
Height	8 mm
Style	rectang
Optic Material	PMMA
Holder Material	
Fastening	
Status	ready
ROHS Compliant	Yes
Date Updated	17/04/2015

OPTICAL PROPERTIES

LED	Viewing	Light	Effi-		Connector
	Angle	Beam	ciency	cd/lm	
XB-D	sim: 50+19	Oval	sim: 83 %	sim: 1.900	-
Oslon Square EC	45+20 deg	Oval	90 %	1.780	-
XP-E	45+18 deg	Oval	88 %	2.100	-
LUXEON Rebel ES	45+21 deg	Oval	89 %	1.800	-
XP-G	46+21 deg	Oval	87 %	1.700	-
XP-G2	46+21 deg	Oval	88 %	1.790	-



H G F E D C B A

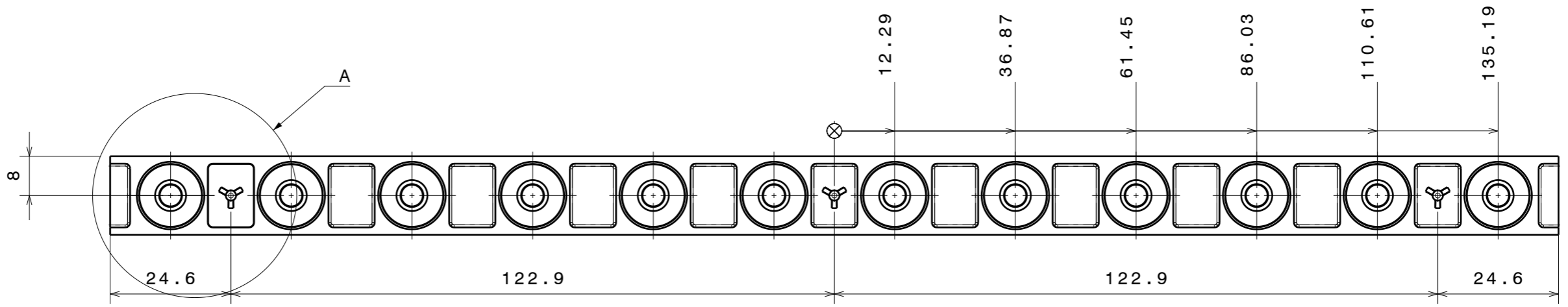

Isometric view
Scale: 1:2

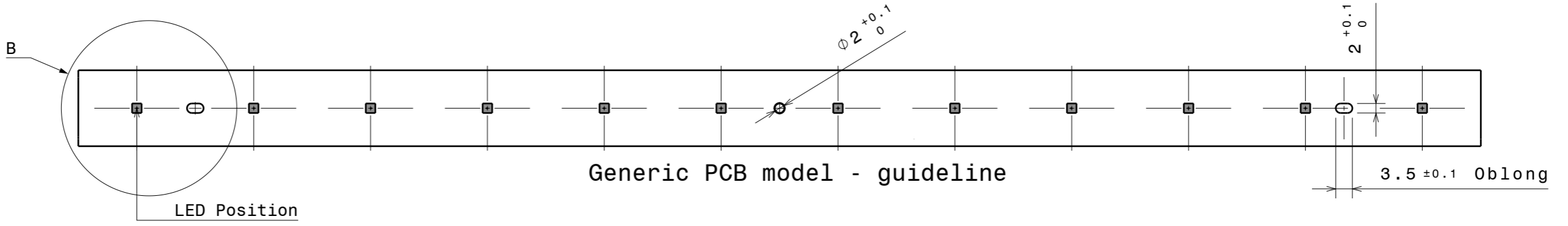
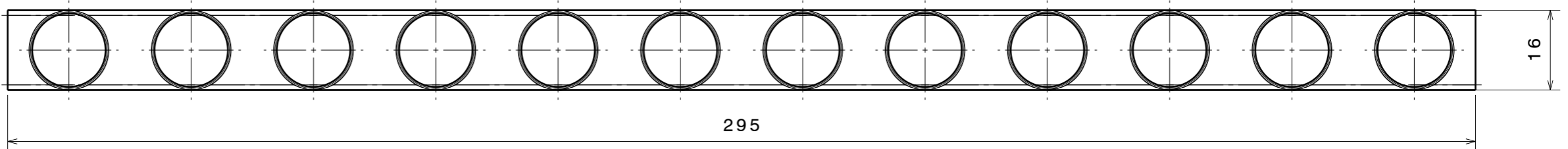
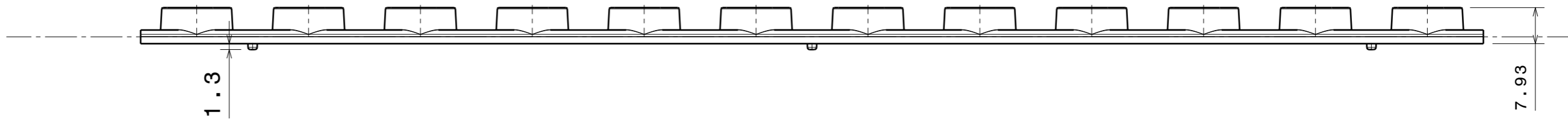
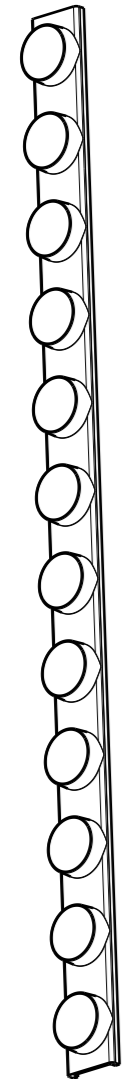

Generic PCB model - guideline

LED Position

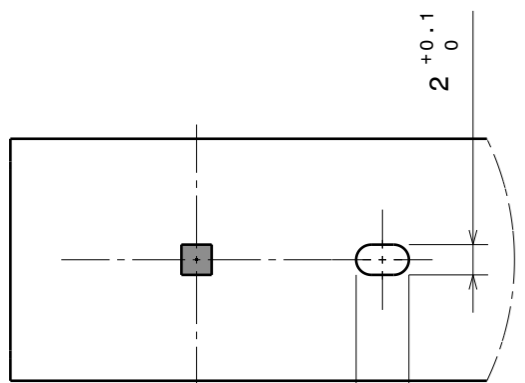

Detail B
Scale: 2:1

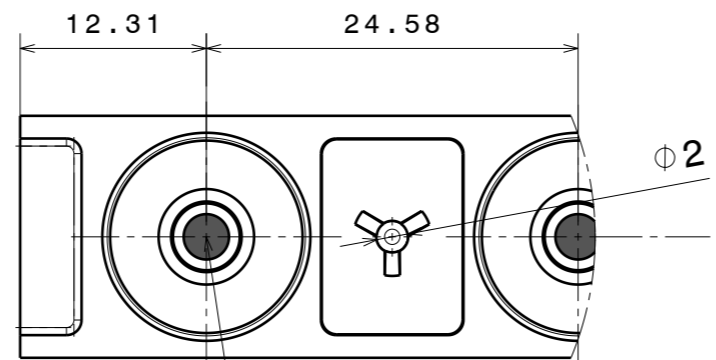

Detail A
Scale: 2:1

LED position

Tolerances if not otherwise shown
Linear measures: class C
according to DIN ISO 2768-1
Form and position: class L
according to DIN ISO 2768-2

THIRD ANGLE PROJECTION:

This drawing is the property of LEDiL Oy. It may not be reproduced, copied or communicated without a written agreement with LEDiL Oy."

INDEX	PART NO	DESCRIPTION	MATERIAL	COLOUR
1	Datasheet	VANESSA	PMMA	Clear

LEDiL LediL Oy
Salorankatu 10
FIN 24240 SALO
Finland

DRAWING TITLE
Datasheet_VANESSA

SIZE PART NUMBER
A3 -

SCALE 1:1 WEIGHT (g) SHEET 1/1

H G B A

Luminaire: LEDiL Oy C13871_VANESSA-B-O (SQ-EC)

Lamps: 1 x Osram_Square_EC_962.49lm@250mA_P=8.83543W_I=249.8mA

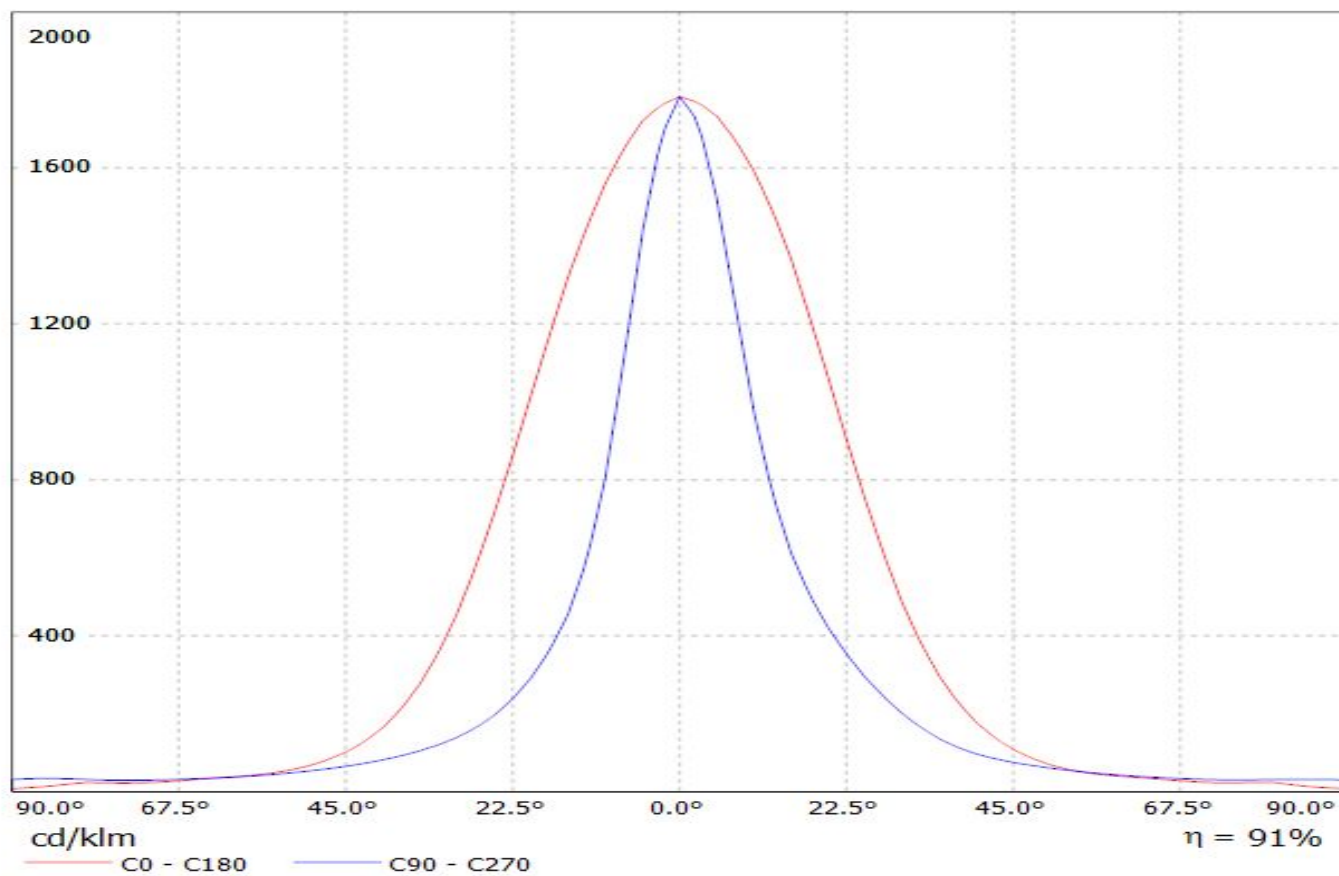

Luminaire: LEDiL Oy C13871_VANESSA-B-O_(XP-E)
Lamps: 1 x CREE_XP-E_12x1 910lm@250mA

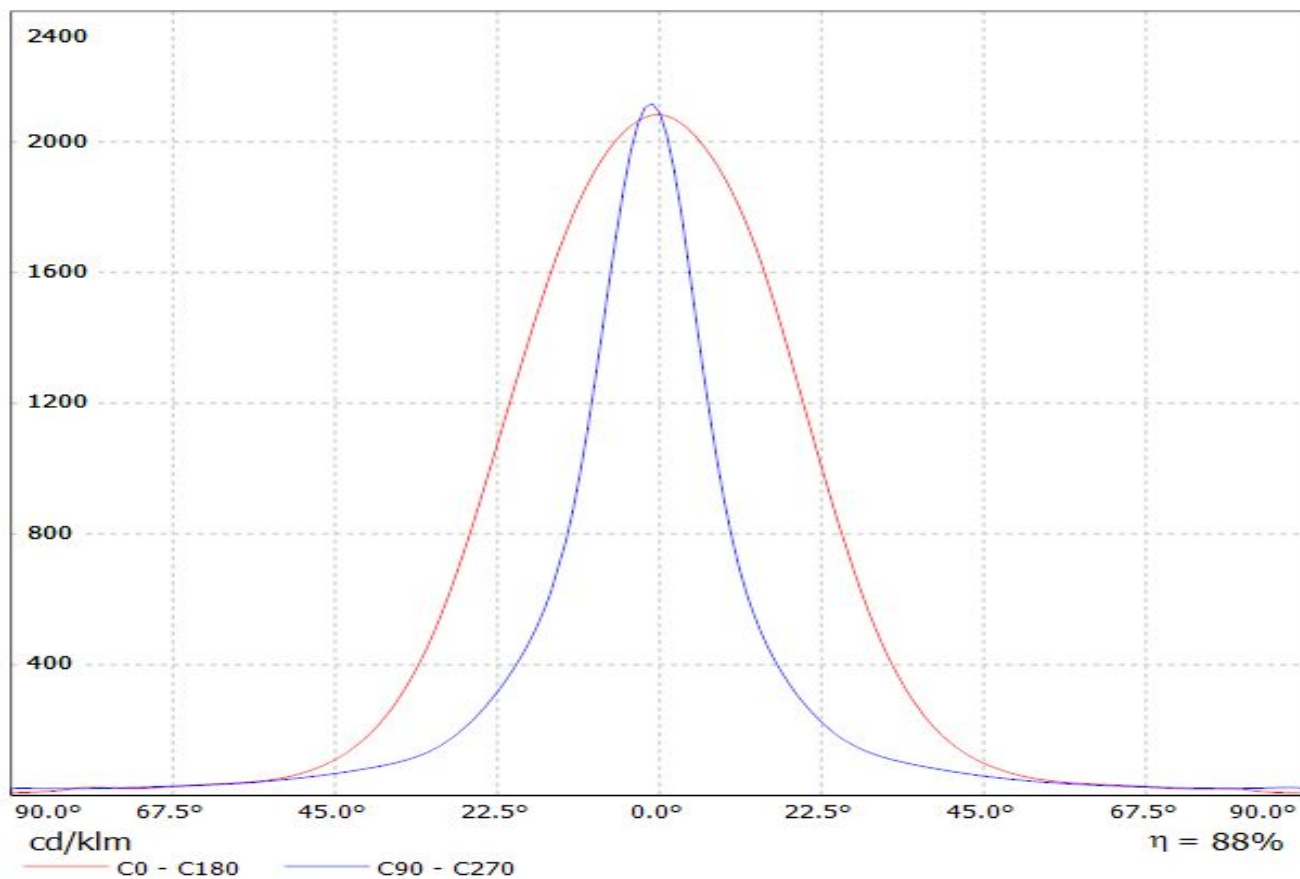

Luminaire: LEDiL Oy C13871_VANESSA-B-O_(REBEL-ES)
Lamps: 1 x REBEL-ES_12x1_811@250mA_P=9.07798W_I=249.8mA

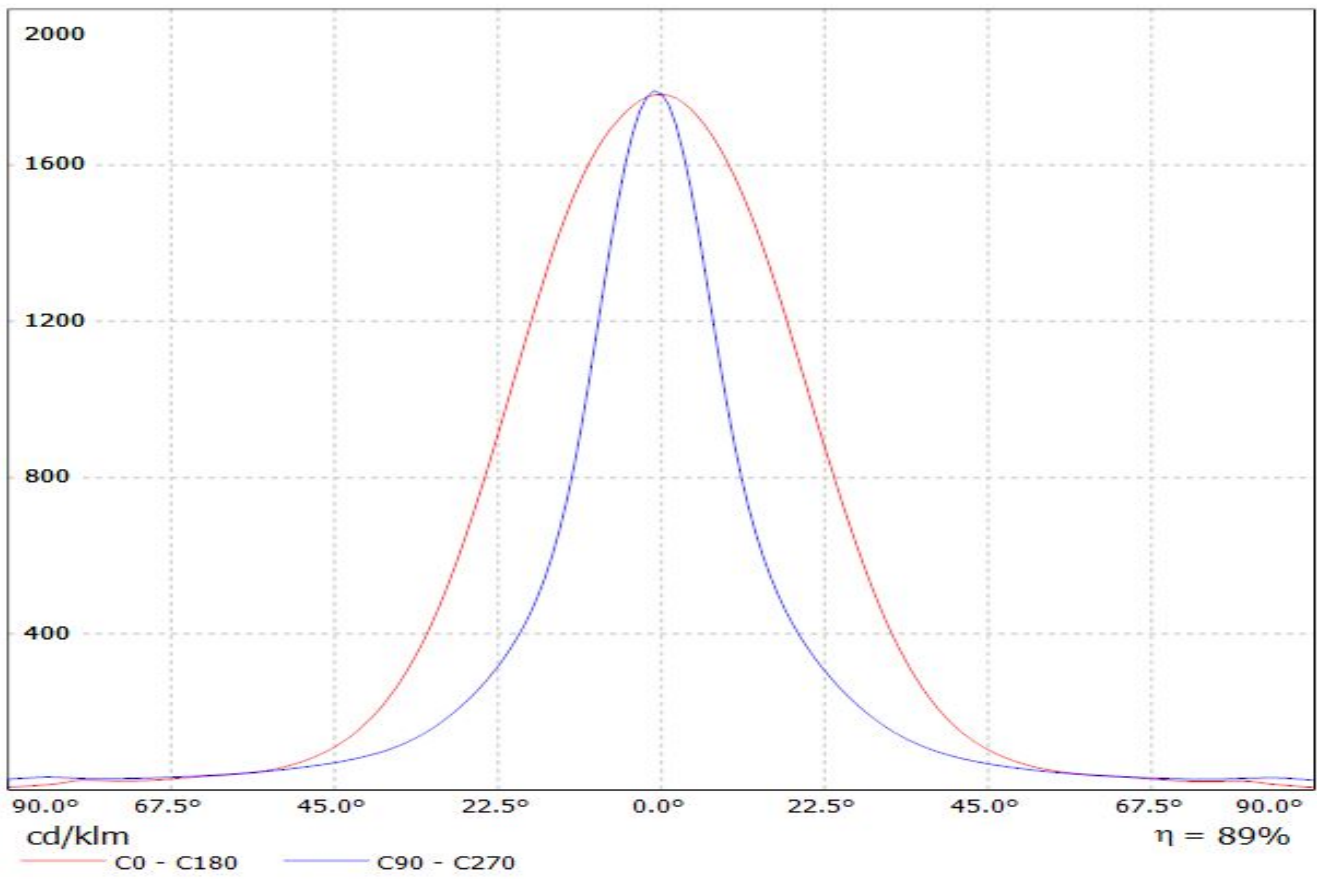

Luminaire: LEDiL Oy C13871_VANESSA-B-O_(XP-G)

Lamps: 1 x CREE_XP-G_(XPGWHT-L1-4C0-R5-0-09)_1113.14lm@250mA_P=8.48621W_I=249.8mA

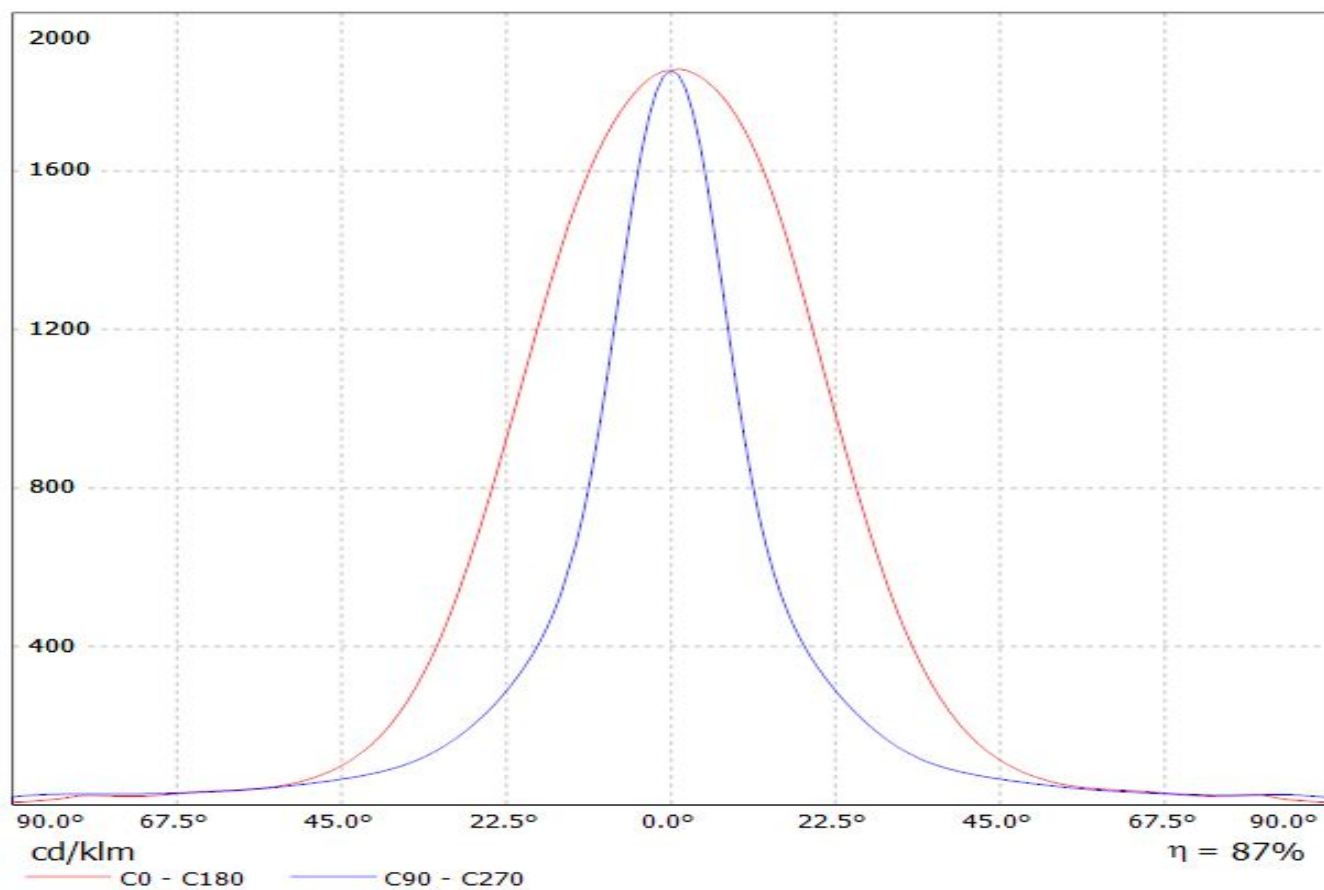

Luminaire: LEDiL Oy C13871_VANESSA-B-O_(XP-G2)
Lamps: 1 x CREE_XP-G2_12x1_1174.06@250mA_P=8.65107_I=249.8mA

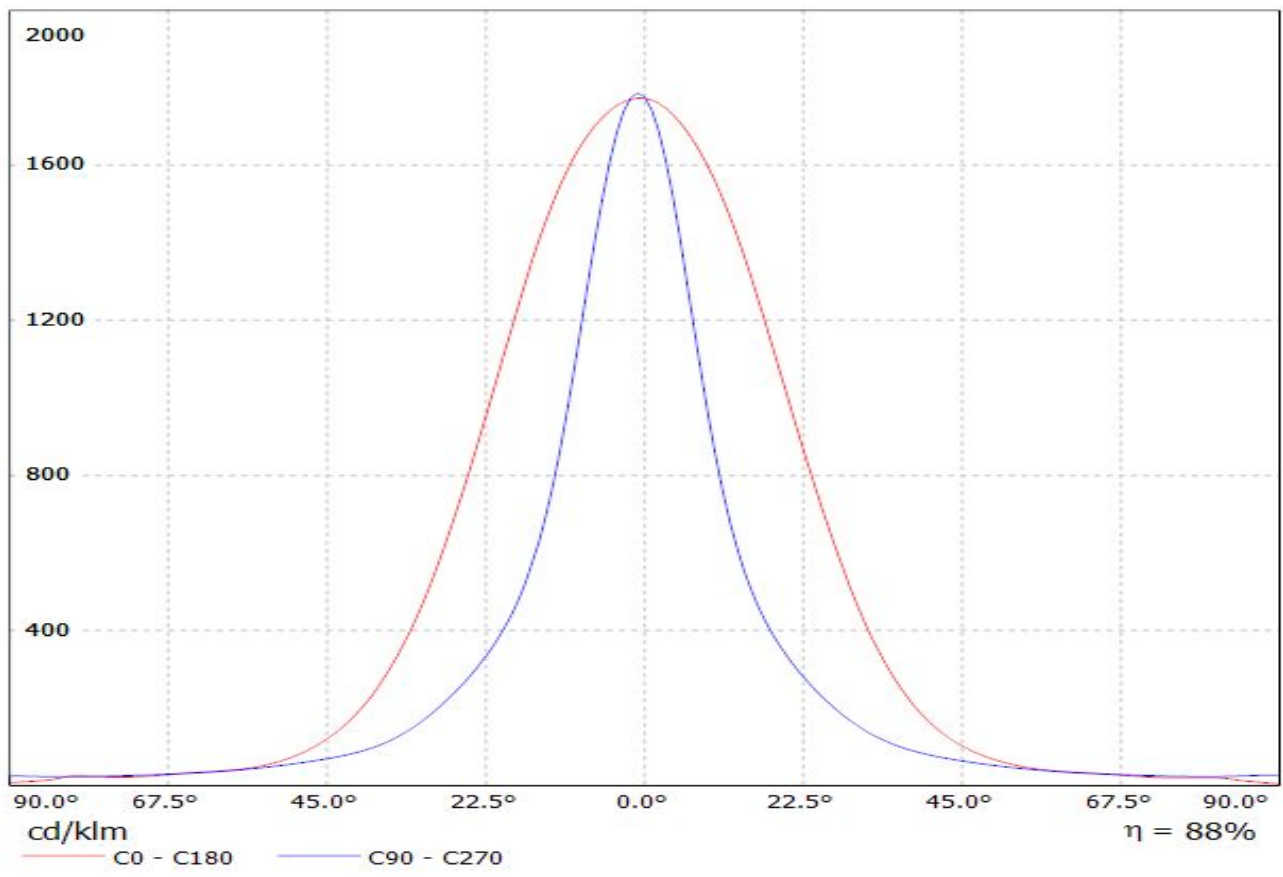

Luminaire: LEDiL Oy C13871_VANESSA-B-O_(SQ-EC)

Lamps: 1 x Osram_Square_EC_962.49lm@250mA_P=8.83543W_I=249.8mA

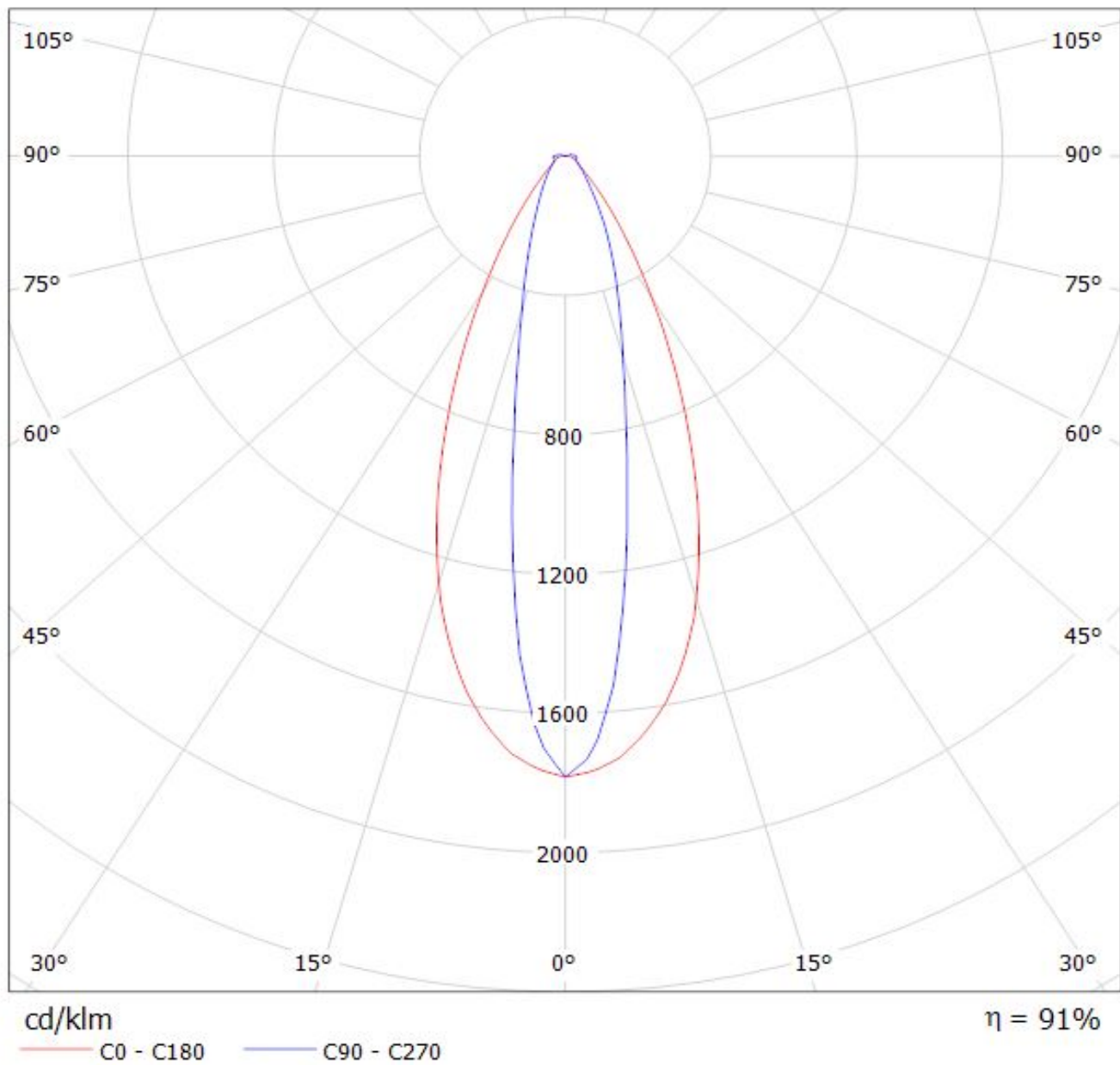

Luminaire: LEDiL Oy C13871_VANESSA-B-O_(XP-E)
Lamps: 1 x CREE_XP-E_12x1 910lm@250mA

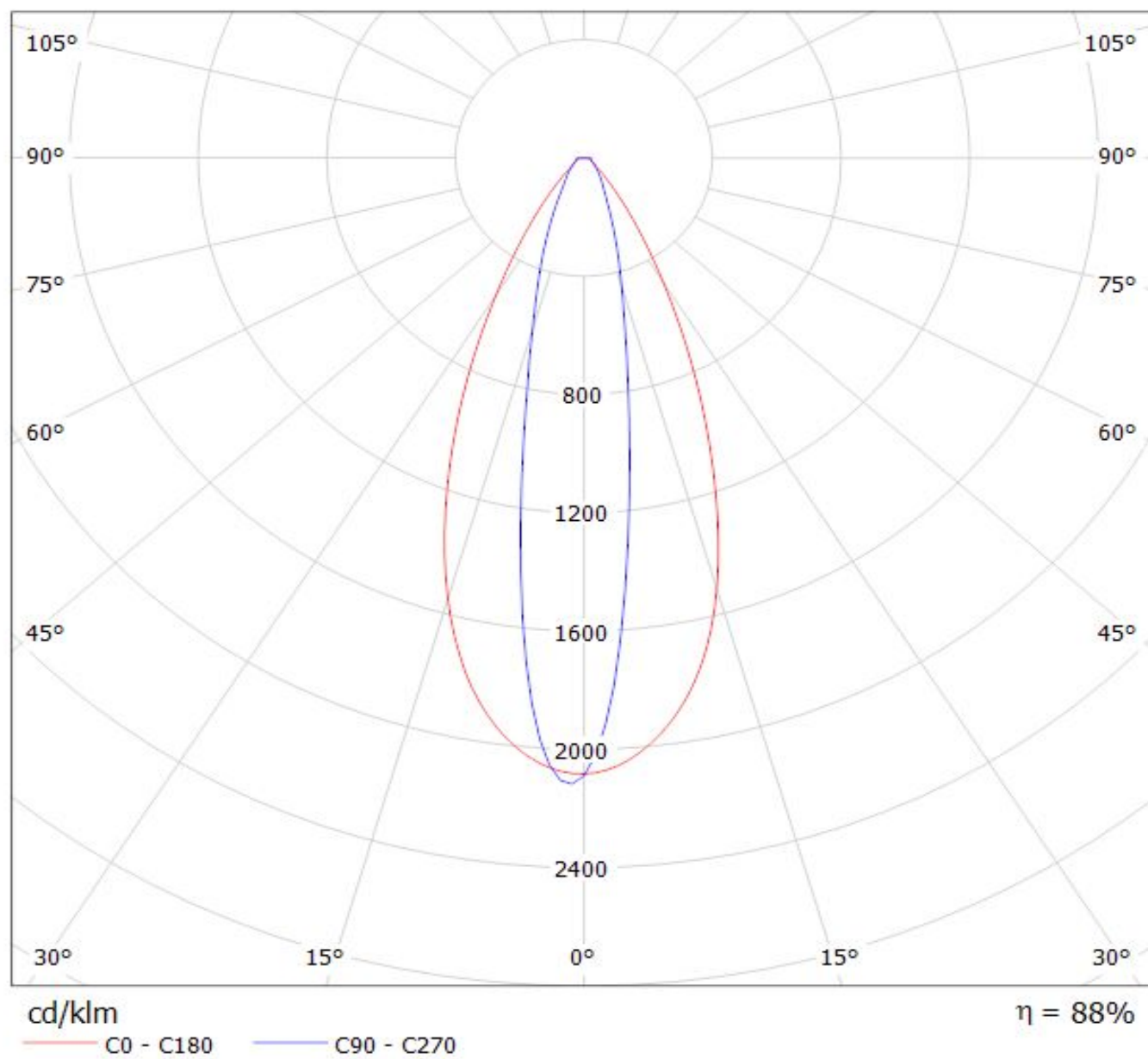

Luminaire: LEDiL Oy C13871_VANESSA-B-O_(REBEL-ES)

Lamps: 1 x REBEL-ES_12x1_811@250mA_P=9.07798W_I=249.8mA

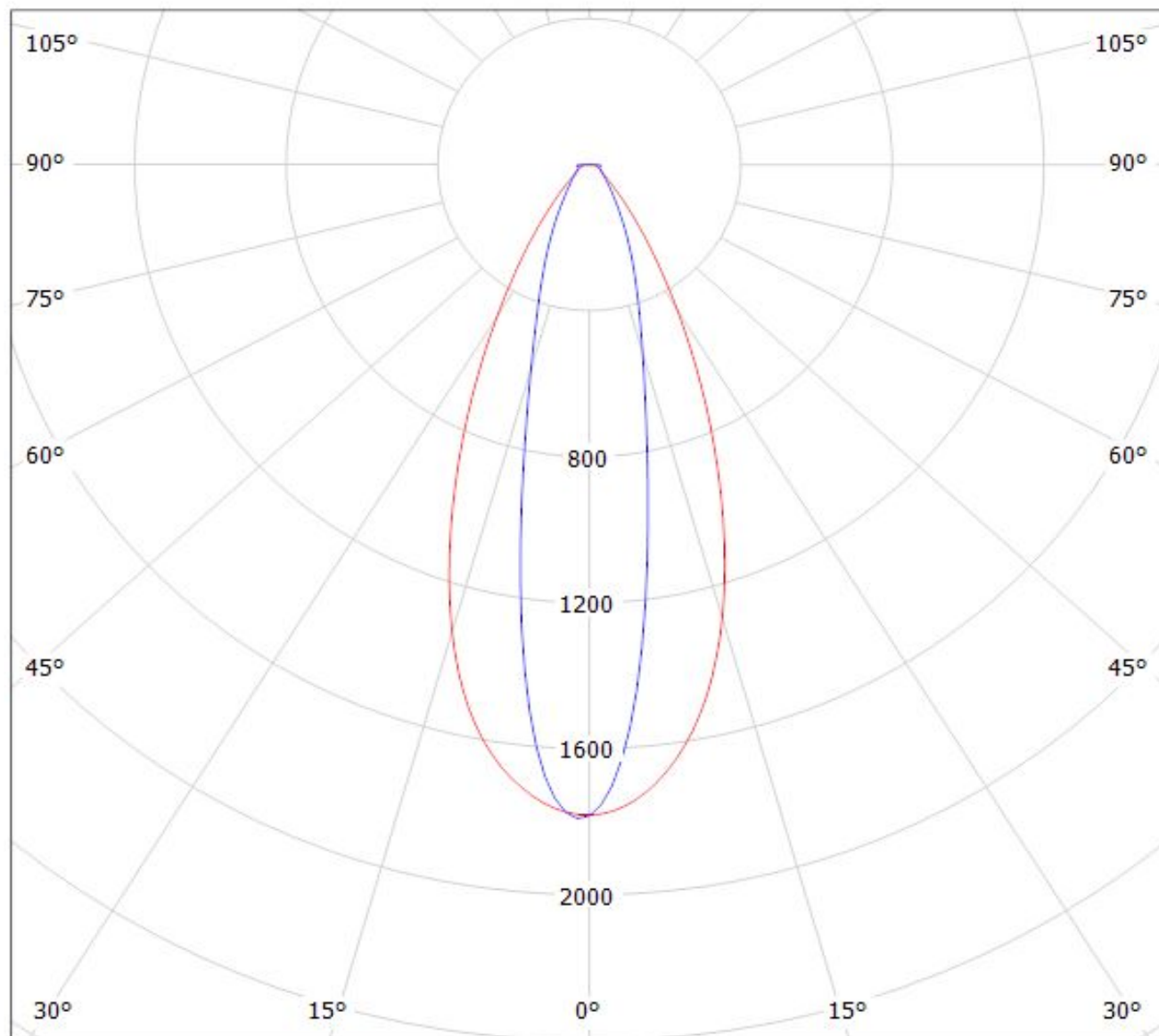

cd/klm

— C0 - C180

— C90 - C270

$\eta = 89\%$

Luminaire: LEDiL Oy C13871_VANESSA-B-O_(XP-G)

Lamps: 1 x CREE_XP-G_(XPGWHT-L1-4C0-R5-0-09)_1113.14lm@250mA_P=8.48621W_I=249.8mA

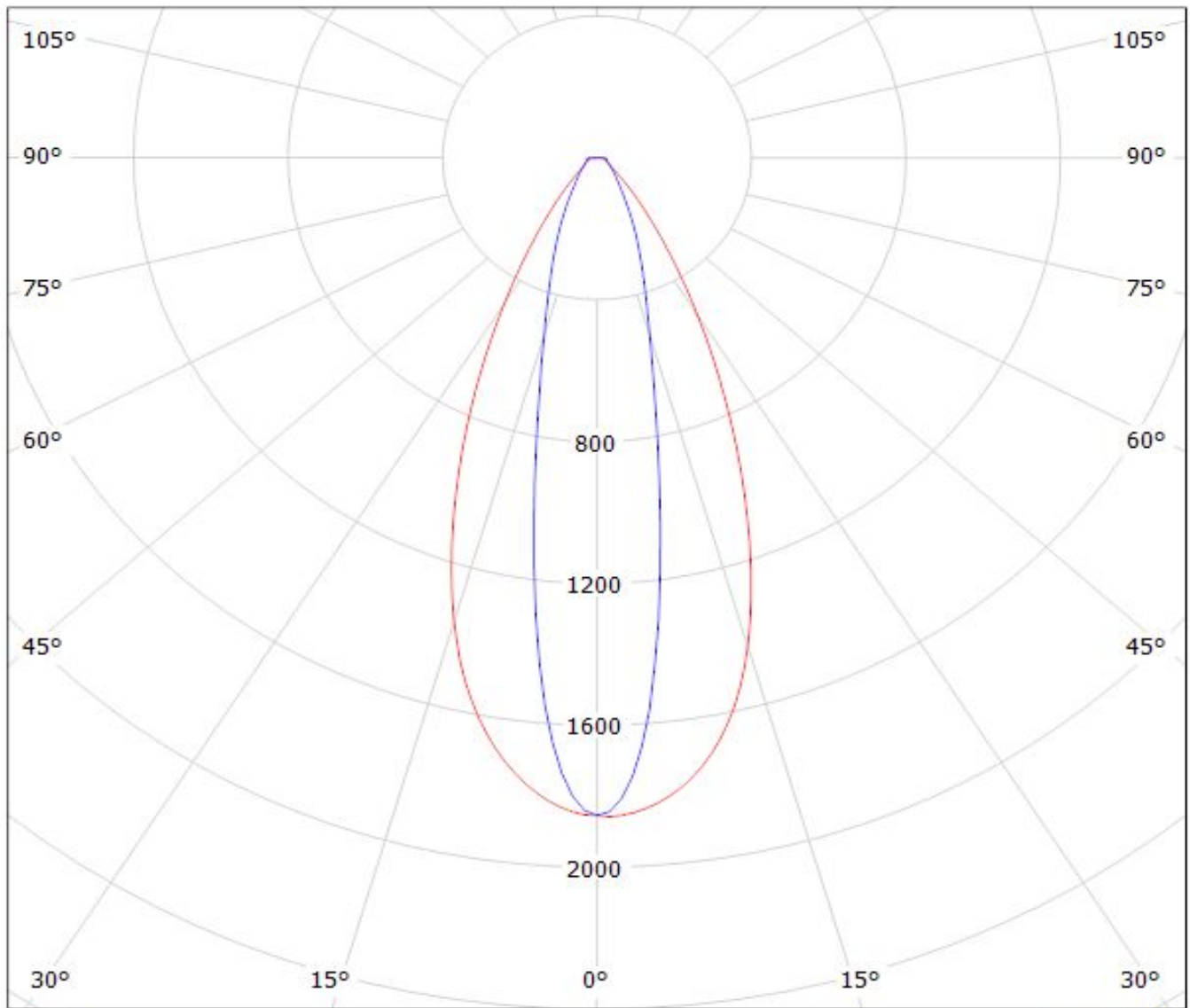

cd/klm

— C0 - C180

— C90 - C270

$\eta = 87\%$

Luminaire: LEDiL Oy C13871_VANESSA-B-O_(XP-G2)

Lamps: 1 x CREE_XP-G2_12x1_1174.06@250mA_P=8.65107_I=249.8mA

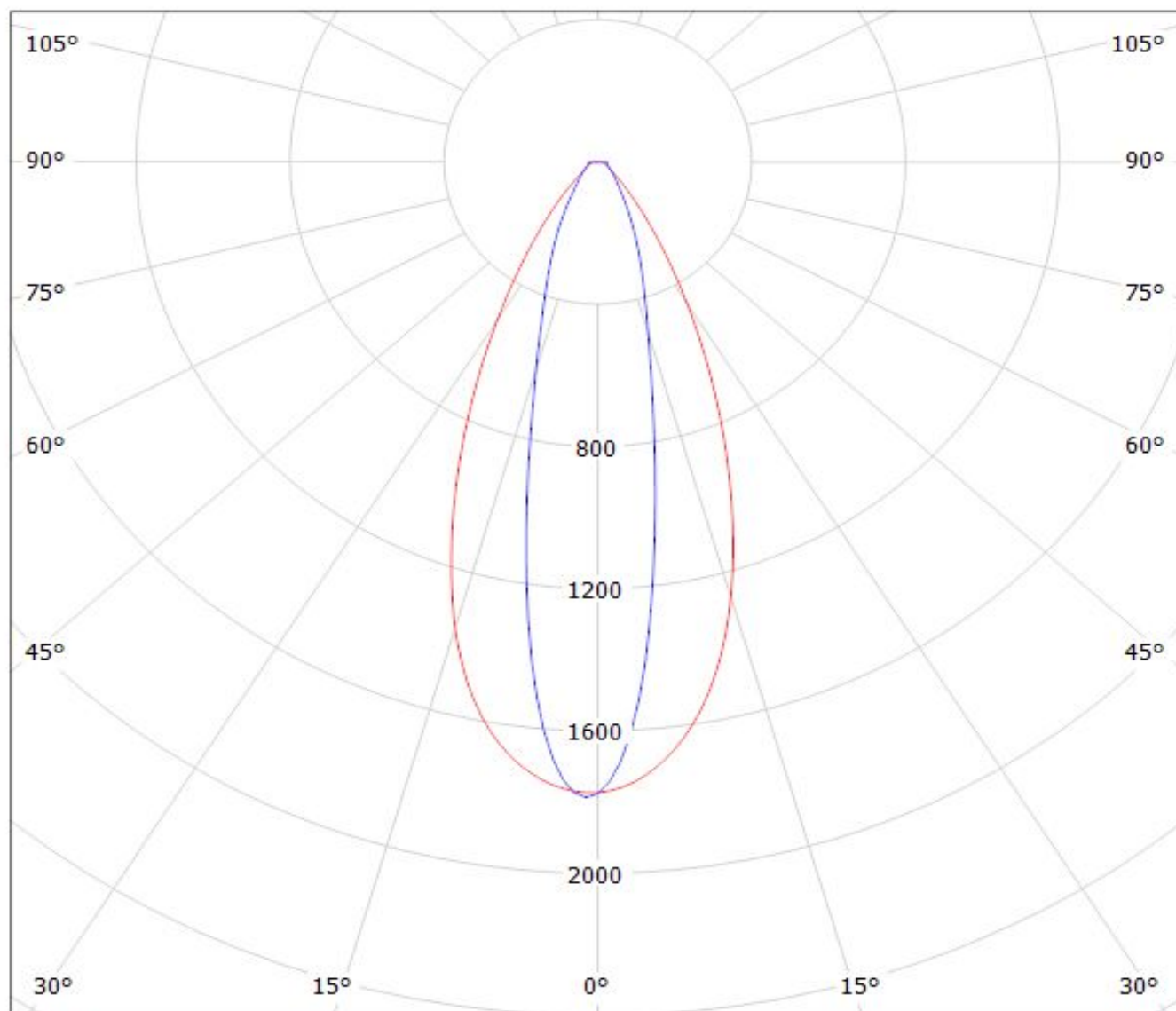

cd/klm

— C0 - C180

— C90 - C270

$\eta = 88\%$

NOTE: The typical divergence will be changed by different color, chip size and chip position tolerance. The typical total divergence is the full angle measured where the luminous intensity is half of the peak value.