

# Magnecraft® Solid State Relays

Catalog  
2010

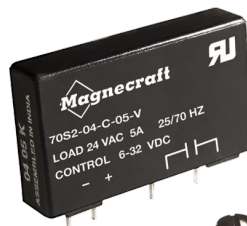
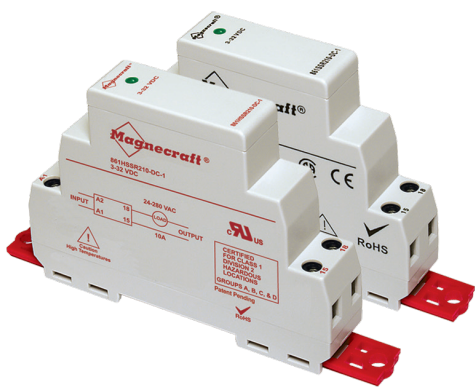

---

■ Series Overview . . . . .	3
■ 861 Relays . . . . .	4
■ 861H Relays . . . . .	7
■ SSRDIN Relays . . . . .	10
■ 6000 Series Relays . . . . .	13
■ Accessories for 6000 Series Relays . . . . .	17
■ 70S2 Series Relays . . . . .	19
■ Application Data . . . . .	24
■ Selection Guide . . . . .	30
■ Website Guide . . . . .	31

Depending on the application, the Magnecraft line of solid state relays offers a number of advantages over electromechanical relays, including longer life cycles, less energy consumption and reduced maintenance costs.

## Key Features

- 100% solid state design
- Modern appearance and advanced technology
- Industry first design (861 & 861H series)
- Several styles to fit multiple applications

Series	Defining Feature	Style	Internal Heat Sink	Contact Configuration	Output Current Range (A)	Input Voltage Range	Output Voltage Range	Page
<b>861</b>	Slim 17.5 mm profile	Slim DIN & panel mount	Yes	SPST-NO; SPST-NC	8–15	3–32 Vdc; 90–280 Vac	3–150 Vdc; 24–480 Vac	6
<b>861H</b>	Class 1, Division 2 certified for use in hazardous locations	Slim DIN & panel mount	Yes	SPST-NO; SPST-NC	8–15	3–32 Vdc; 90–280 Vac	3–150 Vdc; 24–480 Vac	9
<b>SSRDIN</b>	Integrated heat sink and high current switching capacity	DIN & panel mount	Yes	SPST-NO	10–45	4–32 Vdc; 90–280 Vac	0–60 Vdc; 24–660 Vac	12
<b>6000</b>	High current switching capacity in a small package	Hockey puck-panel mount	No	SPST-NO; DPST-NO	10–75	3–32 Vdc; 90–280 Vac	3–200 Vdc; 24–480 Vac	15
<b>70S2</b>	Small package size	PCB & panel mount	No	SPST-NO	3–25	3–32 Vdc	3–60 Vdc; 8–280 Vac	21



861 Relay



861H Relay



SSRDIN Relay



6000 Series Relays



70S2 Series Relays

## Description

# Magnecraft® Solid State Relays

861

SPST-NO, 8 A to 15 A

SPST-NC, 10 A

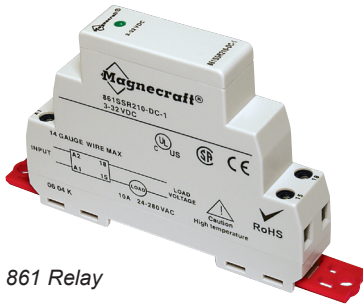

861 Relay

## Description

The 861 is the first complete solid state relay without any moving parts, all in a slim 17.5 mm design.

Feature	Benefit
Solid state circuitry	Involves no moving parts which extends product life, increases reliability, and enables silent operation
Optically coupled circuit	Provides isolation between input and output circuits
Internal snubber	Helps protect the relay's internal circuit from high voltage transients
Internal heat sink	Provides factory-tested thermal management
Fingersafe® terminals	Helps prevent an operator from touching live circuits
DIN and panel mounting	Mounts directly onto DIN rail or panel and provides flexibility to accommodate last minute design changes

Switching Type	Switching Device	Input Voltage Range	Output Voltage Range	Contact Configuration	Rated Output Current (A)	Standard Part Number
DC switching	MOSFET (1)	3.5–32 Vdc	3–50 Vdc	SPST-NO	15	861SSR115-DD
			3–150 Vdc	SPST-NO	8	861SSR208-DD
Random	SCR (2)	3–32 Vdc	24–280 Vac	SPST-NO	10	861SSR210-DC-2
			90–280 Vac	SPST-NC	10	861SSR210-DC-4
Zero cross	SCR	3–32 Vdc	24–280 Vac	SPST-NO	10	861SSR210-AC-2
			48–480 Vac	SPST-NO	10	861SSR410-DC-1
			24–280 Vac	SPST-NO	10	861SSR210-AC-1
			48–480 Vac	SPST-NO	10	861SSR410-AC-1

(1) MOSFET = metal oxide semiconductor field-effect transistor

(2) SCR = silicon-controlled rectifier

## Part Number Explanation

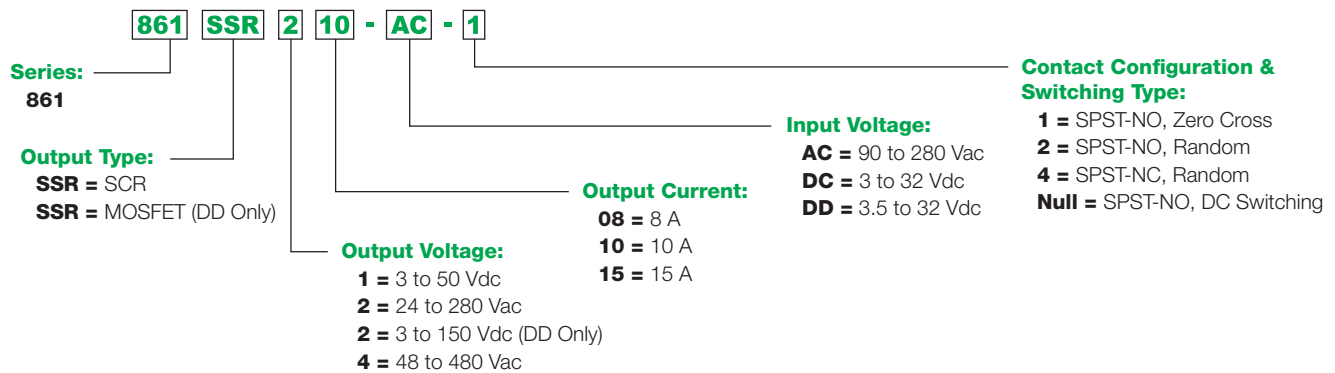

Specifications (UL 508)

Part Number	861SSR***-DD	861SSR***-DC-	861SSR***-AC-
<b>Input Characteristics</b>			
Input Voltage Range	3.5–32 Vdc	3–32 Vdc	90–280 Vac
Must Release Voltage	1 Vdc		10 Vac
Nominal Input Impedance	Current regulator		16–25 kΩ
Typical Input Current at 5 Vdc	12 mA	16 mA; 12 mA (861SSR210-DC-4)	12 mA
Reverse Polarity Protection	Yes	Yes	N/A
<b>Output Characteristics</b>			
Switching Device	MOSFET	SCR (2)	
Switching Type	DC switching	Zero cross; Random	
Contact Configuration	SPST-NO	SPST-NO; SPST-NC	
Output Voltage Range	3–150 Vdc	24–480 Vac	
Maximum Rate of Rise Off State Voltage (dv/dt)	N/A	500 V/us; 350 V/us (861SSR410); 200 V/us (861SSR210-DC-4)	
Output Current Range	8–15 A	10 A (rms)	
Minimum Load Current–Maintain On	20 mA	50 mA	
Non-Repetitive Surge Current (8.3 ms)	8 A: 35 A; 15 A: 50 A	500 A (rms)	
Maximum rms Overload Current (1 s)	8 A: 17 A; 15 A: 24 A;	24 A (rms)	
Maximum Off State Leakage Current	0.25 mA	10 mA (rms)	
Typical On State Voltage Drop	N/A	1.25 Vac (rms)	
Maximum On State Voltage Drop	0.5 Vdc	1.6 Vac (rms)	
Maximum On State Resistance	40 mΩ	N/A	
Maximum Turn-On Time	5 ms	8.3 ms	
Maximum Turn-Off Time	5 ms	8.3 ms	
Maximum I <sup>2</sup> T for Fusing	N/A	1250 A <sup>2</sup> sec (861SSR210); 850 A <sup>2</sup> sec (861SSR410)	
<b>General Characteristics</b>			
Electrical Life	N/A for solid state relays		
Thermal Resistance (Junction–Case)	8 A: 0.5 °C/W; 15 A: 1.4 °C/W	0.66 °C/W	
Internal Heat Sink	4.0 °C/W		
Dielectric Strength (Input–Output)	2500 V (rms)	4000 V (rms)	
Dielectric Strength (Terminals–Chassis)	2500 V (rms)		
Operating Temperature Range	–30 °C–+ 80 °C (derating applies)		
Storage Temperature Range	–40 °C–+100 °C		
Weight	127.1 g (4.1 oz)		
Input Indication	Green LED		
Terminal Wire Capacity (Input and Output)	14 AWG (2.5 mm <sup>2</sup> ) maximum		
Terminal Screw Torque	7.1 lb-in (0.8 N-m) maximum		
Safety Cover	IP20		
Agency Approvals	UL Listed (E258297); CE (per IEC60947-4-2); CSA (168986); RoHS		

*Dimensions,  
Wiring Diagram,  
De-Rating Curves*

# Magnecraft® Solid State Relays

861

SPST-NO, 8 A to 15 A

SPST-NC, 10 A

## Dimensions: Inches (Millimeters)

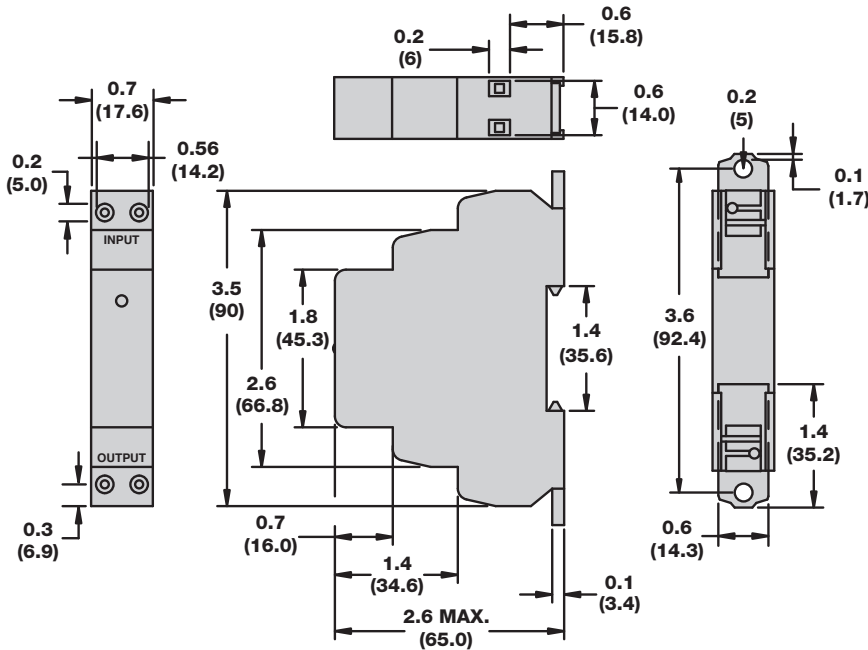

## Wiring Diagram

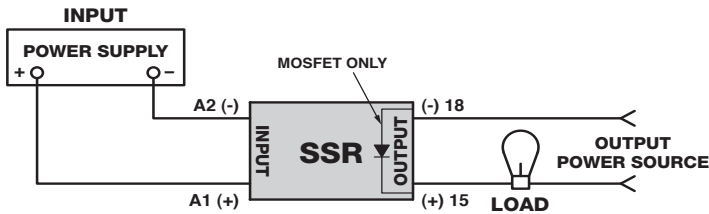

## De-Rating Curves

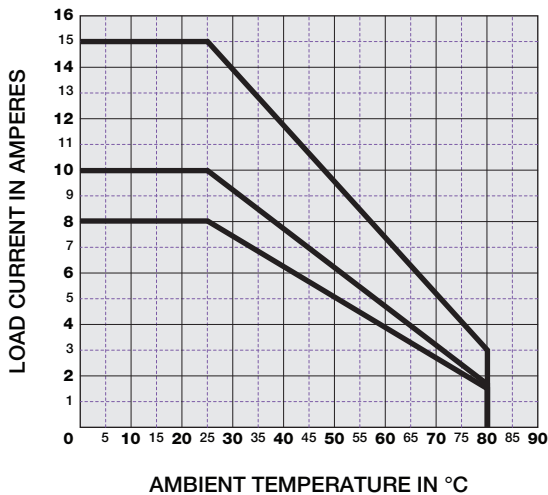

**Note:** A minimum spacing of 17.5 mm (0.7 in) between adjacent 861 relays is required in order to achieve the maximum ratings.

# Description

# Magnecraft® Solid State Relays

861H

SPST-NO, 8 A to 15 A



Class 1, Division 2 certification for use in hazardous locations. (Temperature code: T5)

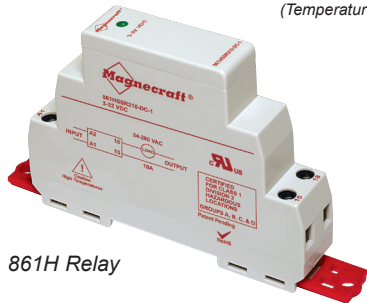

861H Relay

## Description

The 861H is the first complete solid state relay approved for use in hazardous locations. Patent pending.

Feature	Benefit
Class 1, Division 2 certification (1)	UL-approved relay for use in hazardous locations
Solid state circuitry	Involves no moving parts, which extends product life, increases reliability, and enables silent operation
Optically coupled circuit	Provides isolation between input and output circuits
Internal snubber	Helps protect the relay's internal circuit from high voltage transients
Internal heat sink	Provides factory-tested thermal management
Fingersafe® terminals	Helps prevent an operator from touching live circuits
DIN and panel mounting	Mounts directly onto DIN rail or panel and provides flexibility to accommodate last minute design changes

(1) See page 30 for more information on Class 1, Division 2.

Switching Type	Switching Device	Input Voltage Range	Output Voltage Range	Contact Configuration	Rated Output Current (A)	Standard Part Number
DC switching	MOSFET	3.5–32 Vdc	3–50 Vdc	SPST-NO	15	861HSSR115-DD
			3–150 Vdc	SPST-NO	8	861HSSR208-DD
Zero cross	SCR (2)	3–32 Vdc	24–280 Vac	SPST-NO	10	861HSSR210-DC-1
			48–480 Vac	SPST-NO	10	861HSSR410-DC-1
			48–600 Vac	SPST-NO	10	861HSSR610-DC-1
		90–280 Vac	24–280 Vac	SPST-NO	10	861HSSR210-AC-1
			48–480 Vac	SPST-NO	10	861HSSR410-AC-1
			48–600 Vac	SPST-NO	10	861HSSR610-AC-1

## Part Number Explanation

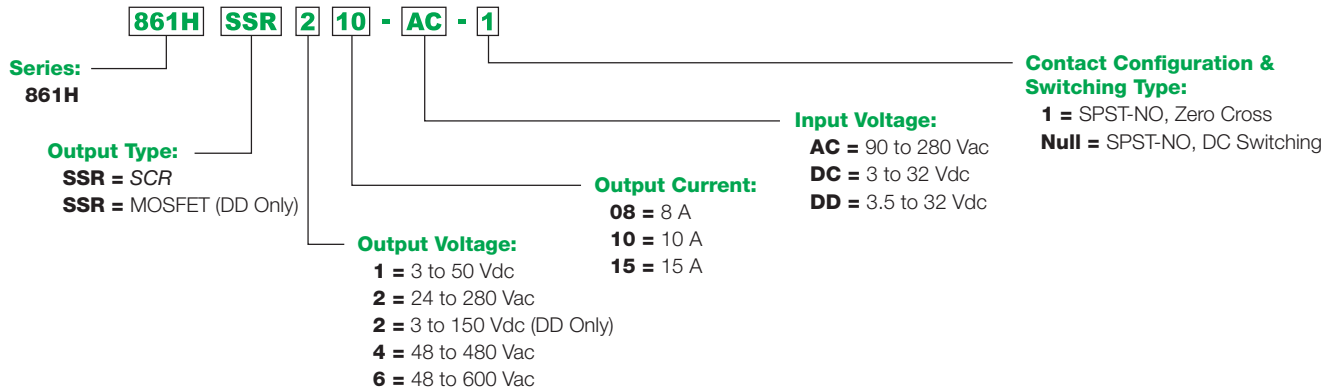

Specifications (UL 508)

Part Number	861SSR***-DD	861SSR***-DC-•	861SSR***-AC-•
<b>Input Characteristics</b>			
Input Voltage Range	3.5–32 Vdc	3–32 Vdc	90–280 Vac
Must Release Voltage	1 Vdc		10 Vac
Nominal Input Impedance	Current regulator		16–25 kΩ
Typical Input Current at 5 Vdc	12 mA	16 mA; 12 mA (861SSR210-DC-4)	12 mA
Reverse Polarity Protection	Yes	Yes	N/A
<b>Output Characteristics</b>			
Switching Device	MOSFET	SCR (2)	
Switching Type	DC switching	Zero cross; Random	
Contact Configuration	SPST-NO	SPST-NO; SPST-NC	
Output Voltage Range	3–150 Vdc	24–480 Vac	
Maximum Rate of Rise Off State Voltage (dv/dt)	8 A: 3–150 V; 15 A: 3–50 V	500 V/us; 350 V/us (861SSR410); 200 V/us (861SSR210-DC-4)	
Output Current Range	8–15 A	10 A (rms)	
Minimum Load Current–Maintain On	20 mA	50 mA	
Non-Repetitive Surge Current (8.3 ms)	8 A: 35 A; 15 A: 50 A	500 A (rms)	
Maximum rms Overload Current (1 s)	8 A: 17 A; 15 A: 24 A;	24 A (rms)	
Maximum Off State Leakage Current	0.25 mA	10 mA (rms)	
Typical On State Voltage Drop	N/A	1.25 Vac (rms)	
Maximum On State Voltage Drop	0.5 Vdc	1.6 Vac (rms)	
Maximum On State Resistance	40 mΩ	N/A	
Maximum Turn-On Time	5 ms	8.3 ms	
Maximum Turn-Off Time	5 ms	8.3 ms	
Maximum I <sup>2</sup> T for Fusing	N/A	1250 A <sup>2</sup> sec (861SSR210); 850 A <sup>2</sup> sec (861SSR410)	
<b>General Characteristics</b>			
Electrical Life	N/A for solid state relays		
Thermal Resistance (Junction–Case)	8 A: 0.5 °C/W; 15 A: 1.4 °C/W	0.66 °C/W	
Internal Heat Sink	4.0 °C/W		
Dielectric Strength (Input–Output)	2500 V (rms)	4000 V (rms)	
Dielectric Strength (Terminals–Chassis)	2500 V (rms)		
Operating Temperature Range	-30 °C–+ 80 °C (derating applies)		
Storage Temperature Range	-40 °C–+100 °C		
Weight	127.1 g (4.1 oz)		
Input Indication	Green LED		
Terminal Wire Capacity (Input and Output)	14 AWG (2.5 mm <sup>2</sup> ) maximum		
Terminal Screw Torque	7.1 lb-in (0.8 N·m) maximum		
Safety Cover	IP20		
Agency Approvals	Class 1, Division 2 (for hazardous locations); UL Recognized (E317746); RoHS		

## Dimensions: Inches (Millimeters)

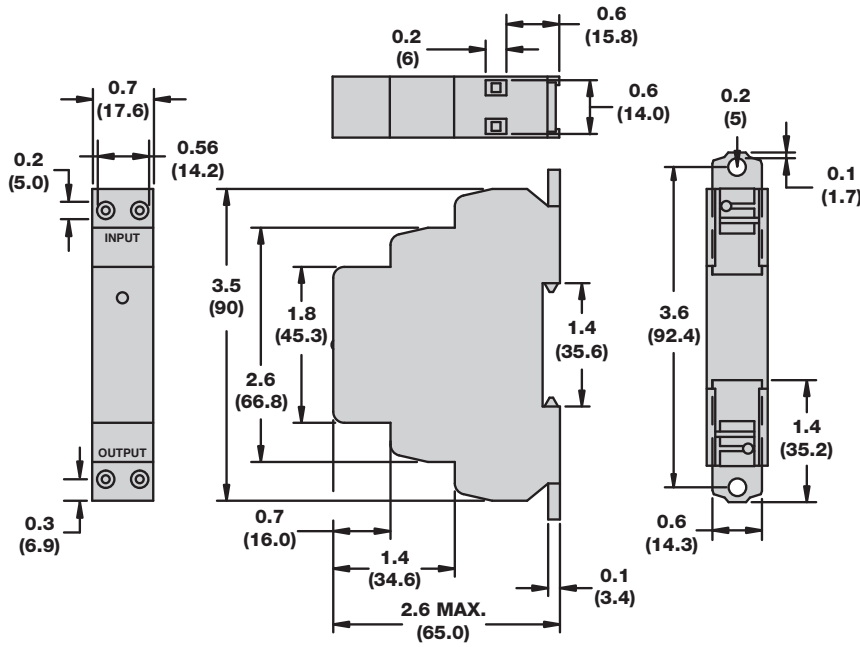

## Wiring Diagram

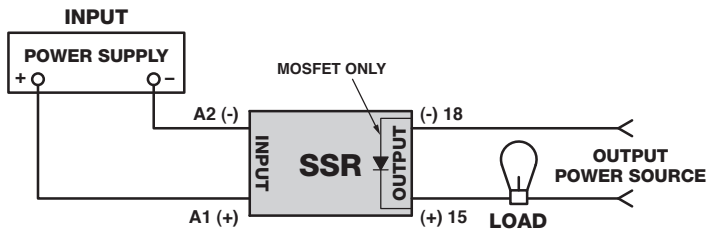

## De-Rating Curves

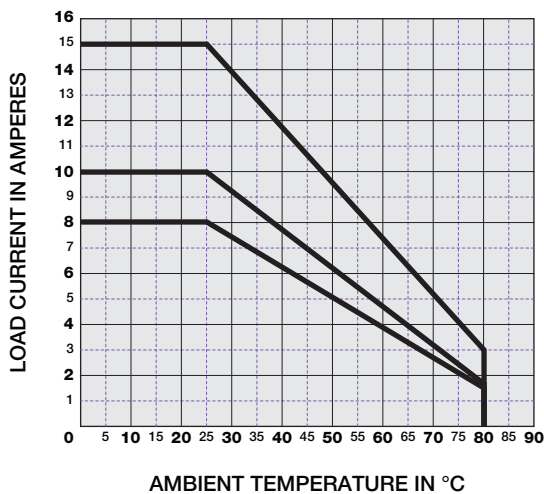

**Note:** A minimum spacing of 17.5 mm (0.7 in) between adjacent 861 relays is required in order to achieve the maximum ratings.

## Description

# Magnecraft® Solid State Relays

SSRDIN

SPST-NO, 10 A to 45 A



SSRDIN Relay

## Description

The SSRDIN relays offer a complete solid state package that is an energy-efficient, current switching alternative to standard electromechanical relays. Advantages include longer life cycles, less energy consumption, and reduced maintenance costs.

Feature	Benefit
Solid state circuitry	Involves no moving parts
Optically coupled circuit	Provides isolation between input and output circuits
Internal snubber	Helps protect the relay's internal circuit from high voltage transients
Internal heat sink	Provides factory tested thermal management
Integrated chassis ground	Simplifies system wiring
Fingersafe® terminals	Helps prevent an operator from touching live circuits
DIN and panel mounting	Increases functionality and ease of use and fits a variety of applications

Switching Type	Switching Device	Input Voltage Range	Output Voltage Range	Contact Configuration	Rated Output Current (A)	Standard Part Number
DC switching	MOSFET	4–32 Vdc	0–60 Vdc	SPST-NO	10	SSR310DIN-DC22 (1)
					20	SSR320DIN-DC22 (1)
					30	SSR330DIN-DC22 (1)
Zero cross	SCR	4–32 Vdc	24–280 Vac	SPST-NO	10	SSR210DIN-DC22
					20	SSR220DIN-DC22
					30	SSR230DIN-DC22
		3–32 Vdc	24–280 Vac	SPST-NO	45	SSR245DIN-DC45
					10	SSR610DIN-DC22
					20	SSR620DIN-DC22
		4–32 Vdc	48–660 Vac	SPST-NO	30	SSR630DIN-DC22
					45	SSR645DIN-DC45
					10	SSR210DIN-AC22
		90–280 Vac	24–280 Vac	SPST-NO	20	SSR220DIN-AC22
					30	SSR230DIN-AC22
					45	SSR245DIN-AC45
		90–140 Vac	24–280 Vac	SPST-NO	10	SSR610DIN-AC22
					20	SSR620DIN-AC22
					30	SSR630DIN-AC22
90–280 Vac	48–660 Vac	SPST-NO	45	SSR645DIN-AC45		
			10	SSR210DIN-AC22		
			20	SSR220DIN-AC22		
				SPST-NO	30	SSR630DIN-AC22
				SPST-NO	45	SSR645DIN-AC45

(1) No agency approvals on MOSFET versions

### Part Number Explanation

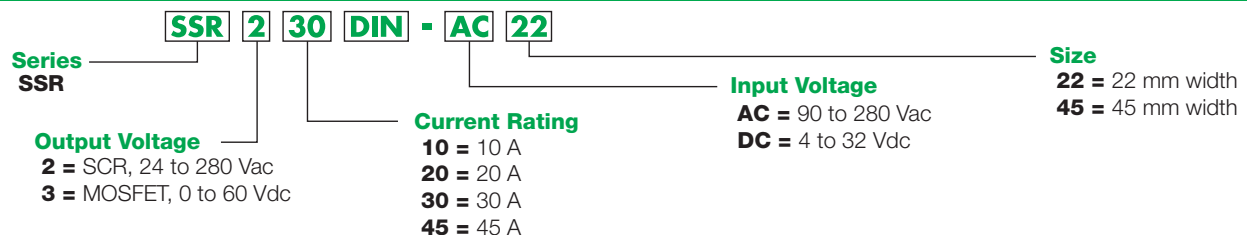

Specifications (UL 508)

Part Number	SSR2•DIN-DC••	SSR3•DIN-DC22	SSR6•DIN-DC••	SSR2•DIN-AC••	SSR6•DIN-AC••
<b>Input Characteristics</b>					
Input Voltage Range	4–32 Vdc			90–280 Vac	
Maximum Turn-On Voltage	4 Vdc			90 Vrms	
Minimum Turn-Off Voltage	1 Vdc			10 Vrms	
Typical Input Current	8–12 mA	9–11 mA	8–12 mA	2–4 mA	
<b>Output Characteristics</b>					
Output Type	SCR	MOSFET	SCR		
Switching Type	Zero voltage	DC switching	Zero voltage		
Output Voltage	24–280 Vac	0–60 Vdc	48–660 Vac	24–280 Vac	48–660 Vac
Load Current Range	10–45 A	10–30 A	10–45 A		
Transient Over-Voltage	600 Vpk	N/A	1200 Vpk	600 Vpk	1200 Vpk
Maximum Surge Current	10 A: 120 Apk; 20 A: 250 Apk; 30/45 A: 625 Apk (at 16.6 ms)	10 A: 30 Apk; 20 A: 60 Apk; 30 A: 90 Apk (at 10 ms)	625 Apk (at 16.6 ms)	10 A: 120 Apk; 20 A: 250 Apk; 30/45 A: 625 Apk (at 16.6 ms)	625 Apk (at 16.6 ms)
Maximum On-State Voltage Drop at Rated Current	1.6 Vpk	10 A: 0.2 Vpk; 20 A: 0.4 Vpk; 30 A: 0.5 Vpk	1.6 Vpk	1.6 Vpk	1.6 Vpk
Maximum I <sup>2</sup> t For Fusing, (8.3 ms)	10 A: 60 A <sup>2</sup> sec; 20 A: 260 A <sup>2</sup> sec; 30/45 A: 1620 A <sup>2</sup> sec	N/A	1620 A <sup>2</sup> sec	10 A: 60 A <sup>2</sup> sec; 20 A: 260 A <sup>2</sup> sec; 30/45 A: 1620 A <sup>2</sup> sec	1620 A <sup>2</sup> sec
Maximum Off-State Leakage Current at Rated Voltage	10 mA	0.1 mA	1 mA	10 mA	1 mA
Maximum Rate of Rise Off State Voltage (dv/dt)	500 V/us	N/A	500 V/us		
Maximum Response Time (On and Off)	1/2 cycle	1.0 ms	1/2 cycle		
Maximum On State Resistance	N/A	10 A: 20 mΩ; 20 A: 18 mΩ; 30 A: 16 mΩ	N/A		
<b>General Characteristics</b>					
Electrical Life	N/A for solid state relays				
Operating Temperature Range	-40–+80 °C (derating applies)				
Storage Temperature Range	-40–+125 °C				
Weight	10/20/30 A: 272 g (9.6 oz); 45 A: 482 g (17 oz)				
Input Indication	Green LED				
Encapsulation	Thermally conductive epoxy				
Input Terminal Screw Torque	10/20/30 A: 5.0-6.0 in lb (0.6-0.7 N·m); 45 A: 5.0-6.0 in lb (0.6-0.7 N·m)				
Output Terminal Screw Torque	10/20/30 A: 5.0-6.0 in lb (0.6-0.7 N·m); 45 A: 10.0-15.0 in lb (1.1-1.7 N·m)				
Mount Type	DIN rail and panel mount				
Agency Approvals	UL Recognized (E258297) SCR output only; CSA (168986) SCR output only; CE (per IEC 60950 and 61000); RoHS				

*Dimensions,  
Wiring Diagram,  
De-Rating Curves*

**Magnecraft® Solid State Relays**  
SSRDIN  
SPST-NO, 10 A to 45 A

**Dimensions: Inches (Millimeters)**

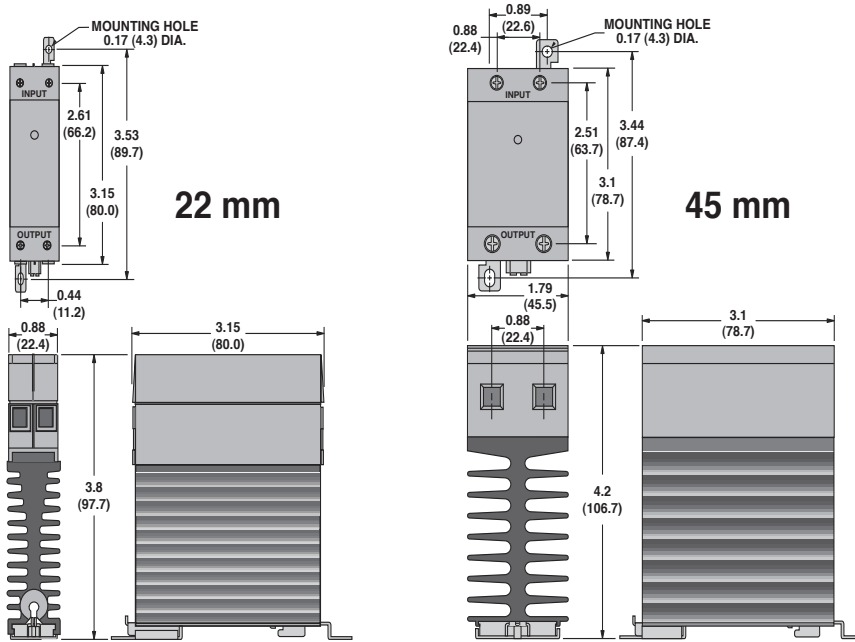

**Wiring Diagram**

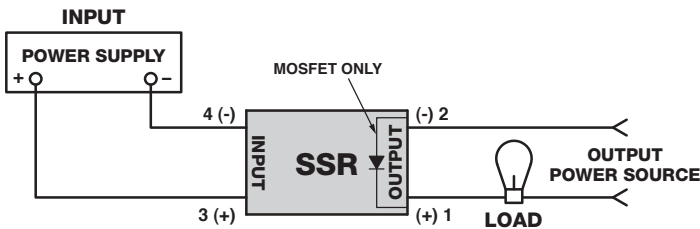

22 mm		45 mm	
input	output	input	output
a	6 mm <sup>2</sup> AWG 10	4 mm <sup>2</sup> AWG 12	10 mm <sup>2</sup> AWG 8

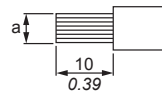

**De-Rating Curves**

Load Current vs Ambient Temperature (100% Duty Cycle)

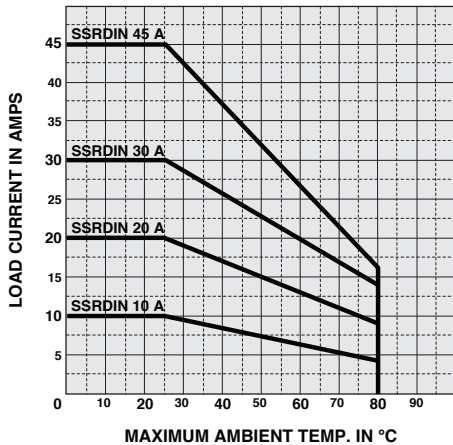

## Description

# Magnecraft® Solid State Relays

6000

SPST-NO, 10 A to 75 A

DPST-NO, 10 A to 25 A



6000 Series Relays

## Description

The 6000 Series solid state relays offer an energy-efficient, current switching alternative to standard electromechanical relays. Advantages include longer life cycles, less energy consumption, and reduced maintenance costs.

Feature	Benefit
Solid state circuitry	Involves no moving parts
Optically coupled circuit	Provides isolation between input and output circuits
Internal snubber	Helps protect the relay's internal circuit from high voltage transients
Fingersafe® terminals	Helps prevent an operator from touching live circuits

Switching Type	Switching Device	Input Voltage Range	Output Voltage Range	Contact Configuration	Rated Output Current (A)	Standard Part Number		
DC switching	MOSFET	3.5–32 Vdc	3–200 Vdc	SPST-NO	12	6312AXXMDS-DC3		
					25	6325AXXMDS-DC3		
					40	6340AXXMDS-DC3		
Zero cross	SCR	3–32 Vdc	24–280 Vac	SPST-NO	10	6210AXXSZS-DC3		
					25	6225AXXSZS-DC3		
					40	6240AXXSZS-DC3		
			48–480 Vac	SPST-NO	50	6250AXXSZS-DC3		
					25	6425AXXSZS-DC3		
					50	6450AXXSZS-DC3		
	90–280 Vac	SPST-NO	24–280 Vac	SPST-NO	10	6210AXXSZS-AC90		
					25	6225AXXSZS-AC90		
					40	6240AXXSZS-AC90		
			48–480 Vac	SPST-NO	SPST-NO	50	6250AXXSZS-AC90	
						75	6275AXXSZS-AC90	
						10	6410AXXSZS-AC90	
Triac	3–32 Vdc		24–280 Vac	DPST-NO	10	6210BXXTZB-DC3*		
					48–480 Vac	SPST-NO	25	6425AXXTZB-DC3*
							DPST-NO	25

\* Blade terminals.

## Part Number Explanation

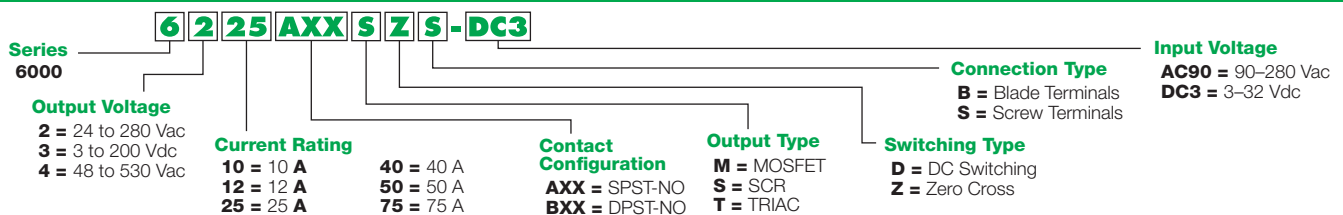

# Magnecraft® Solid State Relays

6000

SPST-NO, 10 A to 75 A

DPST-NO, 10 A to 25 A

## Specifications (UL 508)

Part Number	62**AXXSZS-AC90	64**AXXSZS-AC90	62**AXXSZS-DC3	64**AXXSZS-DC3
<b>Input Characteristics</b>				
Control Voltage Range	90–280 Vac (rms)		3–32 Vdc	4–32 Vdc
Maximum Turn-On Voltage	90 Vac (rms)		3 Vdc	4 Vdc
Minimum Turn-Off Voltage	10 Vac (rms)		1 Vdc	
Nominal Input Impedance	60 K $\Omega$		N/A	
Typical Input Current	2 mA at 120 V (rms), 4 mA at 240 V (rms)		10 mA at 12 Vdc	15 mA DC
<b>Output Characteristics</b>				
Switching Device	SCR			
Switching Type	Zero Cross			
Contact Configuration	SPST-NO			
Output Current Range	10–75 A	10–25 A	10–50 A	25–50 A
Output Voltage Range (47–63 Hz)	24–280 Vac (rms)	48–530 Vac (rms)	24–280 Vac (rms)	48–530 Vac (rms)
Transient Over-voltage	600 Vpk	1200 Vpk	600 Vpk	1200 Vpk
Maximum Off-State Leakage Current at Rated Voltage	10 mA (rms)		1 mA (rms)	
Minimum Off-State dv/dt at Maximum Rated Voltage	500 V/us			
Minimum Load Current	40 mA (rms)		150 mA (rms)	
Maximum Surge Current (16.6 ms)	10 A: 120 Apk; 25 A: 250 Apk; 40/50 A: 625 Apk; 75 A: 1000 Apk	10 A: 140 Apk; 25 A: 250 Apk	10 A: 120 Apk; 25 A: 250 Apk; 40/50 A: 625 Apk	25 A: 250 Apk; 50 A: 625 Apk
Maximum On-State Voltage Drop at Rated Current	1.6 V (rms)	1.7 V (rms)	1.6 V (rms)	
Maximum I <sup>2</sup> T for Fusing (8.3 ms)	10 A: 60 A <sup>2</sup> sec; 25 A: 260 A <sup>2</sup> sec; 40/50A: 1620 A <sup>2</sup> sec; 75A: 4150 A <sup>2</sup> sec	10 A: 81 A <sup>2</sup> sec; 25 A: 260 A <sup>2</sup> sec	10 A: 60 A <sup>2</sup> sec; 25 A: 260 A <sup>2</sup> sec; 40/50 A: 1620 A <sup>2</sup> sec	25 A: 260 A <sup>2</sup> sec; 50 A: 1620 A <sup>2</sup> sec
Minimum Power Factor (with Maximum Load)	0.5			
<b>General Characteristics</b>				
Electrical Life	N/A for solid state relays			
Maximum Turn-On Time	10 ms		1/2 Cycle	
Maximum Turn-Off Time	40 ms		1/2 Cycle	
Thermal Resistance (Junction–Case)	10 A: 1.48 °C/W; 25 A: 1.02 °C/W; 40/50A: 0.63 °C/W; 75 A: 0.31 °C/W			
Dielectric Strength, Input/Output/Base (50/60 Hz)	4000 Vac (rms)			
Minimum Insulation Resistance (at 500 Vdc)	1E+9 $\Omega$			
Maximum Capacitance (Input/Output)	8 pF			
Ambient Operating Temperature Range	–40–80 °C (derating applies)			
Ambient Storage Temperature Range	–40–125 °C			
Weight (typical)	86.5 g (3 oz)			
Input Indication	Green LED			
Encapsulation	Thermally conductive epoxy			
Terminals	Screw and saddle clamps furnished, unmounted			
Recommended Terminal Screw Torque Range	6-32 Screws: 10 lb-in; 8-32 & 10-32 Screws: 20 lb-in (Screws dry without grease)			
Safety Cover	Yes			
Wire Clamp Plates	Yes			
Agency Approvals	UL Recognized (E258297); CE (per IEC 60950 and 61000); CSA (168986); RoHS			

Specifications (UL 508)

Part Number	6***XXTZB-DC3	63**AXXMDS-DC3
<b>Input Characteristics</b>		
Control Voltage Range	3–32 Vdc	3.5–32 Vdc
Maximum Turn-On Voltage	3 Vdc	3.5 Vdc
Minimum Turn-Off Voltage	1 Vdc	
Nominal Input Impedance	Active current limiter	1k Ω
Typical Input Current	25 A: 16 mA; 10 A: 2 mA	10 mA
<b>Output Characteristics</b>		
Switching Device	Triac	MOSFET
Switching Type	Zero Cross	DC switching
Contact Configuration	SPST-NO, DPST-NO	SPST-NO
Output Current Range	10A–25A	12A–40A
Output Voltage Range	10 A: 24–280 Vac; 25 A: 48–480 Vac	3–200 Vdc
Transient Over-voltage	600 Vpk	200 Vpk
Maximum Off-State Leakage Current at Rated Voltage	10 mA	< 1 mA
Minimum Off-State dv/dt at Maximum Rated Voltage	250 V/us	N/A
Minimum Load Current–Maintain	80 mA	N/A
Maximum Surge Current (16.6 ms)	250 A	12 A: 27 A; 25 A: 50 A; 40 A: 90 A
Maximum On-State Voltage Drop at Rated Current	1.6 Vac (rms)	2.8 Vdc (at 40 A load)
Maximum I <sup>2</sup> T for Fusing (8.3 ms)	200 A <sup>2</sup> s	N/A
Minimum Power Factor (with Maximum Load)	0.5	0.95
<b>General Characteristics</b>		
Electrical Life	N/A for solid state relays	
Maximum Turn-On Time	1/2 cycle	300 us
Maximum Turn-Off Time	1/2 cycle	1 ms
Thermal Resistance (Junction–Case)	1.2 °C/W	1.06 °C/W
Dielectric Strength, Input/Output/Base (50/60 Hz)	4000 Vac (rms)	2500 Vac (rms)
Minimum Insulation Resistance (at 500 Vdc)	1E+9 Ω	
Maximum Capacitance (Input/Output)	10 pF	
Ambient Operating Temperature Range	-30–80 °C (derating applies)	-40–80 °C (derating applies)
Ambient Storage Temperature Range	-40–100 °C	
Weight (typical)	100 g (3.52 oz)	110 g (3.88 oz)
Input Indication	Green LED	
Encapsulation	Epoxy	
Terminals	1/4 in (6.35 mm); 3/16 in (4.74 mm)	Input: M3.5; Output: M4 (12 A), M6 (25/40 A)
Recommended Terminal Screw Torque Range	N/A	20 lb-in; 10 lb-in
Safety Cover	Yes (IP20)	
Wire Clamp Plates	N/A	Yes
Agency Approvals	UL Recognized (E258297), CSA (168986), CE (per IEC 60947-4-1), RoHS	

**Dimensions,  
Wiring Diagram,  
De-Rating Curves**

**Magnecraft® Solid State Relays**

6000

SPST-NO, 10 A to 75 A

DPST-NO, 10 A to 25 A

**Dimensions: Inches (Millimeters)**

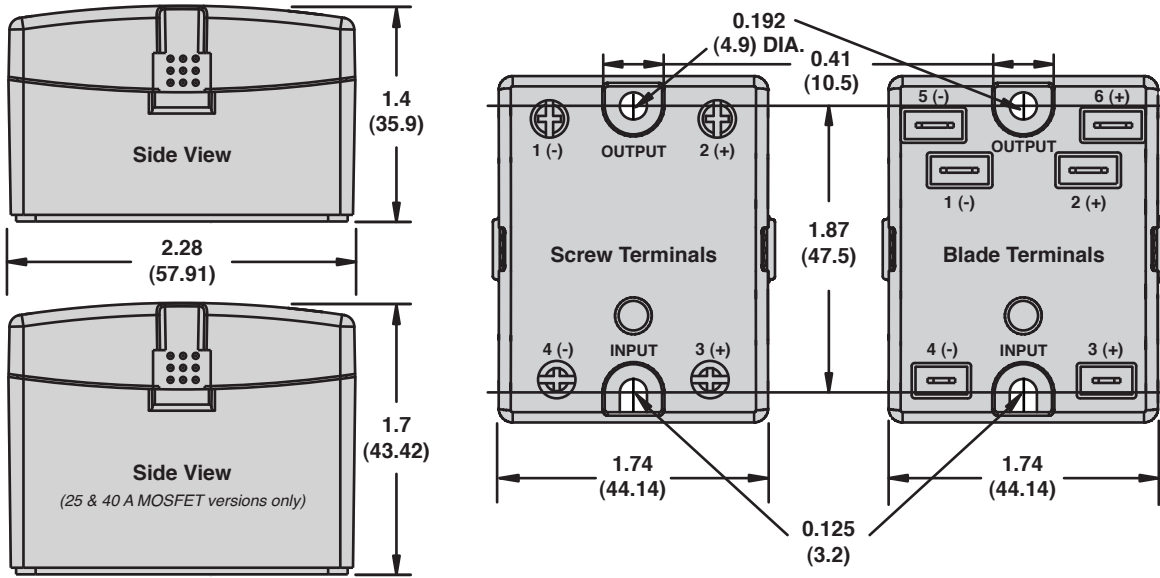

**Wiring Diagram**

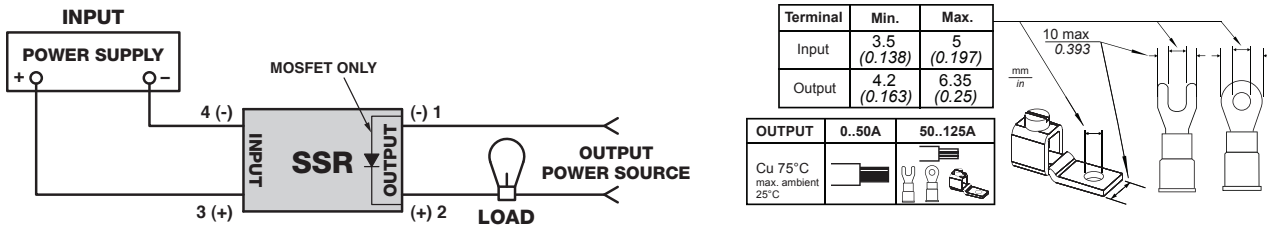

**De-Rating Curves**

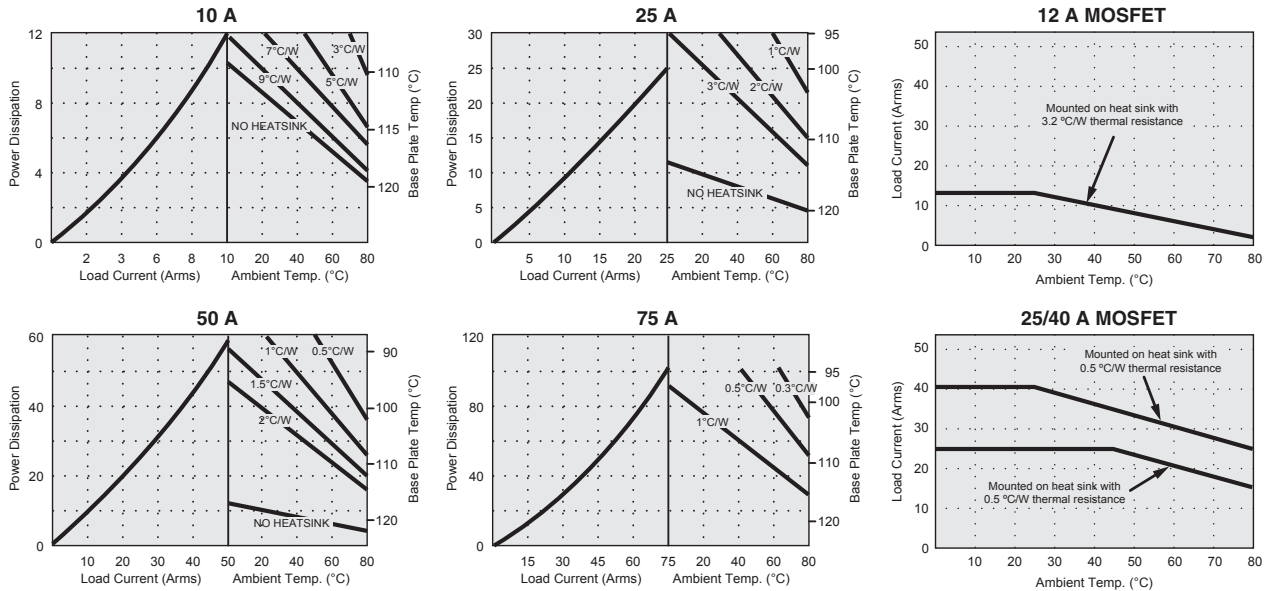

## Description

# Magnecraft® Solid State Relays

## Accessories for 6000 Series

### Heat Sink, SSR-HS-1

### Thermal Pad, SSR-TP-1



SSR-HS-1



SSR-TP-1

## Description

Thermal management is a fundamental consideration in the design and use of solid state relays (SSRs) because of the contact dissipation (typically 1 W per ampere). Therefore, it is vital that sufficient heat sinking is provided, or the life and switching reliability of the SSR will be compromised.

The SSR-HS-1 heat sink maximizes heat dissipation and helps ensure reliable operation when properly selected for the specific application. For ease of installation, all mounting holes are pre-drilled and tapped.

The SSR-TP-1 simplifies installation with a simple peel-and-stick solution, which does not require messy thermal grease.

## Relay Mounting Example

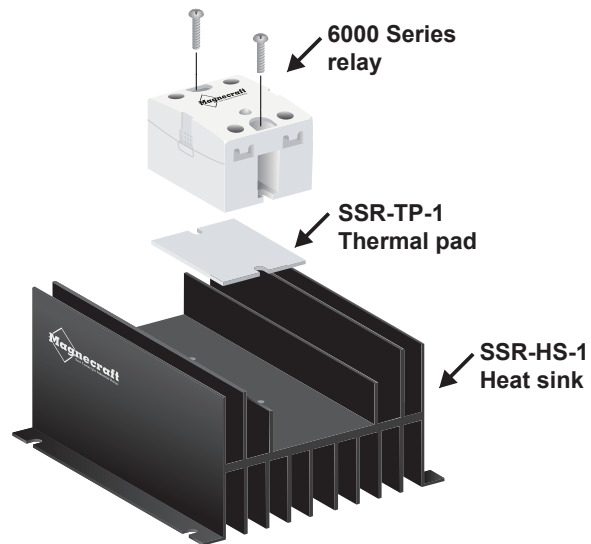

Description	Function	Weight	For Use With Relays	Packaging Minimum	Standard Part Number
Heat sink	Maximizes heat dissipation	558.5 g (19.7 oz)	6000 Series Relays (rated up to 50 A)	1	SSR-HS-1
Thermal pad	Simplifies installation with a simple peel-and-stick solution, which does not require messy thermal grease	N/A	6000 Series Relays (rated up to 50 A)	10	SSR-TP-1

Dimensions: Inches (Millimeters)

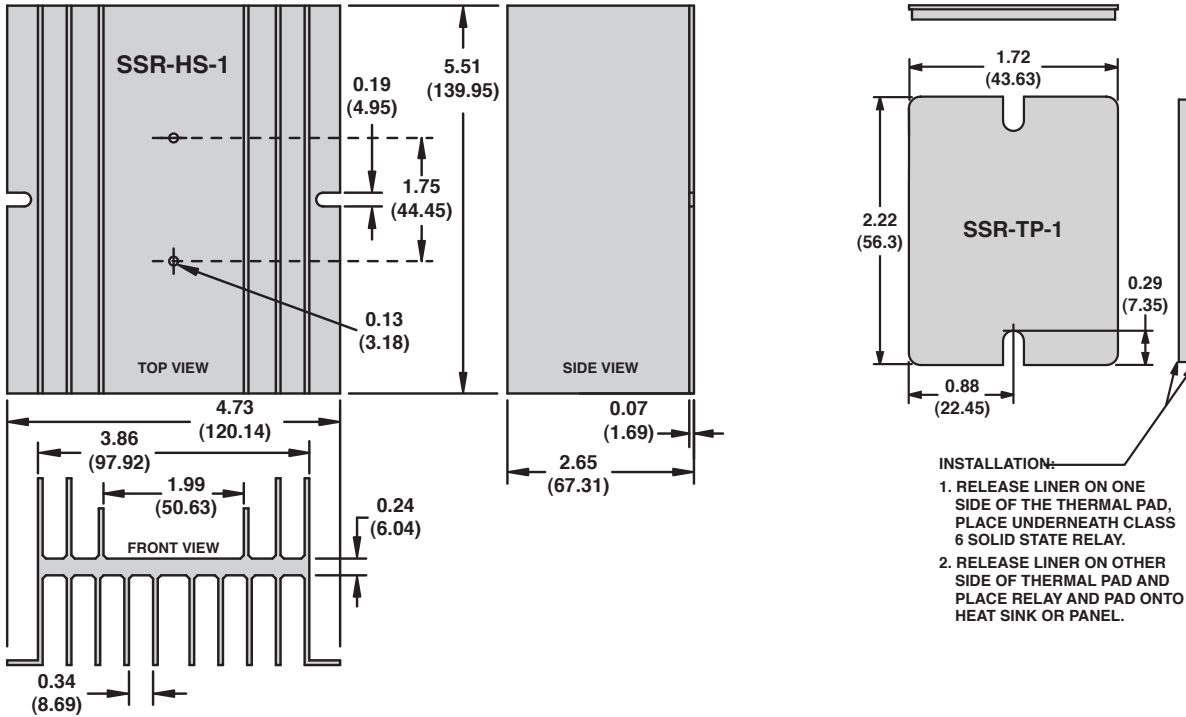

De-Rating Curves (when used with thermal pad and heat sink)

Thermal Resistance vs Power Dissipation

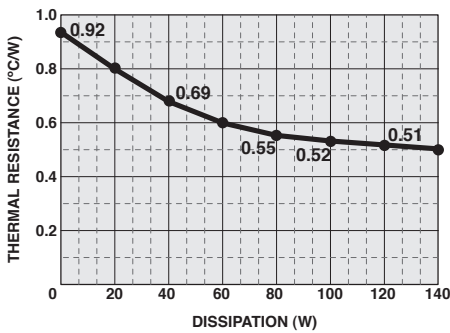

Load Current vs Ambient Temperature (100% Duty Cycle)

50A 6000 Series Relay with (70 Cfm) Fan

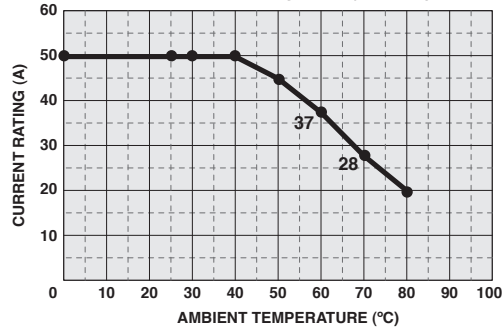

50A 6000 Series Relay without Fan

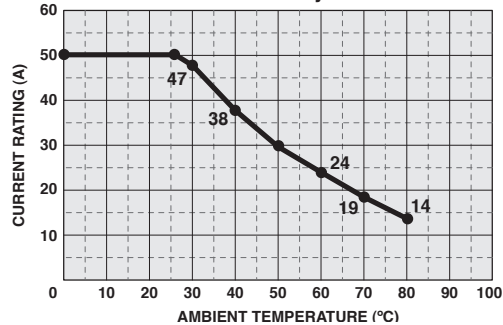

## Description

# Magnecraft® Solid State Relays

70S2

SPST-NO, 3 A to 25 A

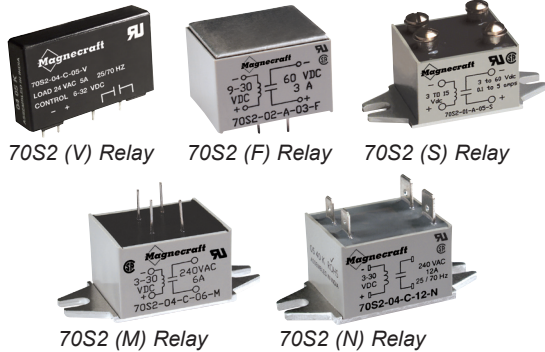

## Description

The 70S2 Series are miniature solid state relays ideal for small space applications. They are available in panel and PCB mount, which increases the level of flexibility for designers.

Feature	Benefit
Solid state circuitry	Involves no moving parts
Optically coupled circuit	Provides isolation between input and output circuits
Internal snubber	Helps protect the relay's internal circuit from high voltage transients
Small package size	Ideal for small spaces
Panel and PCB mounting	Increases functionality and ease of use

Switching Type	Switching Device	Input Voltage Range	Output Voltage Range	Rated Output Current (A)	Terminal Style	Mounting Style	Standard Part Number
DC switching	MOSFET	3–15 Vdc	3–60 Vdc	3	Solder	PCB Mount	70S2-01-A-03-V
				5	Blade	Panel Mount	70S2-01-A-05-N
		9–30 Vdc	3–60 Vdc	5	Screw	Panel Mount	70S2-01-A-05-S
				5	Screw	Panel Mount	70S2-02-A-05-S
Zero cross	Triac	3–30 Vdc	24–140 Vac	4	Solder	PCB Mount	70S2-04-B-04-F
				6	Blade	Panel Mount	70S2-04-B-06-N
				6	Screw	Panel Mount	70S2-04-B-06-S
				6	Blade	Panel Mount	70S2-04-B-12-N
				12	Screw	Panel Mount	70S2-04-B-12-S
				25	Screw	Panel Mount	70S2-03-B-25-S
				6	Blade	Panel Mount	70S2-04-C-06-N
		6	Screw	Panel Mount	70S2-04-C-06-S		
		10	Solder	PCB/Panel Mount	70S2-04-C-10-M		
		12	Blade	Panel Mount	70S2-04-C-12-N		
		12	Screw	Panel Mount	70S2-04-C-12-S		
		12	Screw	Panel Mount	70S2-06-C-12-S		
		25	Screw	Panel Mount	70S2-03-C-25-S		
		3–32 Vdc	24–140 Vac	3	Solder	PCB Mount	70S2-04-B-03-V
3–32 Vdc	24–280 Vac	3	Solder	PCB Mount	70S2-04-C-03-V		
3–32 Vdc	8–50 Vac	3	Solder	PCB Mount	70S2-04-D-03-V		
6–30 Vdc	24–280 Vac	12	Screw	Panel Mount	70S2-05-C-12-S		

### Part Number Explanation

**70S2 - 01 - A - 03 - V**

Series:  
70S2

#### Input Voltage:

- 01 = 3 to 15 Vdc
- 02 = 9 to 30 Vdc
- 03 = 3 to 30 Vdc
- 04 = 3 to 30 Vdc
- 05 = 6 to 30 Vdc
- 06 = 6 to 30 Vdc

#### Output Voltage:

- A = 3 to 60 Vdc
- B = 24 to 140 Vac
- C = 24 to 280 Vac
- D = 8 to 50 Vac

#### Output Current:

- 03 = 3 A
- 04 = 4 A
- 05 = 5 A
- 06 = 6 A
- 10 = 10 A
- 12 = 12 A
- 25 = 25 A

#### Package Type:

- F = PCB Mount w/Solder Terminals
- M = PCB/Panel Mount w/Solder Terminals
- N = Panel Mount w/Blade Terminals
- S = Panel Mount w/Screw Terminals
- V = PCB Mount w/Solder Terminals

Specifications (UL 508)

Part Number	70S2-01-A	70S2-02-A	70S2-03-B	70S2-03-C
<b>Input Characteristics</b>				
Control Voltage Range	3–15 Vdc	9–30 Vdc	3–30 Vdc	
Must Release Voltage	1 Vdc			
Typical Input Current	5–40 mA	5–17 mA	7–16 mA	6–10 mA
Maximum Reverse Control Voltage	3 Vdc			
<b>Output Characteristics</b>				
Switching Device	MOSFET		Triac	
Switching Type	DC Switching		Zero Cross	
Contact Configuration	SPST-NO			
Output Voltage Range	3–60 Vdc		24–140 Vac	24–280 Vac
Peak Blocking Voltage	105 Vdc		400 Vac	600 Vac
Maximum Rate of Rise Off State Voltage (dv/dt)	N/A		300 V/us	
Output Current Range (rms)	3–5 A	5 A	25 A	25 A
Minimum Load Current–Maintain On	N/A		100 mA	
Non-Repetitive Surge Current (8.3 ms)	3 A: 5 A (1 s); 5 A: 7 A (1 s)		300 A	
Maximum Off State Leakage Current (rms)	10 mA		6 mA	
Typical On State Voltage Drop (rms)	3 A: 1.2 Vdc; 5 A: 1.85 Vdc		1.7 Vac	
Maximum Turn-On Time	75 ms		8.3 ms	
Maximum Turn-Off Time	3 A: 500 ms; 5 A: 75 ms		8.3 ms	
<b>General Characteristics</b>				
Electrical Life	N/A for solid state relays			
Thermal Resistance (Junction–Case)	3 A: 0.5 °C/W; 5/25 A: 4 °C/W			
Dielectric Strength (Input–Output)	3 A: 4000 Vac; 5 A: 2500 Vac		3000 Vac	
Dielectric Strength (Terminals–Chassis)	3 A: 4000 Vac; 5 A: 2500 Vac		3000 Vac	
Operating Temperature Range	–40–+100 °C			
Storage Temperature Range	–40–+125 °C			
Weight	F/M: 35 g (1.2 oz); N/S: 47 g (1.7 oz); V: 25 g (0.9oz)			
Agency Approvals	UL Recognized (E258297); CSA (040787); RoHS			

Specifications (UL 508)

Part Number	70S2-04-B	70S2-04-C	70S2-04-D	70S2-05-C	70S2-06-C
<b>Input Characteristics</b>					
Control Voltage Range	3 A: 3–32 Vdc; 4/6/10/12 A: 3–30 Vdc			6–30 Vdc	3–30 Vdc
Must Release Voltage	1 Vdc				
Typical Input Current	3 A: 1–19 mA; 4/6/10/12 A: 7–16 mA			6–10 mA	1–17 mA
Maximum Reverse Control Voltage	3 Vdc				
<b>Output Characteristics</b>					
Switching Device	Triac				
Switching Type	Zero Cross				
Contact Configuration	SPST-NO				
Output Voltage Range	24–140 Vac	24–280 Vac	8–50 Vac	24–280 Vac	
Peak Blocking Voltage	400 Vac	600 Vac	200 Vac	600 Vac	
Maximum Rate of Rise Off State Voltage (dv/dt)	300 V/us				
Output Current Range (rms)	3–12 A	3–12 A	3 A	12 A	
Minimum Load Current–Maintain On	3/4/6 A: 75 mA; 10/12 A: 100 mA				
Non-Repetitive Surge Current (8.3 ms)	3/4/6 A: 60 A; 10/12 A: 150 A				
Maximum Off State Leakage Current (rms)	6 mA		10 mA	6 mA	
Typical On State Voltage Drop (rms)	1.6 Vac				
Maximum Turn-On Time	8.3 ms				
Maximum Turn-Off Time	8.3 ms				
<b>General Characteristics</b>					
Electrical Life	N/A for solid state relays				
Thermal Resistance (Junction–Case)	3 A: 0.5 °C/W ; 4/6/10/12 A: 4 °C/W				2.4 °C/W
Dielectric Strength (Input–Output)	3 A: 4000 Vac; 4/6/10/12 A: 3000 Vac				
Dielectric Strength (Terminals–Chassis)	3 A: 4000 Vac; 4/6/10/12 A: 3000 Vac				
Operating Temperature Range	-40–+100 °C (derating applies)				
Storage Temperature Range	-40–+125 °C				
Weight	F/M: 35 g (1.2 oz); N/S: 47 g (1.7 oz); V: 25 g (0.9 oz);				
Agency Approvals	UL Recognized (E258297); CSA (040787); RoHS				

Dimensions: inches (millimeters)

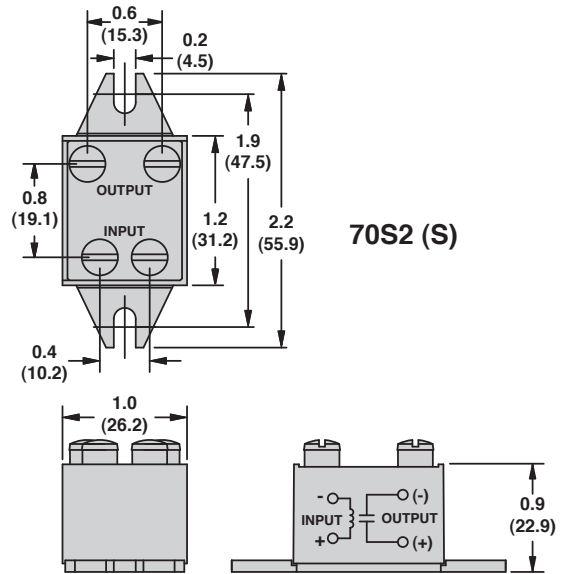
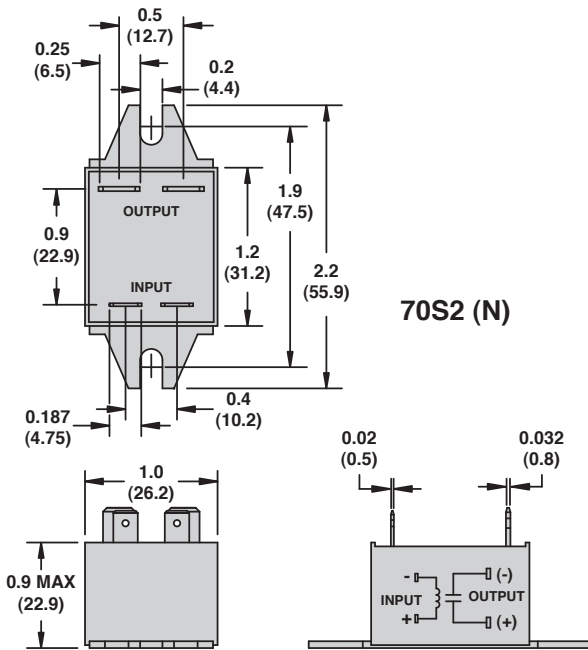
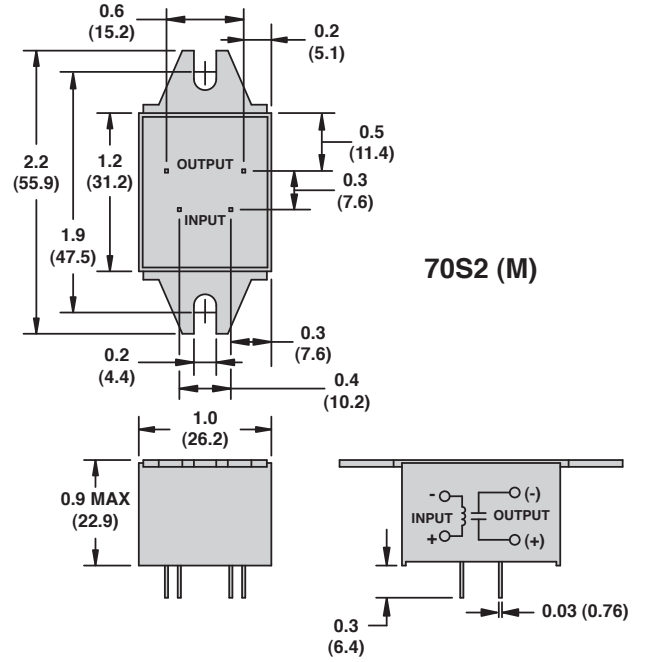
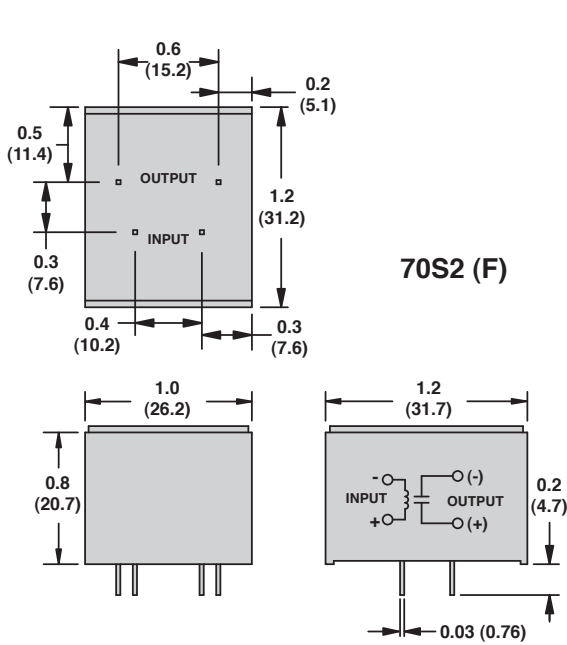

Dimensions: inches (millimeters)

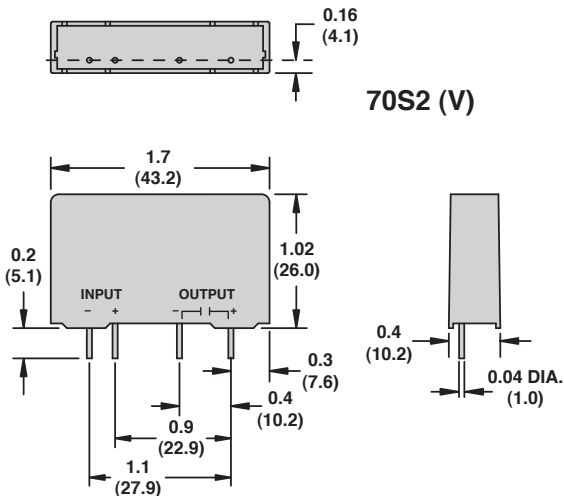

Wiring Diagram

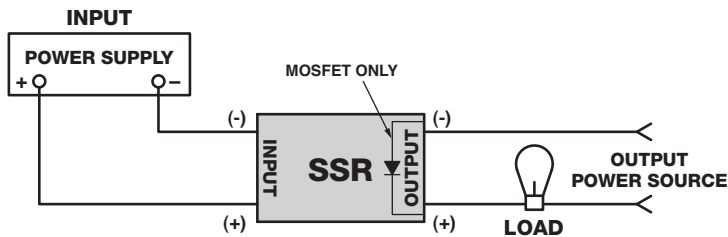

De-Rating Curves

Load Current vs Ambient Temperature (100% Duty Cycle)

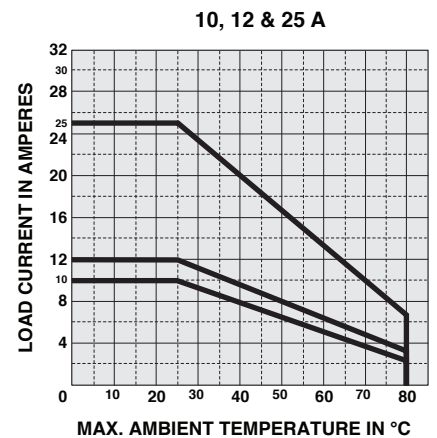
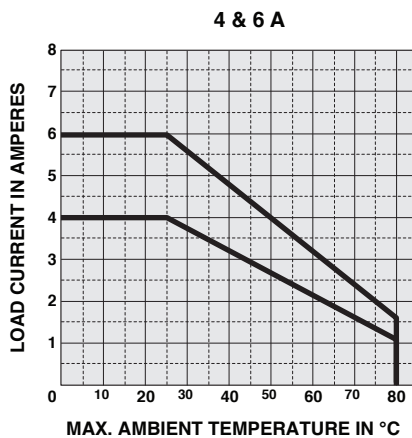
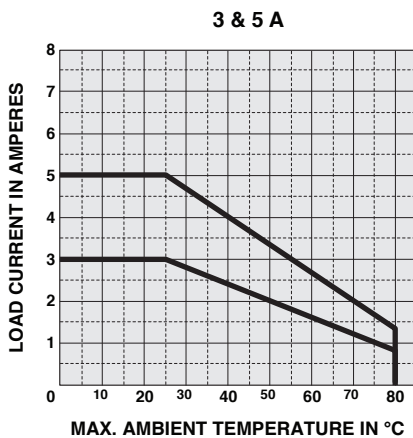

## Definition

A solid state relay (SSR) can perform many tasks that an electromechanical relay (EMR) can perform. The SSR differs in that it has no moving mechanical parts. It is essentially an electronic device that relies on the electrical and optical properties of semiconductors to achieve its isolation and switching function.

## Principle of Operation

SSRs are similar to electromechanical relays, in that both use a control circuit and a separate circuit for switching the load. When voltage is applied to the input of the SSR, the relay is energized by a light emitting diode. The light from the diode is beamed into a light sensitive semiconductor which conditions the control circuit to turn on the output solid state switch. In the case of zero voltage crossover relays, the output solid state switch is turned on at the zero crossing of AC voltage. Removal of the input power disables the control circuit and the solid state switch also turns off when the load current passes through the zero point of its cycle. Zero cross is only applied to AC switching circuits. DC switching circuits operate at an instant on/off rate.

## Advantages

When used correctly in the intended application, the SSR provides many of the characteristics that are often difficult to find in the EMR: a high degree of reliability, long service life, significantly reduced electromagnetic interference, fast response and high vibration resistance are significant benefits of the SSR. The SSR has no moving parts to wear out or arcing contacts to deteriorate, which are often the primary cause of failure with an EMR.

- Long life (reliability) > 1E+9 operations
- Arc-less switching
- Zero voltage turn on, low EMI/RFI
- No acoustical noise
- Shock and vibration resistant
- TTL compatible
- Random turn-on, proportional control
- Fast response
- No contact bounce
- No moving parts

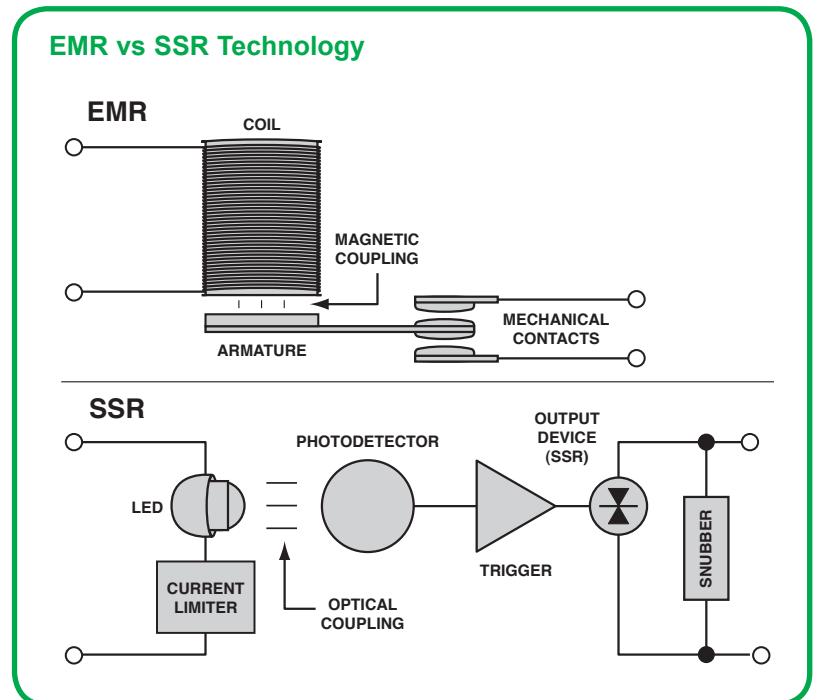

## Applications

Since its introduction, SSR technology has gained acceptance in many applications that had previously been the sole domain of the EMR or contactor. The major growth areas have come from industrial process control applications; particularly heat/cool temperature control, motors, lamps, solenoids, valves, and transformers. The list of applications for the SSR is almost limitless.

### Typical Examples of SSR Applications



#### Electronic Appliances

Domestic appliances, cooking appliances, heating elements, audio equipment



#### Industrial Heater Control

Plastics industry: drying, extrusion/thermoforming, heat tracing, solder wave/reflow systems, car wash pumps and dryers



#### Food & Beverage

Commercial/industrial cooking equipment, filtration systems, bottling, chillers, convection ovens



#### Lighting Control

Traffic signal systems, motorway information systems, theatrical lighting



#### High Reliability

Medical equipment, lifts & escalators, low switching noise, low electromagnetic interference, automatic door operation



#### Mining

Blower control, motorized duct/vent control, drill control, explosive control, mineral extractors



#### HVAC & Refrigeration

Anti-condensation equipment, compressor control, blower control, motorized duct/vent control

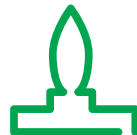

#### Oil & Gas

Burner assemblies, chemical injection systems, extraction machines, refining machines, solenoid control



#### Industrial Appliances

Industrial cleaning equipment, commercial coffee machines, commercial/industrial cooking equipment



#### Packaging

Conveyor motors, heaters, product/shrink wrap, solenoid control



#### Industrial Automation

Automotive assembly plants, conveyance, motor control

## Thermal Considerations

One of the major considerations when using a SSR is properly managing the heat that is generated when switching currents are higher than 5 A. In this scenario mount the base plate of the SSR on a good heat conductor, such as aluminum, and use a good thermal transfer medium, such as thermal grease or a heat transfer pad. Using this technique, the SSR case to heat sink thermal resistance is reduced to a negligible value of 0.1 °C/W.

## Thermal Calculations

To understand the thermal relationship between the output semiconductor junction ( $T_J$ ) and the surrounding ambient temperature ( $T_A$ ) measure the temperature gradient, or drop of temperature, from junction to ambient ( $T_J - T_A$ ); which equals the sum of the thermal resistances multiplied by the junction power dissipation.

$$T_J - T_A = P (R_{\theta JC} + R_{\theta CS} + R_{\theta SA})$$

- Where:  $T_J$  = Junction Temperature, °C  
 $T_A$  = Ambient Temperature, °C  
 $P$  = Power Dissipation ( $I_{LOAD} \times E_{DROP}$ ) watts  
 $R_{\theta JC}$  = Thermal Resistance, junction to case, °C/W  
 $R_{\theta CS}$  = Thermal Resistance, case to sink, °C/W  
 $R_{\theta SA}$  = Thermal Resistance, sink to ambient, °C/W

To use the equation, the maximum junction temperature of the semiconductor must be known, typically 125 °C, along with the actual power dissipation. When these two parameters are known, the third can be found as shown in the following example:

- 1) Determine the maximum allowable ambient temperature, for a 1 °C/W heat sink and a 10 A load (12 watts) with a maximum allowable junction temperature ( $T_J$ ) of 100 °C, and assume a thermal resistance from junction to case ( $R_{\theta JC}$ ) of 1.3:

$$T_J - T_A = P (R_{\theta JC} + R_{\theta CS} + R_{\theta SA})$$

$$= 12 (1.3 + 0.1 + 1.0) \quad \text{hence:}$$

$$= 28.8$$

$$T_A = T_J - 28.8$$

$$= 100 - 28.8$$

$$= 71.2 \text{ °C}$$

- 2) Determine the required heat sink thermal resistance, for 71.2 °C maximum ambient temperature and a 10 amp load (12 watts):

$$R_{\theta SA} = \frac{T_J - T_A}{P} - (R_{\theta JC} + R_{\theta CS})$$

$$= \frac{100 - 71.2}{12} - (1.3 + 0.1)$$

$$= 1 \text{ °C/W}$$

- 3) Determine maximum load current, for 1 °C/W heat sink and 71.2 °C ambient temperature:

$$P = \frac{T_J - T_A}{(R_{\theta JC} + R_{\theta CS} + R_{\theta SA})}$$

$$= \frac{100 - 71.2}{1.3 + 0.1 + 1.0} \quad \text{hence:}$$

$$= 12 \text{ watts}$$

$$I_{LOAD} = \frac{P}{E_{DROP}}$$

$$= \frac{12}{1.2}$$

$$= 10 \text{ amperes}$$

## Heat Sinking

Thermal management is a fundamental consideration in the design and use of solid state relays because of the dissipation (typically 1 watt per amp). It is, therefore, vital that an adequate heat sink is provided, or the life and switching reliability of the SSR will be compromised. In order to properly size a heat sink one has to consider the variables that comprise the thermal resistance  $R_{th}$  (in °C/W).

- Tr:** Temperature rise
- Ta:** Ambient temperature (example 22 °C)
- Th:** Heat sink temperature (example 54 °C)
- Vh:** Voltage to heater (example 12 V)
- Ih:** Current to heater (example 3.5 A)
- Ph:** Power applied to heat sink
- Rth:** Thermal resistance (in °C/W)

Therefore:

$$\begin{aligned} \mathbf{Tr} &= Th - Ta = 54 - 22 = 32 \text{ }^\circ\text{C} \\ \mathbf{Ph} &= Vh \times Ih = 12 \times 3.5 = 42 \text{ W} \\ \mathbf{Rth} &= Tr \div Ph = 32 \div 42 = 0.76 \text{ }^\circ\text{C/W} \end{aligned}$$

Now that we have calculated the thermal resistance ( $R_{th}$ ) we can look at the thermal resistance vs. heat sink volume curve.

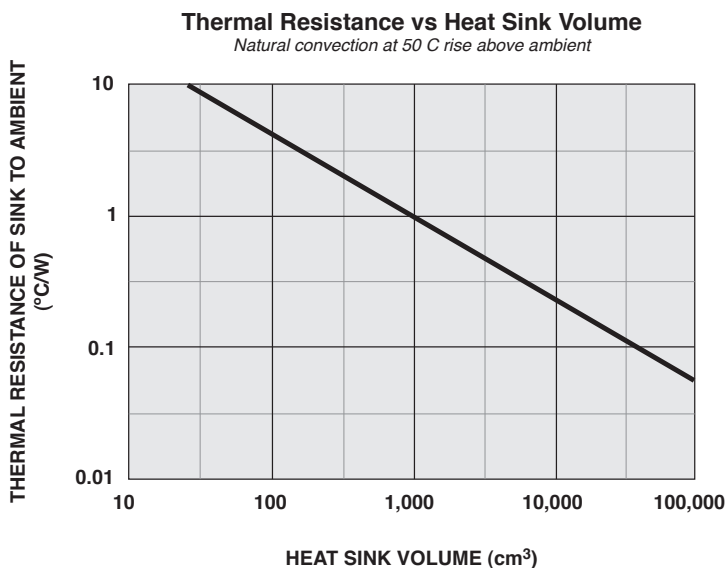

Using this curve with our example above, we can see that a heat sink volume of approximately 1000 cm³ would be needed to successfully sink the amount of heat generated by the device.

---

## Load Considerations

The major cause of application problems with SSRs is improper heat sinking. Following that are issues which result from operating conditions which specific loads impose upon an SSR. Carefully consider the surge characteristics of the load when designing an SSR as a switching solution.

### • Resistive Loads

Loads of constant value of resistance are the simplest application of SSRs. Proper thermal consideration along with attention to the steady state current ratings is important for reliable operation.

### • DC Loads

DC loads are inductive loads. Place a diode across the load to absorb surges during turn off.

### • Lamp Loads

Incandescent lamp loads, though basically resistive, require special consideration. Because the resistance of the cold filament is about 5 to 10 percent of the heated value, a large inrush current can occur. It is essential to verify that this inrush current is within the surge specifications of the SSR. One must also check that the lamp rating of the SSR is not exceeded. This is a UL rating based on the inrush of a typical lamp. Due to the unusually low filament resistance at the time of turn-on, a zero voltage turn on characteristic is particularly desirable with incandescent lamps.

### • Capacitive Loads

These types of loads can be difficult because of their initial appearance as short circuits. High surge currents can occur while charging, limited only by circuit resistance. Use caution with low impedance capacitive loads to verify that the  $di/dt$  capabilities are not exceeded. Zero voltage turn on is a particularly valuable means of limiting  $di/dt$  with capacitive loads.

### • Motors and Solenoids

Motor and solenoid loads require special attention for reliable SSR functionality. Solenoids have high initial surge currents because their stationary impedance is very low. Motors also frequently have severe inrush currents during starting and can impose unusually high voltages during turn off. As a motor's rotor rotates, it creates a back EMF that reduces the flow of current. This back EMF can add to the applied line voltage and create an over voltage condition during turn off. Likewise, verify that the inrush currents associated with mechanical loads having high starting torque or inertia, such as fans and flywheels, are within the surge capabilities of the SSR. Use a current shunt and oscilloscope to examine the duration of the inrush current.

---

## Transformers

In controlling transformers, consider the characteristics of the secondary load because they reflect the effective load on the SSR. Voltage transients from secondary loads circuits, similarly, are frequently transformers and can be imposed on the SSR. Transformers present a special challenge in that, depending on the state of the transformer flux at the time of turn off, the transformer may saturate during the first half-cycle of subsequently applied voltage. This saturation can impose a very large current (10 to 100 times rated typical) on the SSR which far exceeds its half cycle surge rating. SSRs having random turn on may have a better chance of survival than a zero cross turn on device for they commonly require the transformer to support only a portion of the first half cycle of the voltage. On the other hand, a random turn on device will frequently close at the zero cross point and then the SSR must sustain the worst case saturation current. A zero cross turn on device has the advantage that it turns on in a known mode and will immediately demonstrate the worst case condition. The use of a current shunt and an oscilloscope is recommended to verify that the half cycle surge capability is not exceeded.

A rule of thumb in applying an SSR to a transformer load is to select an SSR having a half cycle current surge rating greater than the maximum applied line voltage divided by the transformer primary resistance. The primary resistance is usually easily measured and can be relied on as a minimum impedance limiting the first half cycle of inrush current. The presence of some residual flux plus the saturated reactance of the primary will then further limit, in the worst case, the half cycle surge safely within the surge rating of the SSR.

## Switching Devices

The power family of semiconductors consists of several switching devices. The most widely used of this family are metal-oxide semiconductor field effect transistors (MOSFETs), silicon controlled rectifiers (SCRs), Triac, and Alternistor Triac. In many applications these devices perform key functions and therefore it is imperative that one understand their advantages as well as their shortcomings to properly design a reliable system. Once applied correctly SSRs are an asset in meeting environmental, speed, and reliability specifications which their electromechanical counterparts could not fulfill.

### • MOSFET

A power MOSFET is a specific type of metal oxide semiconductor field-effect transistor (MOSFET) designed to handle large amounts of power. It is a vertical structured transistor capable of sustaining high blocking voltage and high current. Power MOSFET's are used in DC switching applications. Care must be taken to ensure that there is proper polarity for all DC ports. Failure to do so can lead to permanent device damage.

### • Triac

A TRIAC, is an electronic component approximately equivalent to two silicon-controlled rectifiers joined in inverse parallel (paralleled but with the polarity reversed) and with their gates connected together. This results in a bidirectional electronic switch which can conduct AC current only. The Triac is ideal for switching non-reactive loads.

### • Alternistor Triac

The Alternistor has been specifically designed for applications that switch highly inductive AC loads. A special chip offers similar performance as two SCRs wired inverse parallel (back-to-back), providing better turn-off behavior than a standard Triac. The Alternistor Triac is an economical solution; ideal for switching inductive AC loads.

### • SCR

The SCR (silicon-controlled rectifier) acts as a switch, conducting when its gate receives a current pulse, and continue to conduct for as long as it is forward biased. The SCR is ideal for switching all types of AC loads.

## The Magnecraft Range of Solid State Relays

Depending on the application, the Magnecraft line of solid state relays offers a number of advantages over electromechanical relays, including longer life cycles, less energy consumption and reduced maintenance costs.

## Selecting a Solid State Relay

The list below is an example of the specifications to look for when selecting a solid state relay.

Class 1, Division 2 certification (y/n): \_\_\_\_\_

Input voltage: \_\_\_\_\_

Output voltage: \_\_\_\_\_

Load rating: \_\_\_\_\_

Contact configuration: \_\_\_\_\_

Ambient temperature: \_\_\_\_\_

In-rush currents: \_\_\_\_\_

Mounting style: \_\_\_\_\_

Use the catalog specifications or online parametric search to determine a recommended part number ([www.magnecraft.com](http://www.magnecraft.com)).

### More About Class 1, Division 2 Certified Products

Class 1, Division 2 is a classification which was developed by American National Standards Institute (ANSI) to provide requirements for the design and construction of electrical equipment and parts that will be used in hazardous locations. Certified components, when used properly, are not capable of igniting the surrounding atmosphere.

Class 1, Division 2 components may be required in environments which may contain specific flammable gases, combustible dust or fibers that can ignite. The 861H SSR carries a Class 1, Division 2 (Categories: A, B, C, D and Temperature code: T5) approval from Underwriters Laboratories.



The Magnecraft website ([www.magnecraft.com](http://www.magnecraft.com)) was designed to enable users to easily find the proper relay to fit design requirements and to help simplify and shorten workflow.

## Easily find the proper relay to fit design requirements

### ■ Online Catalog

Find the right product by choosing specifications, compare products side-by-side, and view technical specifications, 2D and 3D drawings, and associated accessories.

### ■ Cross Reference Search

Search our comprehensive database to identify products by manufacturer and part number, and link directly to part specifications.

### ■ 3D CAD Library

View, email, download or insert a file directly into your open CAD software pane and select from 18 different file formats.

### ■ Order Free Samples

Magnecraft offers free samples as a courtesy to individuals and companies evaluating our products in their designs and applications. Sample orders are subject to approval.

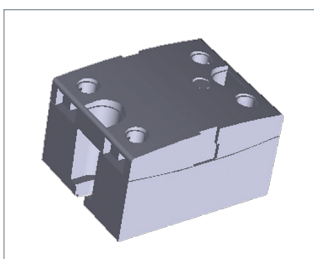

3D Models

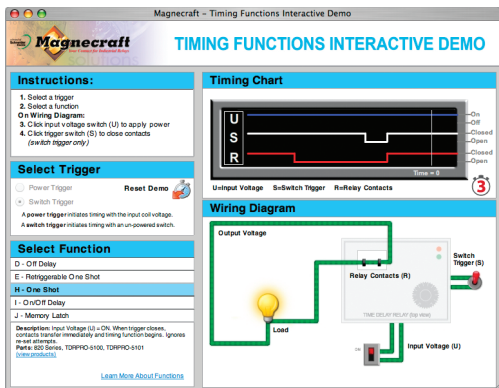

Time Delay Relay Demo

## Simplify and shorten workflow

### ■ Interactive Tools

View interactive demonstrations such as our Time Delay Relay Interactive Demo (left) which visually demonstrates the ten different timing functions offered on Magnecraft time delay relays.

### ■ Distributor Inventory Search

Search authorized distributors' current Magnecraft inventory and buy online. (Buy online not available for all distributors).

**Schneider Electric USA, Inc.**

[www.magnecraft.com](http://www.magnecraft.com)

1300 S. Wolf Rd.  
Des Plaines, IL 60018  
Tel: 847-441-2540

The information and dimensions in this catalog are provided for the convenience of our customers. While this information is believed to be accurate, Schneider Electric reserves the right to make updates and changes without prior notification and assumes no liability for any errors or omissions.

Design: Schneider Electric  
Photos: Schneider Electric

© 2010 Schneider Electric. All Rights Reserved.

October 2010

8501CT1002

# Mouser Electronics

Authorized Distributor

Click to View Pricing, Inventory, Delivery & Lifecycle Information:

[Magnecraft / Schneider Electric:](#)

[6340AXXMDS-DC3](#)