



ENGLISH

Datasheet

Stock No: 211-9235

RS Pro Nitrile Rubber Seal, 48mm Bore, 62mm O.D

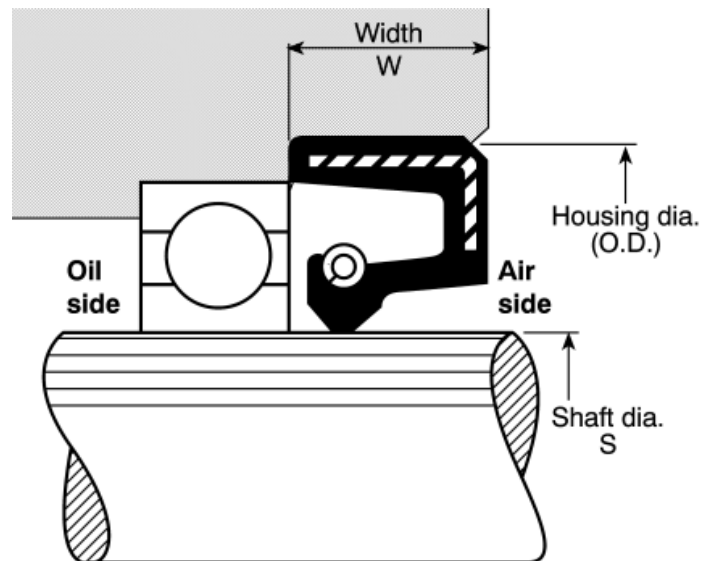
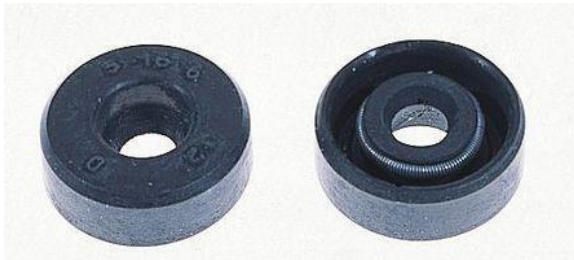

Product Details:

Shaft Seals

Also known as oil seals, these seals are ideal for excluding dirt, dust, water or any other contaminant whilst retaining lubricant in rotary shaft equipment. They are generally used as a means of protecting the bearings of rotating shafts.

- Replaceable without damage to the housing bore
- No need for circlips, sealants or retaining plates

Specifications:

Inside Diameter:	48mm
Outside Diameter:	62mm
Thickness:	8mm
Type:	Shaft Seal
Material:	Nitrile Rubber