

Printed-circuit board connector - DFMC 1,5/16-STF-3,5 - 1790438

Please be informed that the data shown in this PDF Document is generated from our Online Catalog. Please find the complete data in the user's documentation. Our General Terms of Use for Downloads are valid (<http://phoenixcontact.com/download>)

Plug, nominal current: 8 A, rated voltage (III/2): 160 V, number of positions: 16 with 32 contacts, pitch: 3.5 mm, connection method: spring-cage connection, color: green, contact surface: tin

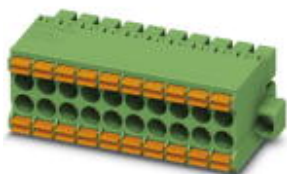

The figure shows a 10-pos. version with 20 contacts

Why buy this product

- Combination with very flat DMC headers
- Versions with and without screw flanges and Lock & Release levers
- Ultra-flat design height of 13.3 mm
- Conductor cross section of up to 1.5 mm²
- Fast conductor connection by means of Push-in direct plug-in technology
- Lock & Release levers lock the plug to the header and also serve as a release tool



Key commercial data

Packing unit	50 pc
GTIN	 4 046356 594882
Weight per Piece (excluding packing)	2.22 g
Custom tariff number	85366990
Country of origin	Germany

Technical data

Dimensions

Length	22.65 mm
Height	13.25 mm
Pitch	3.5 mm
Dimension a	52.5 mm

General

Range of articles	DFMC 1,5/...-STF
Insulating material group	I
Rated surge voltage (III/3)	2.5 kV

Printed-circuit board connector - DFMC 1,5/16-STF-3,5 - 1790438

Technical data

General

Rated surge voltage (III/2)	2.5 kV
Rated surge voltage (II/2)	2.5 kV
Rated voltage (III/3)	160 V
Rated voltage (III/2)	160 V
Rated voltage (II/2)	250 V
Connection in acc. with standard	EN-VDE
Nominal current I _N	8 A
Nominal cross section	1.5 mm ²
Maximum load current	8 A
Insulating material	PA
Inflammability class according to UL 94	V0
Internal cylindrical gage	A1
Stripping length	10 mm
Number of positions	16

Connection data

Conductor cross section solid min.	0.2 mm ²
Conductor cross section solid max.	1.5 mm ²
Conductor cross section stranded min.	0.2 mm ²
Conductor cross section stranded max.	1.5 mm ²
Conductor cross section stranded, with ferrule without plastic sleeve min.	0.25 mm ²
Conductor cross section stranded, with ferrule without plastic sleeve max.	1.5 mm ²
Conductor cross section stranded, with ferrule with plastic sleeve min.	0.25 mm ²
Conductor cross section stranded, with ferrule with plastic sleeve max.	0.75 mm ²
Conductor cross section AWG/kcmil min.	24
Conductor cross section AWG/kcmil max	16
Minimum AWG according to UL/CUL	16
Maximum AWG according to UL/CUL	24

Classifications

eCl@ss

eCl@ss 4.0	272607xx
eCl@ss 4.1	27260701
eCl@ss 5.0	27260701
eCl@ss 5.1	27141190
eCl@ss 6.0	27260704
eCl@ss 7.0	27440402
eCl@ss 8.0	27440309

Printed-circuit board connector - DFMC 1,5/16-STF-3,5 - 1790438

Classifications

ETIM

ETIM 4.0	EC002638
ETIM 5.0	EC002638

UNSPSC

UNSPSC 6.01	30211810
UNSPSC 7.0901	39121409
UNSPSC 11	39121409
UNSPSC 12.01	39121409
UNSPSC 13.2	39121409

Approvals

Approvals

Approvals

UL Recognized / cUL Recognized / VDE Gutachten mit Fertigungsüberwachung / IECCEB CB Scheme / cULus Recognized

Ex Approvals

Approvals submitted

Approval details

UL Recognized 			
		B	C
mm ² /AWG/kcmil	16-24	16-24	
Nominal current I _N	8 A	8 A	
Nominal voltage U _N	150 V	50 V	

cUL Recognized 			
		B	C
mm ² /AWG/kcmil	16-24	16-24	
Nominal current I _N	8 A	8 A	
Nominal voltage U _N	150 V	50 V	

Printed-circuit board connector - DFMC 1,5/16-STF-3,5 - 1790438

Approvals

VDE Gutachten mit Fertigungsüberwachung 	
mm ² /AWG/kcmil	0.2-1.5
Nominal current I _N	8 A
Nominal voltage U _N	160 V

IECEE CB Scheme 	
Nominal current I _N	8 A
Nominal voltage U _N	160 V

cULus Recognized 	
--	--

Accessories

Accessories

Coding element

Coding profile - CP-DMC 1,5 NAT - 1790647

Coding profile, for plugging into the coding ribs of the plug or header at a later date, insulating material, color: natural



Crimping tool

Crimping pliers - CRIMPFOX 6 - 1212034



Crimping pliers, for ferrules without insulating collar according to DIN 46228 Part 1 and ferrules with insulating collar according to DIN 46228 Part 4, 0.25 mm² ... 6.0 mm², lateral entry, trapezoidal crimp

Screwdriver tools

Printed-circuit board connector - DFMC 1,5/16-STF-3,5 - 1790438

Accessories

Screwdriver - SZS 0,4X2,5 VDE - 1205037



Screwdriver, slot-headed, VDE insulated, size: 0.4 x 2.5 x 80 mm, 2-component grip, with non-slip grip

Additional products

Printed-circuit board connector - DMC 1,5/16-G1F-3,5-LR P20THR - 1787153



Header, Nominal current: 8 A, Rated voltage (III/2): 160 V, Number of positions: 16, Pitch: 3.5 mm, Color: black, Contact surface: Tin, Mounting: SMD/THT/THR

Printed-circuit board connector - DMCV 1,5/16-G1F-3,5-LR P20THR - 1787535



Header, Nominal current: 8 A, Rated voltage (III/2): 160 V, Number of positions: 16, Pitch: 3.5 mm, Color: black, Contact surface: Tin, Mounting: SMD/THT/THR

Drawings

Schematic diagram

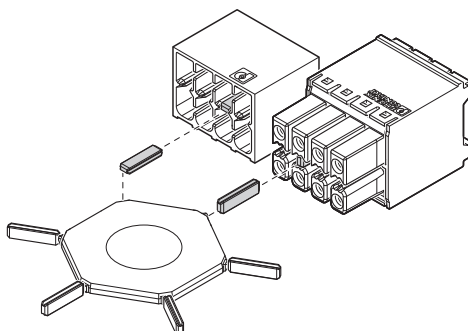

Diagram

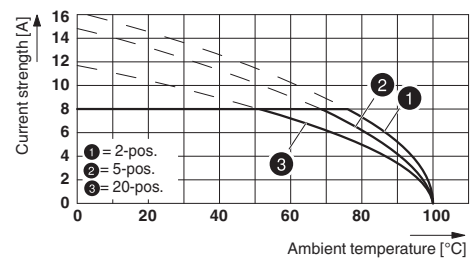

Use of the CP-DMC... coding profile

Printed-circuit board connector - DFMC 1,5/16-STF-3,5 - 1790438

Dimensioned drawing

