

Thank you for purchasing the HAKKO FR-801 SMD rework station.  
Please read this manual before operating the HAKKO FR-801.  
Keep this manual readily accessible for reference.

### 1. PACKING LIST AND PART NAMES

HAKKO FR-801 station	1
Power cord	1
Handpiece holder	1
FP pick-up	1
FP pick-up wire (S)	1
FP pick-up wire (L)	1
Instruction manual	1

\* This product does not include a nozzle. A large selection of nozzles is available for the HAKKO FR-801. Select the nozzle or nozzles suitable for the work to be performed.

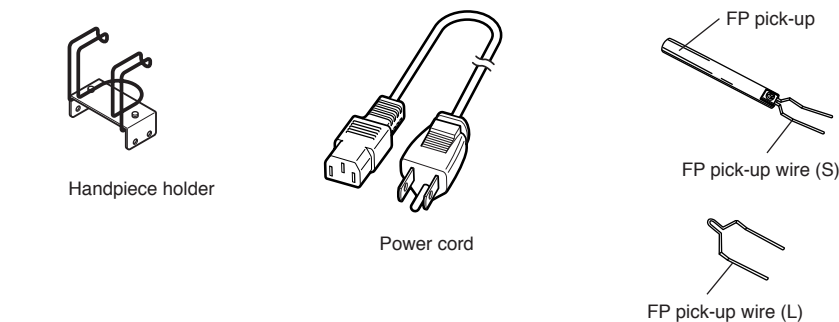
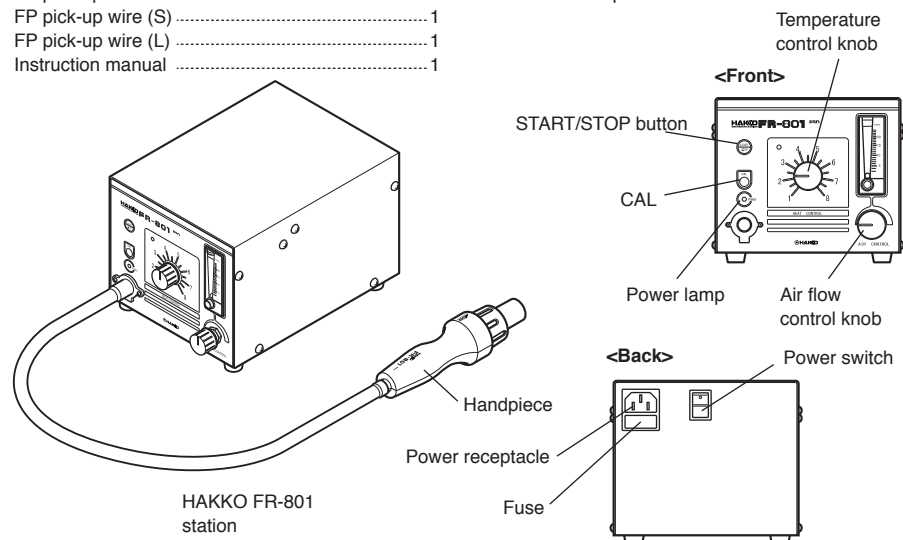

### 2. SPECIFICATIONS

Name	HAKKO FR-801
Power consumption	100V - 310W 110V - 360W 120V - 430W 220V - 570W 230V - 630W 240V - 680W

<b>● Station</b>	
Power Consumption	30 W (Stand-by power consumption 100 - 120V 4W, 220 - 240V 7W)
Pump	Diaphragm pump
Capacity	5 - 20 l/min (max)
Control temperature	100 - 420°C (212 - 788°F) (Use A1126B)
External dimensions	160 (W) × 145 (H) × 230 (D) mm. (6.3 × 5.7 × 9.0 in.)
Weight	4 kg. (8.82 lb.)

<b>● Handpiece</b>	
Power consumption	100V - 280W 110V - 330W 120V - 400W 220V - 540W 230V - 600W 240V - 650W
Total length (w/o cord)	185 (L) mm / 7.3 (L) in.
Weight (w/o cord)	115 g / 0.25 lb.

\*This product is protected against electrostatic discharge.  
\*Specifications and design are subject to change without notice.

### 3. SAFETY INSTRUCTIONS

#### ⚠ WARNING

Warnings, cautions and notes are placed at critical points in this manual to direct the operator's attention to significant items. They are defined as follows:

⚠ **WARNING:** Failure to comply with a WARNING may result in serious injury or death.

⚠ **CAUTION:** Failure to comply with a CAUTION may result in injury to the operator, or damage to the items involved. Two examples are given below.

● Be sure to comply with the following WARNINGS and CAUTIONS for your safety.

#### ⚠ WARNING

- Be sure not to operate the unit with any combination of temperature and air flow settings that makes the thermal protector trip (the heater lamp turns off during use). This could damage the unit.
- After use, do not turn off the power switch and do not disconnect the plug during the automatic cool-down process.

#### ⚠ CAUTION

When the power is ON, the temperature of the hot air and the nozzle ranges from 100 to 600°C. (212 to 1,112°F.). To avoid injury or damage to personal and items in the work area, observe the following:

- Do not direct the hot air toward personnel or touch the metal parts near the nozzle.
- Do not use the product near combustible gases or flammable materials.
- Inform others in the area that the unit is hot and should not be touched.
- Turn the power off when not in use, or left unattended.
- Turn the power off when changing parts or storing the HAKKO FR-801.

To prevent accidents or damage to the HAKKO FR-801, be sure to observe the following:

- Do not strike the handpiece against hard surfaces or otherwise subject it to physical shock. This will damage the quartz glass shield around the heating element, and could damage the heater as well.
- Be sure the unit is grounded. Always connect power to a grounded receptacle.
- Do not disassemble the pump.
- Do not modify the unit.
- Use only genuine HAKKO replacement parts.
- Do not wet the unit or use the unit with wet hands.
- Remove power cord by holding the plug - not the wires.
- Make sure the work area is well ventilated.
- The HAKKO FR-801 is not intended for use by children or infirm persons without supervision.
- Children should be supervised to ensure that they do not play with the HAKKO FR-801.

### 4. INITIAL SETUP

#### A. Station assembly

- **Attach the handpiece holder.**  
Remove the handpiece holder mounting screw from the side of the station. Attach the handpiece holder to the station. (Figure 1) (The handpiece holder can be installed on either the left or right side.)

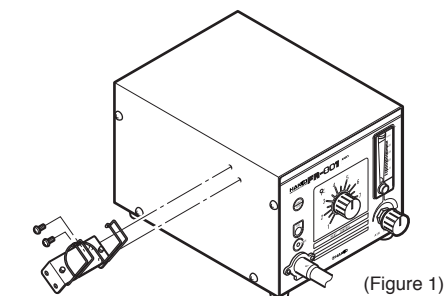

#### B. Handpiece assembly

- **Attach the nozzle.**  
Loosen the nozzle mounting screw. Attach the nozzle as shown in the drawing. (Figure 2)

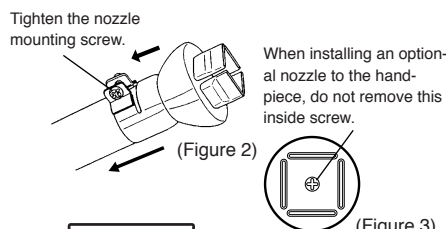

#### C. Electrical connection and power ON

1. Connect the power cord to the power receptacle on the back panel of the station. (Figure 4)
2. Place the handpiece on the holder. (Figure 5)
3. Plug the power cord into a grounded wall socket.
4. Turn the power switch ON.  
The power lamp will light on.
5. Press down the (START/STOP) button. The blowing function will start and the heating element will begin to warm up.

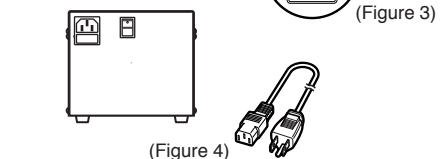

⚠ **CAUTION**  
This product is protected against electrostatic discharge. Be sure to use a grounded wall socket.

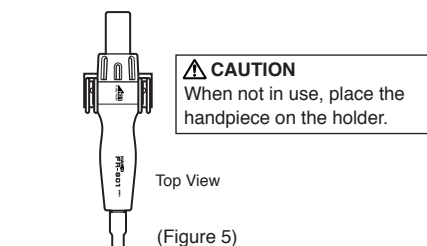

### 5. OPERATION

#### ● QFP Desoldering

1. Adjust the air flow and temperature control knobs. Adjust the flow rate of the hot air while watching the center of the ball. Wait for the temperature to stabilize for a short period of time.

⚠ **WARNING**  
If the thermal protector is tripped, reduce the temperature setting or increase the air flow. Be sure not to operate the unit with temperature and air flow settings that makes the thermal protector trip. This could damage the unit.

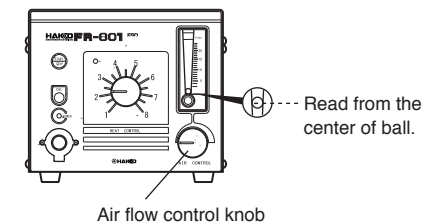

#### 2. Place the FP pick-up under the IC lead.

Slip the FP pick-up wire under the IC lead. (Figure 1)  
If the width of the IC does not match the size of the FP pick-up, adjust the width of the pick-up by squeezing the wire. In case of PLCC or small components such as chip resistors, desolder by using tweezers, etc.

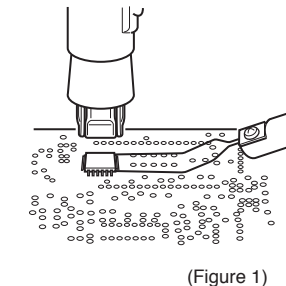

#### 3. Heating

Hold the handpiece so that the nozzle is located directly over, but not touching the IC, and allow the hot air to melt the solder. Be careful not to touch the leads of the IC with the nozzle.

#### 4. Remove the IC.

Once the solder has melted, remove the IC by lifting the FP pick-up. (Figure 2)

#### 5. Remove any remaining solder.

After removing the IC, remove remaining solder with a soldering iron and wick or desoldering tool.

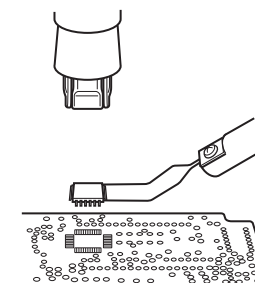

#### ● QFP Soldering

#### 1. Apply the solder paste.

Apply the proper quality of solder paste and install the SMD on the PWB.

#### 2. Preheat the SMD.

Refer to the figure 3 to preheat SMD.

#### 3. Soldering

Heat the lead frame evenly. (Figure 4)

#### 4. Cleaning

When soldering is completed, clean the residual flux from the board with an appropriate cleaner.

⚠ **CAUTION**  
Soldering with hot air has many advantages, such as the inherent ability to pre-heat the component being replaced. As with any soldering process, however, there is always the possibility of forming solder balls, bridges between leads, and inadequate solder joints. Always inspect the finished solder joints for structural and electrical integrity.

#### ● Press down the (START/STOP) button.

After the (START/STOP) button is pressed down, an automatic blowing function begins sending cool air through the pipe in order to cool the handpiece. Do not disconnect the plug during this cooling process.

⚠ **CAUTION**  
During the cooling process, the amount of air is controlled by the setting of the air flow adjustment knob. HAKKO recommends setting the knob at maximum when cooling for greatest efficiency.

#### ● Turn the power switch off.

After the flowing function finished, turn off the power switch.

#### ● Turn the power switch off.

HAKKO FR-801 has CAL (calibration) volume to have fine adjustment for the calorific value of heat except the temperature control knob.

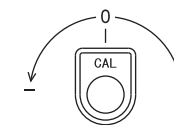

- Use a small plus screwdriver to adjust the screw marked CAL at the front panel. Turn the screw clockwise to increase the temperature and counterclockwise to reduce the temperature.

**NOTE:**  
HAKKO FR-801 comes from the factory with zero (0) value preset.

## 6. MAINTENANCE / INSPECTION

### ● Broken heating element

#### ⚠ CAUTION

Replacing the heating element is very dangerous. Be sure to turn the power switch OFF and be careful of the following procedure when replacing the heating element.

#### A. Open the handpiece

1. Move the tube away from the handpiece, as shown. (Figure 1)
2. Remove the three screws holding the handpiece together.
3. Open the handpiece. Disconnect the grounding wire sleeve (1) and pipe from the protruding portion of the handle. Remove the pipe.

#### ⚠ CAUTION

Quartz glass and heat insulation are inside the pipe. Be careful not to drop or lose these items.

4. Disconnect the connector (2) and remove the heating element.

#### B. Measure the resistance value

Connect an ohmmeter across the connector terminals (a). The correct values are approximately: 26-40Ω (100-120V), 70-100Ω (220-240V). If the resistance value is incorrect, replace the part. (Refer to the instructions included with the replacement part.)

#### ⚠ CAUTION

Handle the heating element with care. Never rub the heating element wire! Insert the handle's projection into the hole in the pipe.

### ● Replacing the fuse

1. Unplug the power cord from the power receptacle.
2. Remove the fuse holder.
3. Replace the fuse.  
5A (100-120V), 3.15A (220-240V)
4. Put the fuse holder back in place.

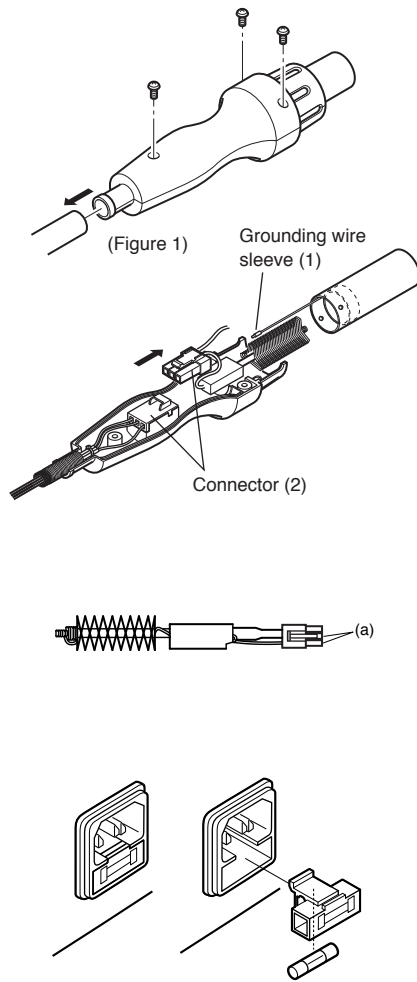

## 7. OPTIONAL NOZZLES

#### ⚠ CAUTION

The size in Name/Specification indicates the size of IC package.

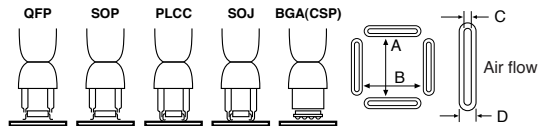

Unit: mm

Part No.	Part Name	Specifications
A1124B Single $\phi 2.5$ (0.09)	A1125B QFP 10 × 10 (0.39 × 0.39)	A1126B QFP 14 × 14 (0.55 × 0.55)
A1127B QFP 17.5 × 17.5 (0.68 × 0.68)	A1128B QFP 14 × 20 (0.55 × 0.78)	A1129B QFP 28 × 28 (1.1 × 1.1)
A1130 Single $\phi 4.4$ (0.17)	A1131 SOP 4.4 × 10 (0.17 × 0.39)	
A1132 SOP 5.6 × 13 (0.22 × 0.51)	A1133 SOP 7.5 × 15 (0.3 × 0.59)	A1134 SOP 7.5 × 18 (0.3 × 0.7)
A1135B PLCC 17.5 × 17.5 (0.68 × 0.68) (44 Pins)	A1136B PLCC 20 × 20 (0.78 × 0.78) (52 Pins)	
A1137B PLCC 25 × 25 (0.98 × 0.98) (68 Pins)	A1138B PLCC 30 × 30 (1.18 × 1.18) (84 Pins)	A1139B PLCC 12.5 × 7.3 (0.49 × 0.29) (18 Pins)
A1140B PLCC 11.5 × 11.5 (0.45 × 0.45) (28 Pins)	A1141B PLCC 11.5 × 14 (0.45 × 0.55) (32 Pins)	
A1142B Bent Single 1.5 × 3 (0.06 × 0.12)	A1180B BQFP 17 × 17 (0.67 × 0.67)	A1181B BQFP 19 × 19 (0.75 × 0.75)
A1182B BQFP 24 × 24 (0.94 × 0.94)	A1183 SOJ 15 × 8 (0.59 × 0.31)	

## 7. OPTIONAL NOZZLES

A1184B SOJ 18 × 8 (0.71 × 0.31)	A1185B TSOL 13 × 10 (0.51 × 0.39)	A1186B TSOL 18 × 10 (0.71 × 0.39)	A1187B TSOL 18.5 × 8 (0.73 × 0.31)	A1188B PLCC 9 × 9 (0.35 × 0.35) (20 Pins)
A1189B PLCC 34 × 34 (1.34 × 1.34) (100 Pins)	A1190 Dual Single 2.5 × 9.5 Pitch (0.09 × 0.37)	A1191 SIP 25L (0.98)	A1192 SIP 50L (1.97)	
A1203B QFP 35 × 35 (1.38 × 1.38)	A1214B SOJ 10 × 26 (0.39 × 1.02)	A1215B QFP 42.5 × 42.5 (1.67 × 1.67)	A1257B SOP 11 × 21 (0.43 × 0.83)	A1258B SOP 7.6 × 12.7 (0.3 × 0.5)
A1259B SOP 13 × 28 (0.51 × 1.1)	A1260B SOP 8.6 × 18 (0.34 × 0.71)	A1261B QFP 20 × 20 (0.78 × 0.78)	A1262B QFP 12 × 12 (0.47 × 0.47)	A1263B QFP 28 × 40 (1.1 × 1.57)
A1264B QFP 40 × 40 (1.57 × 1.57)	A1265B QFP 32 × 32 (1.26 × 1.26)	A1325 Dual Single $\phi 1.5 \times 5-10$ (0.06 × 0.2-0.39) Adjustable Pitch		
A1470 BGA 8 × 8	A1471 BGA 12 × 12	A1472 BGA 13 × 13	A1473 BGA 15 × 15	A1474 BGA 18 × 18
A1475 BGA 27 × 27	A1476 BGA 35 × 35	A1477 BGA 38 × 38	A1478 BGA 40 × 40	

## 8. PARTS LIST / HANDPIECE

#### NOTE:

Spare or repair parts do not include mounting screws, if they are not listed on the specifications. Screws must be ordered separately.

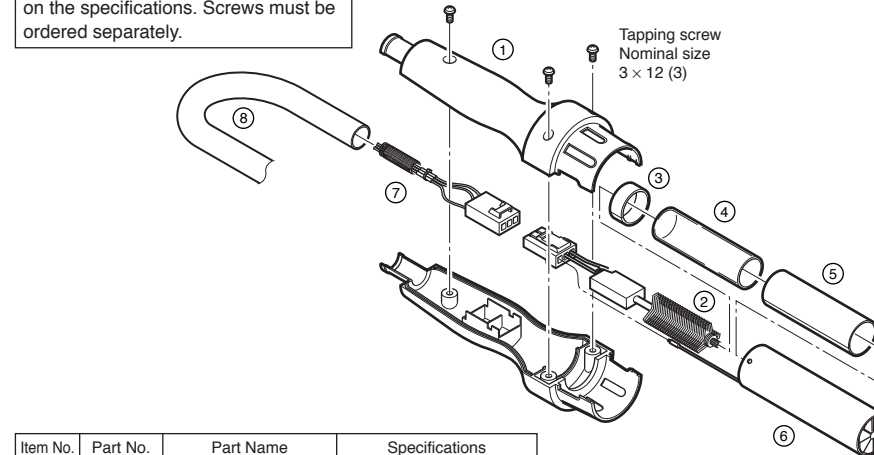

Item No.	Part No.	Part Name	Specifications
①	B3005	Handle	With screws
②	A1521	Heating element	100 - 120V
	A1522	Heating element	220 - 240V
③	B3009	Mica pipe B	
④	B2995	Quartz glass pipe	For support heating element
⑤	B3008	Mica pipe A	
⑥	B3004	Pipe	
⑦	B3007	Cord assembly	With silicone tube
⑧	B1188	Silicone hose	

## 8. PARTS LIST / STATION

#### NOTE:

Spare or repair parts do not include mounting screws, if they are not listed on the specifications. Screws must be ordered separately.

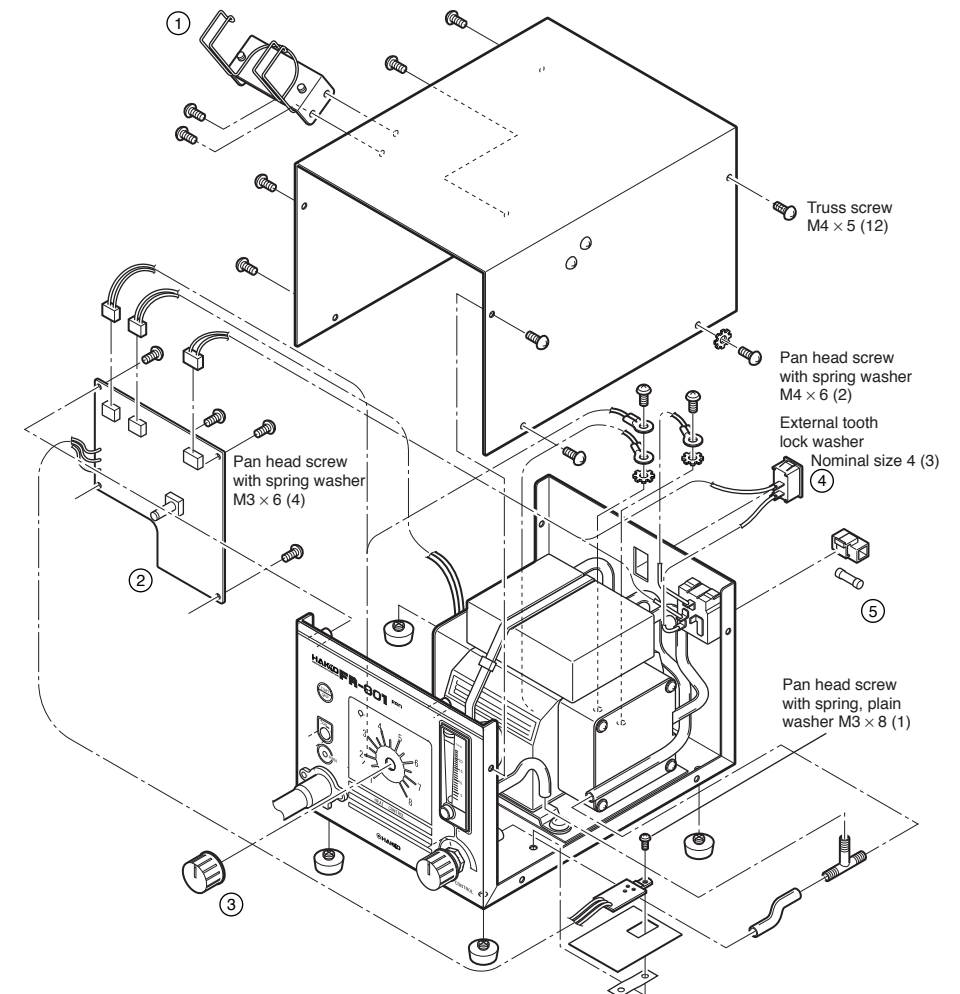

Item No.	Part No.	Part Name	Specifications
①	B3006	Handpiece holder	
②	B3002	P.W.B.	100V, with potentiometer, triac
	B3003	P.W.B.	110V, with potentiometer, triac
	B3049	P.W.B.	120V, with potentiometer, triac
	B3030	P.W.B.	220V, with potentiometer, triac
	B3031	P.W.B.	230-240V, with potentiometer, triac
③	B1028	Knob	With screw
④	B1084	Power switch	
⑤	B2468	Fuse/125V-5A	100-120V
	B1258	Fuse/250V-3.15A(S)	220-240V
⑥	B2419	Power cord, 3 wired cord & American plug	
	B2421	Power cord, 3 wired cord but no plug	
	B2422	Power cord, 3 wired cord & BS plug	India
	B2424	Power cord, 3 wired cord & European plug	220V KTL, 230V CE
	B2425	Power cord, 3 wired cord & BS plug	230V CE U.K.
	B2426	Power cord, 3 wired cord & Australian plug	
	B2436	Power cord, 3 wired cord & Chinese plug	China

### ● Optional Parts

Item No.	Part No.	Part Name	Specifications
①	B1438	FP pick-up	With 1pc. of pick-up wire (S) & (L)
②	B1439	FP pick-up wire (S)	
③	B1440	FP pick-up wire (L)	

