

Easy-PC

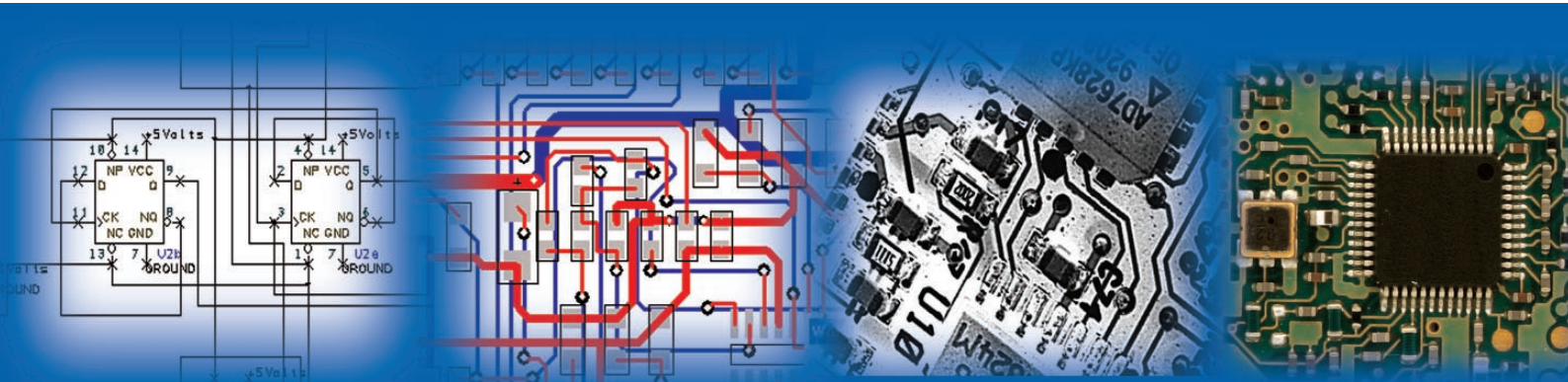

Schematic Capture, PCB Layout, Libraries, Autorouting



World-beating value

Delivering performance in Schematic Capture and PCB Layout normally associated with products at ten or even twenty times the price, Easy-PC rightly deserves the accolade: "World-beating".

Easy-PC has been created by a team of software professionals with some 200 man years experience in development of leading-edge Electronic Design Automation solutions. The team has rewritten the rule book for EDA tools designed for low to high complexity PCB layouts.

Easy-PC is packed with time saving features to make the task of PCB design and layout so much quicker and more pleasurable.

Simple to learn and understand, yet packed with powerful features

Easy-PC was designed to be quite simple to learn so that you, the customer, are productive within a few hours of practice with the product. Frequently, new customers report they are producing their first board within a few days of installing the software - it really is that simple and intuitive!

Take a look at Easy-PC...

We're sure you will be impressed!

Just a glance at the following pages will show immediately the extensive range of capability within this exciting product. We hope to include you as a much valued customer in the near future.

Number One Systems' commitment to the future

Another reason for the remarkable enthusiasm for Easy-PC is the Number One Systems commitment to continual development and expansion of the product. Every year we offer our existing much valued customers a new version of the product at a reasonable upgrade price, including a package of new features and enhancements. Many of these are new developments based on feedback from the many thousands of customers using Easy-PC on a daily basis. Thus we ensure our customer's investment in software design tools are kept up-to-date and abreast of changes in technology.

What our customers say about Easy-PC -

"Each version has been an improvement on the last one, in my view it represents the best value for money on the market"

- Custom Cameras Ltd., Mr R Harris

"We never expected such a professional PCB system at this price"

- CMS (UK) Ltd., Mr John Miles

"Brilliant software. Very easy to use"

- Malcolm Bell (London) Ltd., Mr M Bell

"You have very good customer service, impressive"

- AC/DC Lighting Systems, Mr John Gallagher

"Easy-PC for Windows is an excellent program, I am extremely pleased with it"

- Mr J Bence, Newbury, Berks, UK

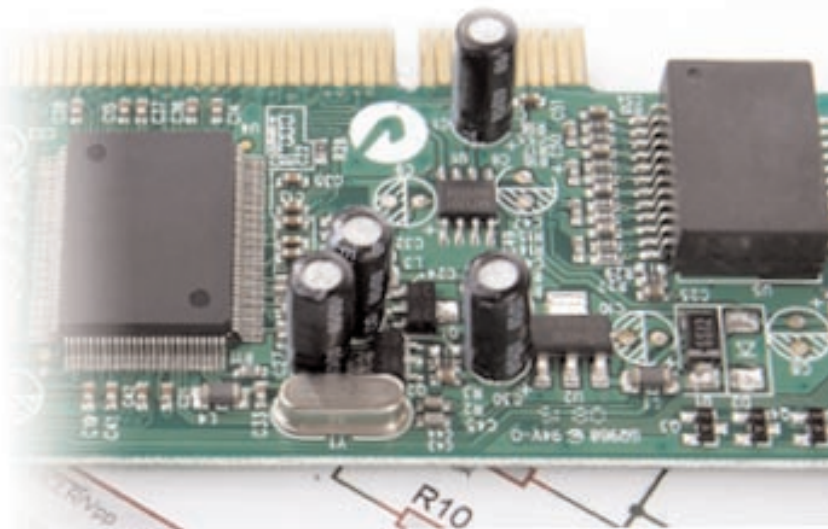

Unlimited Schematic Capture included as standard on all PCB Layout variants.

Full Windows Operating System Support: Windows Vista, Windows 7 & 8

Integrated SCM/PCB Designs

Easy-PC Schematic and PCB designs are kept fully synchronised at all times ensuring full design integrity without the use of netlists. Or if you prefer, simply design your PCB on-the-fly without using a Schematic design at all.

True-Type Fonts

Transistor DC Level
transient Silk Screen

Access to all the fonts on your PC gives your designs and prints an easier to read and more professional appearance.

Context Sensitive Shortcut Menus

Extensive use of shortcut menus from the right mouse button significantly reduces menu searching, making options that much quicker to use.

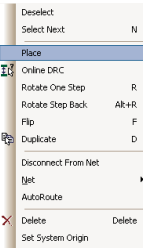

Windows User Interface

The Easy-PC interface is a similar layout to your Microsoft Office applications which makes it easy to learn and with an instantly familiar feel.

True Windows 32-bit Application

Easy-PC is a true Windows 32-bit application with design resolution down to 0.1 micron.

Windows Drag & Drop

The standard Windows 'drag & drop' methodology of click and drag is used throughout Easy-PC to simplify the design process.

Fully Customisable Interface

Toolbars, the user interface and keyboard shortcut keys are all fully and easily customisable in Easy-PC using one Windows standard dialog.

Sliding Windows

Once you use these you'll wonder how you ever managed without them! Simply hover the mouse over the named tab to display the browser.

Instant Cross Probing

Being a fully integrated application, Easy-PC provides instant cross-probing. Just click on the component or connection in Schematics and see the corresponding component instantly highlighted in the PCB, or click on a footprint or track in PCB and see it highlighted in the Schematic.

Rotate to 1/100th Degree

Any item in the design including components, text and attributes can be rotated to down to 1/100th of a degree. Normal fixed rotations of 90 and 45 degrees can be applied using shortcut keys for speed during design.

Technology Support

Easy-PC fully supports through-hole designs, surface mounted components and mixed technologies.

Mouse Wheel Controlled Pan & Zoom

Instant Zoom In/Out by rolling the mouse wheel forward or backwards. Pan using a single click of the wheel, or holding down the wheel for dynamic pan across the design.



Import Designs & Libraries from Other Systems

Easy-PC can import designs and libraries from BoardMaker, Easy-PC DOS, Ultiboard and Eagle. Imported designs are rebuilt as though you had created them from scratch in Easy-PC.

Intelligent Copy & Paste

Copy & Paste of design items will automatically renumber the pasted item. Also, Copy to Bitmap is available for export to your documentation systems.

Multi-level Undo & Redo

Easy-PC has unlimited undo and redo levels. Create your designs in the knowledge that you can undo mistakes or previous iterations using standard Windows commands.

Library Creation Wizards

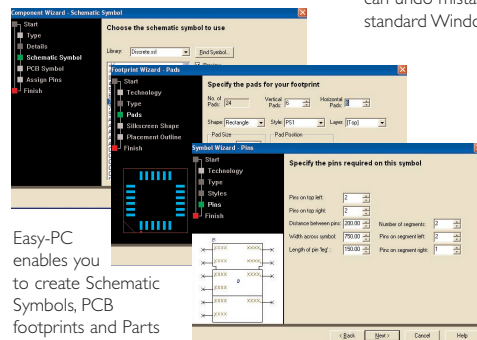

Easy-PC enables you to create Schematic Symbols, PCB footprints and Parts simply and efficiently.

Easy-to-use wizards guide you step-by-step through a sequence of operations resulting in the automatic generation of new library items.

Many Schematic symbol types are quickly created saving time. Intricate and often, fine-pitched PCB Footprints are created using parameter driven dialogs. The Component Wizard marries the Symbols and Footprints together in the component library.

Goto Browser

Fast Find of items in the design.

Layers Browser

Fast display and switching of layers.

Component Bin

This provides a handy 'off-design' location for Schematic and PCB components during the design process. Components are stored here ready to be dragged into the design by selecting their name or preview picture.

Add Component Browser

The component browser offers a fast and convenient drag & drop component selection mechanism in addition to the normal Add Component option.

World View

Displays a 'thumbnail' preview of the complete design. Using the Pan & Zoom options in this window allows the 'real' view in the design to be changed. This enables the whole design to be viewed outside the design area without disturbing it.

Status Bar

Gives you instant Property status on any selected item in the design without the need to use a query or the Properties dialog. All common property information is contained within the status bar display.

Library Management Tools

Easy-PC provides effective graphical tools to manage, edit and update your library components simply and efficiently.

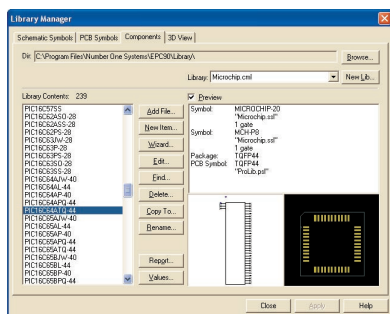

What our customers say about Easy-PC:

"Very user-friendly system with unlimited possibilities to create the finest PCB designs. Easy and logical, time saving - that's Easy-PC for you"

- AudioX PX, Mr Alex Vaas. Finland

"I had to write and say how impressed I am with Easy-PC. This tool just keeps getting better and better. Thank you and congratulations on a great product"

- Pride Embedded LLC, Mr Bruce M. Pride. USA

"Great product!"

- Active Robots Ltd., Mr Anthony Lovedale. UK

Integrated Schematic Capture & PCB Layout

Create Clear & Concise Schematics

The Easy-PC Schematic editor allows you to create clear and concise schematic drawings. Multi-sheet drawings can be easily combined within a Project file, allowing all net names and component names to be managed and synchronised. The design tools have been produced with influence from our existing professional user base.

Colour by net in Schematics

To aid recognition of important nets when designing your Schematic, each net can be given its own colour. These colours can be set up in the Schematic Technology, allowing you to define standard net colours for all your designs.

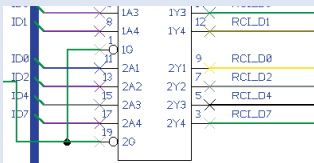

Sketch Connections

Interactive Schematic Routing enables you to guide the routing path for electrical connections within your schematic design. With point-to-point routing and 'sketch' path mode, schematic connection routing has never been so easy.

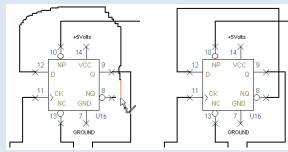

Intelligent Busses

Intelligent bus items can be drawn in the design with ease. These busses can be 'closed' containing specific net names, or they can be left 'open' to give you flexibility. Bus nets can be drawn with connective nets or left named for full implied (invisible) connectivity.

Forwards and Backwards

Design Annotation

Updates and modifications to Schematics can be passed forward to PCB with name changes in PCB being back annotated to the Schematic design.

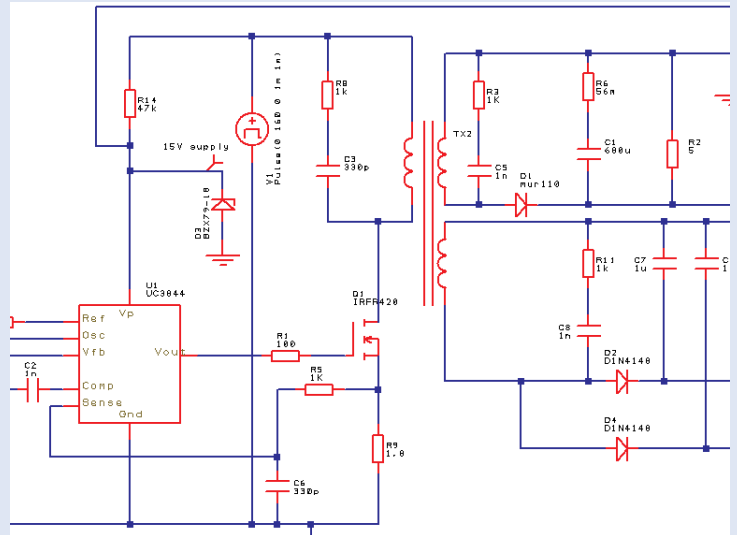
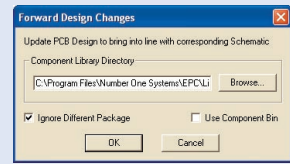

Online Design Rules Checking

With Online DRC switched on, error markers instantly indicate design rule spacing errors and the error location during the design layout process.

Shape Based Copper Pour

Easy-PC provides fast copper pouring with control on thermal relief, isolation gap and number of spokes, plus removal of unwanted copper 'islands'. Flexible, powerful and easy-to-use, add copper of any shape to the design.

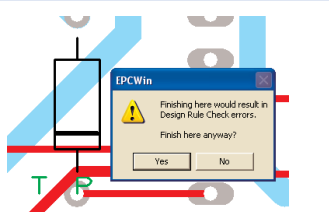

Split Powerplanes & View Powerplanes

Easy-PC offers full support for split and partial powerplanes. The view powerplane facility enables you to view the powerplane using the same mechanism as used for generating it at the Plotting stage - accurate and not just a "bitmap" image.

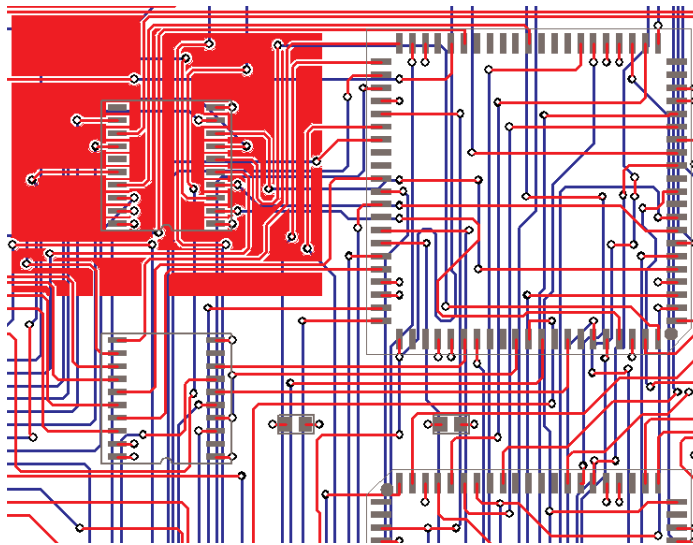
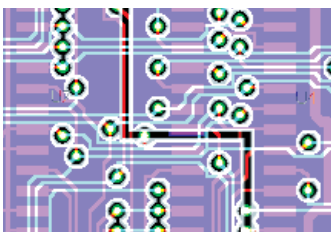

Import/Export DXF

Create those complex board shapes in your mechanical CAD system and bring them directly into Easy-PC. You can export design elements in DXF format as well.

Autoplace

Autoplace is provided as standard with Easy-PC. With an easy-to-use dialog it allows you to place or test-place components from your component bin for suitable placement positions within the design.

User Defined Parts List and Pick & Place Output

Customisable Parts Lists and Pick & Place machine outputs can be quickly and easily created. Standard reports are also supplied to get you started.

Name	Component	Side	Centre	Rotation
C2	C	Top	(3050.00,3150.00)	90
C3	CP3	Top	(2775.00,2450.00)	0
C:ONN1	6464M	Top	(4550.00,2167.50)	270

Trace-Router

Autorouter

The Trace-Router autorouter is the latest productivity development released from Number One Systems. As a direct replacement for the Easy-Router autorouter, the Trace-Router brings the latest routing technology into your Easy-PC PCB designs. The Trace-Router is based on a numerically stable mathematical topology which means it is capable of routing the finest pitched devices and highest routing

density. With the Easy-PC philosophy of ease-of-use ever in-mind, it ensures your designs are completed and driven to market even quicker. Trace-Router is totally integrated within the Easy-PC PCB design environment, there is no additional routing window or translation from one system to another, and no 'additional' processes to go through. It is run from a single, control dialog with no other user interaction required. Trace-Router is so easy to set-up and use; you can design and change parameters iteratively throughout the design cycle at any time.

Single Shot Postprocessing

Easy-PC delivers the latest technology in single button press plotting. You can build 'job files' to generate all the plots required for a design which can be produced with a single mouse 'click'. All plots can be created on this one easy-to-use dialog.

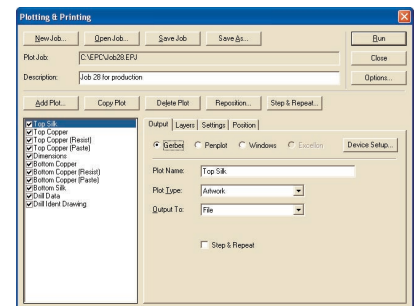

What our customers say about Easy-PC:

"An incredible package for the price - well done, thanks"
- ATC Systems, Mr Alex Chater. UK

"And again 'officially', thank-you for the excellent tech support line. It is a major factor in my ongoing investment in your software"
- Mr T K Boyd, Chichester, UK

"Excellent value for money and very intuitive..."
- Soul Technology Ltd., Mr Paul Jennings. UK

"I had struggled for 12 years with Eagle, then I changed to Easy-PC for Windows. It has been worth the trouble. 'Easy' is the best description of the PCB program."
- BAM, Mr Thomas Berstein. Germany

Advanced Auto-Router

Pro Router

Optional Powerful Adaptive Strategy Autorouter

Pro-Router delivers a higher dimension of autorouting performance for Easy-PC users with fast, high completion rate auto-routing on the most densely packed, multi-layer PCB designs. A high performance router delivering minimal overall track lengths and via counts; Pro-Router provides the ideal routing solution for large or complex designs.

Pro-Router is a new generation of autorouting software using a multi-pass cost-based conflict

Features

- Unlimited Power Plane layers
- Gridless routing of up to 256 layers
- Via size by net class
- SMD escape fanout control
- Routes SMDs on both sides
- Memory routing pass
- Split Plane/Ground Planes support
- Customisable cost factors
- Post-route cleanup optimisation
- Runs under Windows Vista, Win 7 & Win 8
- Available with Easy-PC V12.0 onwards

reduction algorithm to find a routing solution adapting to the natural flow of the nets. Adaptive routing algorithm is the only proven approach to reach high completion rates on the modern generation of designs. It gives you the quality of routing results frequently associated with manually routed designs. Plus, speed and completion rates normally only associated with auto-routers at 20x to 40x the price of Pro-Router:

With 7 variants, Pro-Router is available to suit all budgets and design complexities. See the datasheet online for the full list.

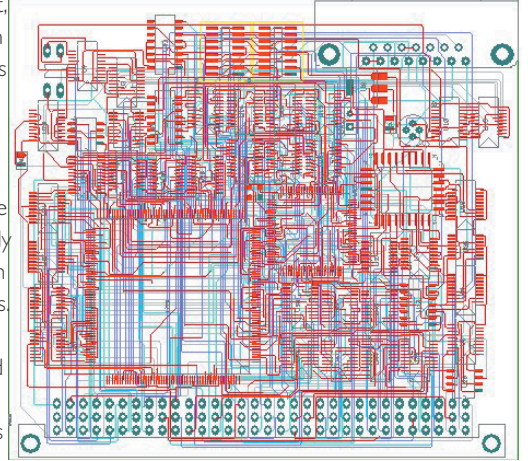

53 components, 1287 component pins, 4 layer, routed 100% using Pro-Router in 6 minutes on 2.0 Ghz Pentium

NB Pro-Router requires Easy-PC V12.0 onwards to run.

Cost Options

Intelligent Gerber Import

Rebuild your Gerber files intelligently and effortlessly as though they originated from Easy-PC. This exciting option allows track paths, vias, pads and pad stacks as well as full connectivity to be rebuilt. Components can be rebuilt back to libraries for reuse.

Gerber Import

With the minimum amount of effort, the Gerber Import facility enables Gerber files in RS-274-D and RS-274-X format to be imported and viewed in a PCB design window. These files can be added to existing designs, or simply viewed before manufacture for checking purposes.

GenCAD Export

When your manufacturer requires an advanced manufacturing output for driving assembly or test machines, the GenCAD format is often specified. To facilitate this requirement, this cost option interface writes an ASCII text file in GenCAD format. Pre-formatted to an exact specification, this format is reliable and proven in the industry.

IDF 3.0 Export

The IDF 2.0 and 3.0 Export option allows you to export your designs into your mechanical CAD (MCAD) system using the industry standard IDF format. IDF provides an alternative format to DXF for systems which do not support the AutoCAD DXF format or where 3D component data is required.

Additional Libraries

Easy-PC is supplied with a set of libraries which cater for generic and general use components. These are 'everyday' items which will help you get started with the design process. However, as is generally the case, it may not contain everything you require immediately. You may create your own library items and add them to the existing libraries.

The optional libraries detailed below provide you with sets of specific manufacturers components in a ready-to-use library format. Each set has been created around the manufacturer's datasheets to save you time sourcing and creating the devices.

Micro Library

The optional Microprocessor Library contains over 9,700 supplementary components including Schematic and PCB symbols. This library has microprocessor and processor associated chip sets. These often time-consuming and complicated library items are packaged in manufacturer sets to assist you in identifying them quicker. They are created based on the latest manufacturer datasheets and include all symbol detail, component detail and logic names.



Pro Library

A customised library of over 82,600 Parts with their associated Schematic Symbols and PCB footprints for Easy-PC. Even with time saving Wizards and ease-of-use in Easy-PC, the Pro Library saves you hours of tedious trawling through databooks and web sites where the work has already been done for you. All facets of the libraries and symbols can be used and reused on other similar Parts when an exact match is not available.

IPC-SM Library

The optional IPC-SM standard Library contains supplementary component and PCB symbol libraries for use with any variant of Easy-PC For Windows. These have been created to the IPC Council's standard for surface mounted device land patterns. The PCB symbol library contains 1,200 surface mount devices in a range of package types.

Connector Library

Connectors come in all shapes and sizes. With Easy-PC we've made it easy for you by researching and creating the connectors from the manufacturers datasheets. Everything you need to simply find and drop the connectors from the Easy-PC library into your design has been supplied; Schematic Symbols, PCB footprint symbols and the Connector Component itself.

With over 15,900 connector parts, this library represents a cost-effective solution for your Easy-PC design system.

Types of connectors included in this new library are: Edge Connector, Sockets, Headers, Micro Headers, Pin & Pinless Headers, Micro D, Nano Miniature, Ribbon Cable, USB Type A, Free Hanging, Right Angle, Vertical, Flat Flex, PCB Mounted Jacks, Terminal Blocks.



Feature Summary:

- True 32-bit Windows application
- Multiple Window interface
- Schematic capture and PCB Design
- Technology files for rapid design setup
- True Connective data model
- Database resolution down to 10 µm
- Rotation to 0.01 (1/100th) degree
- Unlimited number of Electrical/Documentation Layers
- Unlimited elements per design
- Design in Imperial or Metric units, no rounding errors
- Drawing area up to 1.0 m by 1.0 m (39" by 39")
- Multi-level Undo and Redo
- Cut, Copy, Paste and Duplicate of all design data
- Two optional integrated Autorouters
- Automatic Via stitching into Copper Areas and Tracks
- Assembly Variants
- Schematic Hierarchy
- Integrated Autoplace
- Shape-based copper pouring in PCB
- True split & partial power planes
- Supports any shape board outlines including round
- Manual PCB design routing 'sketch' mode
- On-line & batch Design Rules Checking (DRC) PCB
- Batch Design Rules Checking in SCM
- Intelligent Schematic bussing
- 'Sketch' connection mode in SCM
- Spice netlist export in SCM
- User configurable Parts List output
- World View and Component Bin windows
- Sliding window browser with instant layer selection
- Auto update of PCB with design changes from SCM
- Back annotation of Net & Component names to SCM
- 'Align' item feature
- Automatic component rename in PCB
- Cross probing between Schematics and PCB
- Component/PCB Footprint/Schematic Symbol Wizards
- Library Manager for component management
- Databook designer mode for library documentation
- Customisable toolbars and shortcut keys
- Supports SMT, through-hole and mixed technology
- SMT supported on both sides of the board
- Support for Slotted pads
- Supports single-sided designs
- Fast find of nets/comps
- Dynamic Pan, Zoom In and Out and Frame Views
- User defined layer types
- Find facility in libraries
- TrueType font support
- Save/Restore Colour files

- User defined grids
- User-defined Components
- Component attribute values editor
- Dynamic drag & drop move
- Change Component for another on-the-fly
- Dimensioning in PCB
- Input & Output to bitmap (and export to Metafile)
- Integrity and Connectivity Checking
- Relative and Absolute design measurements
- Net Optimiser (simplifies manual routing)
- Fast, single button click manufacturing data writer
- Supplied with PDF driver for active PDF output
- Uses Windows drivers for output to all types of printer (Laser jet, Bubble jet, Ink jet, Postscript, PDF)
- Gerber Photo-plotter for RS-274-D and RS-274-X
- Excellon NC Drill output
- ODB++ manufacturing output
- Automatic generation of power ground plane plots
- Plotting of solder mask, silk screen and other special plots
- Plotting to HPGL A and B pen plotter types
- Parts List and Bill of Materials in text and CSV format
- User definable Parts/Net list creation
- Pick and Place assembly outputs
- DXF export (to AutoCAD and other drawing packages)
- DXF import of mechanical data
- Optional IDF output (to mechanical drawing packages)
- Import Formats:
 - Easy-PC (DOS), Pro, Pro-XM (designs and libraries)
 - BoardMaker 1 & 2 format (designs and libraries)
 - Eagle V4.09 to V6.x import (designs and libraries)
 - Ultiboard/UltiCAP format (designs and libraries)
 - OrCAD Native EDIF netlist format to Easy-PC PCB
 - Electronics Workbench netlist format to Easy-PC PCB
- Available in 3 pin variants - 1000, 2000 and unlimited component pins

Cost Options

- Entry level Trace-Router autorouter
- Powerful adaptive strategy Pro-Router autorouter
- Intelligent Gerber Import option
- Gerber Import facility
- GenCAD format PCB export option
- IDF format export to mechanical drawing packages
- IPC-SM surface mount PCB library with over 1,200 footprints
- Pro-library with over 69,600 Components
- Micro controller library with over 9,300 Components
- Connector Library of over 15,900 connectors

Easy-PC Supplementary Options

- Stockit - Stock control and kitting software