

# Datasheet

## Rack Case, 3U

RS Stock number 852-324

### 19" RACK CASES

- Ideal for achieving EMC in 19" systems
- High performance shield (upto 112 dB from 10MHz to 1 GHz)
- Suitable for either 19" racks or cases
- Available in heights of 1U, 2U, 3U and 6U
- Compatible with VERO DIPLOMAT cases (422mm deep)
- Robust easy to assemble construction
- Front panel handles for easy carrying
- Attractive 3mm anodised aluminium front panel
- Friction slide mounting facilities
- Easily customised

### APPLICATIONS

The development of modern electronic systems has led to increasing problems with RFI/EMI interference. Most of these problems can be resolved by good EMC design practice at both board and component level. Some systems are, however, unavoidably sensitive or noisy. As a result of this, and new legislation establishing permitted levels of RFI, enclosures are increasingly being required to provide an effective barrier against this interference.

Careful design of each component has resulted in a range of affordable 19" rack cases, which offer a high degree of Electro-Magnetic Compatibility (EMC).

### MATERIAL SPECIFICATION

Top, base, inner front panel, rear panel side panel  
 Front panel  
 Handle kit  
 Extrusion

: 0,9mm steel with a zinc plate and passivated finish  
 : 3mm anodised aluminium  
 : Moulding,ABS, colour mid grey BS4800 00A05  
 : Anodised aluminium

## VEROSHIELD® - 19" RACK CASES

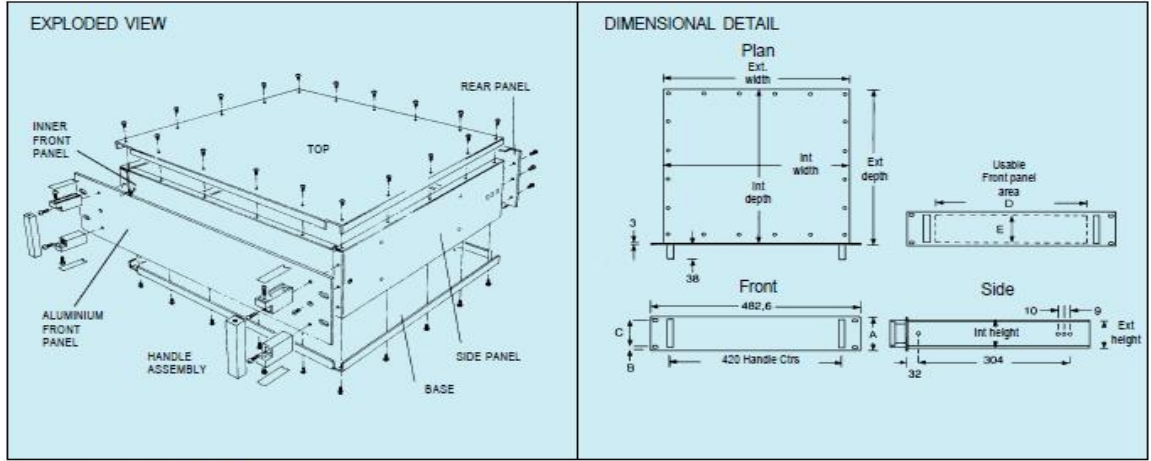

### VEROSHIELD RACK CASES

### Ordering information

Type	External sizes			Internal sizes			Panel sizes					Order code
	Height	Width	Depth	Height	Width	Depth	A	B	C	D	E	
1U x 19"	38,47	438,3	368,5	38,85	434,66	364,86	43,6	5,9	31,8	413,3	22,47	503-63014E
2U x 19"	82,92	438,3	368,5	81,1	434,66	364,86	88,05	5,9	76,25	413,3	66,92	503-63015B
3U x 19"	127,37	438,3	368,5	125,55	434,66	364,86	132,5	37,7	82,78	413,3	111,37	503-63016K
6U x 19"	260,72	438,3	368,5	258,9	434,66	364,86	265,85	37,7	190,45	413,3	244,72	503-63017G