



CABLELINE SOLO



NEW *skirting profile now available*

stylish and versatile trunking

STYLISH AND VERSATILE

MITA are specialists in the manufacture and supply of cable management systems, offering a wide range of single, twin and multi-compartment trunking systems for perimeter and other types of installation.

Where a smaller trunking profile is desired, but capacity is still a requirement, you need **Cableline Solo**. With dimensions of 150x52mm for dado and 175x52mm for skirting, Solo is a three compartment high impact thermoplastic trunking designed to give maximum capacity within a compact profile.

Integral clip-in dividers, which form the three compartments can be removed to form one large single compartment if required.

Clip on fittings aid ease of installation. An optional fixing bracket is available, where screw fixing is a requirement.

As with all other Cableline products, **Solo** is compatible with MITA's range of switch and socket boxes, designed to accept standard wiring accessories from a wide range of leading manufacturers.

3 compartments under one lid - that's **Cableline Solo**.



CA S

THREE COMPARTMENT

TRUNKING ASSEMBLY

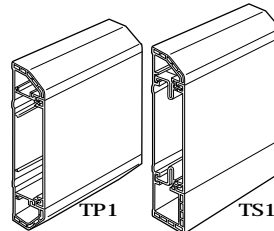

Description	Size	Ref	Packed
Trunking Assembly	150x52mm	TP1	2x3m
	175x52mm	TS1	2x3m

DIVIDERS

Description	Ref	Packed
Spare divider	TPD1	4x1.5m
	TSD1	4x1.5m

FITTINGS

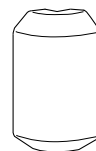

Component	Ref	Packed
External Angle	TPX1	1
	TSX1	1

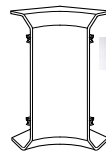

Component	Ref	Packed
Internal Angle	TPI1	1
	TSI1	1



Component	Ref	Packed
End Cap	TPS1	2
	TSS1	2



Component	Ref	Packed
Joint Cover	TPJ1	2
	TSJ1	2

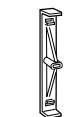

Component	Ref	Packed
Fixing Bracket c/w screws (common to both profiles)	TPFB1	2



Component	Ref	Packed
Cable Retainer	TSCR	10



CABLELINE SOLO

POINTS UNDER ONE LID

colour
ALPINE WHITE

C CLICLINE
Compatible

A fully integrated trunking system can be achieved through the combination of Cableline Solo trunking with Clicline Wiring Accessories.
Flat Tees and Flat Angles (not illustrated) are also available.
See MITA Cable Management Buyers Guide for details.

- *A stylish and compact trunking addition to the Cableline product portfolio*
- *Dividing walls within trunking can be removed to form one large compartment*
- *Dividing walls feature pre-punched cable entry points, for ease of installation*
- *All contained under one single lid*
- *Fittings include External Angle, Internal Angle, End Cap, Joint Cover*
- *Fittings simply clip into place. Optional fixing bracket for screw fixing*
- *Compatible with MITA's standard range of switch and socket boxes*
- *Compatible with MITA's Clicline range of flush mounted wiring accessories*



Cableline Solo complete with Clicline wiring accessories

ACCESSORIES

Components for Solo (common to Cableline Range)

Mini Trunking Adaptors - self adhesive



Ref	Size	Packed
CLA3-1	16 x 16mm	5
CLA3-2	25 x 16mm	5

Cross Over Unit



Ref	Packed
DLO3	1

MCB/RCD Housing

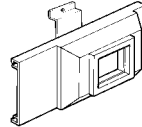

Ref	Packed
DCH3	1

Complete with C/10 DIN mounting rail.
* see page 53 of Mita Perimeter Trunking Catalogue for MCB/RCD suitability

Cable Hanger



Ref	Packed
CLH3	10

Rear Cable Entry Box

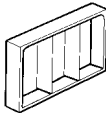

Ref	Packed
CBB3	1

Spacing Cover

Ref	Packed
CCS3	10

Socket Mounting Boxes

Socket Mounting boxes 1 Gang - horizontal

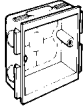

Ref	Depth	Packed
Standard		
CLB3-1	25mm	10
CLB4-1	35mm	10
Screened		
CLBS1	25mm	10
CLBS3	35mm	10

1 Gang - vertical

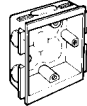

Ref	Depth	Packed
CLB3-1/4	25mm	10
Screened Box = CLBS 1/4		

2 Gang

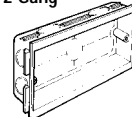

Ref	Depth	Packed
Standard		
CLB3-2	25mm	10
CLB4-2	35mm	10
Screened		
CLBS2	25mm	10
CLBS4	35mm	10

CLICLINE Compatible

A fully integrated trunking system can be achieved through the combination of Cableline Solo trunking with Clicline Wiring Accessories.

Trunking Table

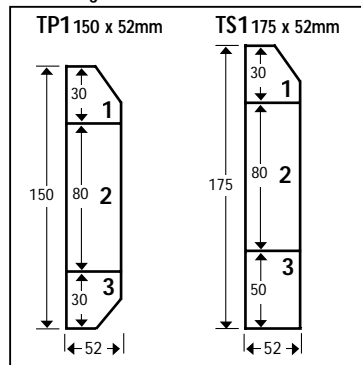

Optional Fixing Brackets for screw fixing

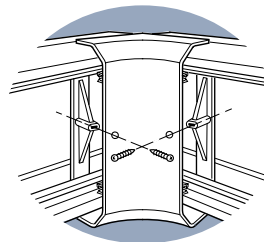

BS EN ISO9002



Bodelwyddan Business Park,
Bodelwyddan, Denbighshire LL18 5SX
United Kingdom

Tel: +44 1745 586000

Fax: +44 1745 586015

e-mail: marketing@mita.co.uk

Visit us at: www.mita.co.uk

All illustrations, drawings and descriptive matter contained in this catalogue or any other of the MITA's publications are intended to be of a general informative nature only and MITA (UK) Limited and its agents or distributors reserve the right to modify, alter designs or change materials and finishes as deemed necessary or desirable. The buyer shall not be entitled to reject goods by reasons of such modifications. Any dimensions given in this brochure are nominal and components of differing sizes may differ in design.

Designed & Printed by Studio 365. Tel: 01352 700365