



DATASHEET

ITEM: 39024CC

WHEEL U 140X50/60 47X17 BB 20+HT GREASE

WHEEL SERIE

Monolithic aluminium wheels, suitable for high temp applications; available with ball bearings.
Wheel fitted with ball bearings.

TECHNICAL DETAILS

Wheel diameter	(D)	140 mm
Tyre width	(E)	50 mm
Bearing seat diameter	(s)	47 mm
Bore diameter	(d)	20 mm
Reference weight		0,88 kg
Hub width	(L)	60 mm
Load capacity		400 kg

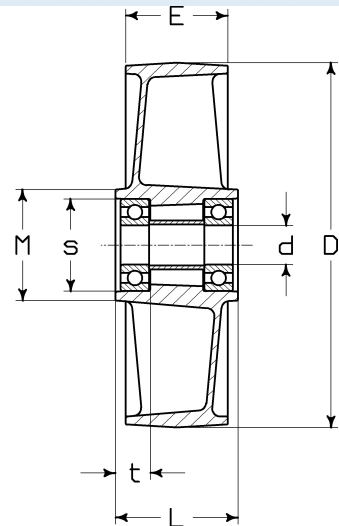
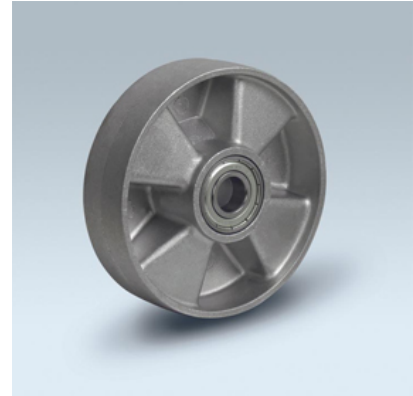

GENERAL INFORMATION / RECOMMENDATIONS AND WARNINGS

The cited text and the complete catalogue in their most up-dated versions are available in our web-site www.lagspa.eu/web/downloads. The dimensions, descriptions, specifications and illustrations herein are indicative and subject to variations without notice. The fact that products are illustrated herein does not necessarily imply they are available from stock nor does it place us under any obligation to supply them. Tests carried out refer to the original products with original accessories: the replacement of one of the components with others of different manufacture might prevent the same results from being achieved and will automatically invalidate any guarantee. Please contact our technical service concerning any special application.