

R75, Film, Metallized Polypropylene, Automotive Grade, 0.22 uF, 5%, 630 VDC, 85°C, Lead Spacing = 22.5mm

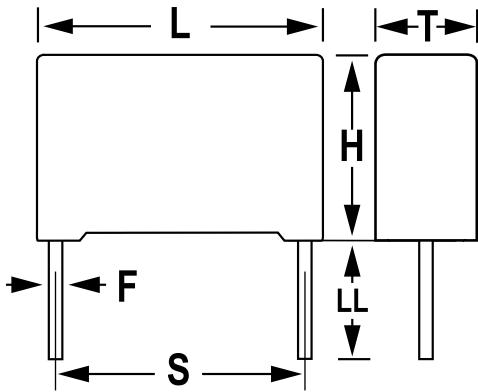

General Information	
Supplier:	KEMET
Series:	R75
Dielectric:	Metallized Polypropylene
Style:	Radial
Features:	Automotive Grade, Pulse
RoHS:	Yes
Lead:	Wire Leads
Qualifications:	AEC-Q200
AEC-Q200:	Yes
Miscellaneous:	Above 85C DC And AC Voltage Derating Is 1.25%/C

Dimensions	
L	26.5mm +0.3mm
H	16mm +0.1mm
T	7mm +0.2mm
S	22.5mm +/-0.4mm
LL	30mm +5mm
F	0.8mm +/-0.05mm

Specifications	
Capacitance:	0.22 uF
Capacitance Tolerance:	5%
Voltage AC:	250 VAC
Voltage DC:	630 VDC
Temperature Range:	-55/+105C
Rated Temperature:	85°C
Dissipation Factor:	0.05% 1kHz, 0.08% 10kHz
Insulation Resistance:	100 GOhms
Max dV/dt:	400 V/us
Inductance:	18 nH

Packaging Specifications	
Packaging:	Bulk, Bag
Packaging Quantity:	500