



WL12G-3B2531

W12G

PHOTOELECTRIC SENSORS

SICK
Sensor Intelligence.



Illustration may differ



Ordering information

Type	Part no.
WL12G-3B2531	1041456

Other models and accessories → www.sick.com/W12G

Detailed technical data

Features

Sensor/ detection principle	Photoelectric retro-reflective sensor, autocollimation
Dimensions (W x H x D)	15.6 mm x 48.5 mm x 42 mm
Housing design (light emission)	Rectangular
Sensing range max.	0 m ... 4 m ¹⁾
Type of light	Visible red light
Light source	LED ²⁾
Light spot size (distance)	Ø 25 mm (1.5 m)
Angle of dispersion	Approx. 1.5°
Wave length	640 nm
Adjustment	Potentiometer, 11 turns
Special applications	Detecting transparent objects

¹⁾ Reflector PL80A.

²⁾ Average service life: 100,000 h at T_J = +25 °C.

Mechanics/electronics

Supply voltage	10 V DC ... 30 V DC ¹⁾
-----------------------	-----------------------------------

¹⁾ Limit values when operated in short-circuit protected network: max. 8 A.

²⁾ May not exceed or fall below U_v tolerances.

³⁾ Without load.

⁴⁾ Signal transit time with resistive load.

⁵⁾ With light/dark ratio 1:1.

⁶⁾ A = V_S connections reverse-polarity protected.

⁷⁾ C = interference suppression.

⁸⁾ D = outputs overcurrent and short-circuit protected.

Ripple	$\leq 5 V_{pp}$ ²⁾
Power consumption	$\leq 30 \text{ mA}$ ³⁾
Switching output	PNP NPN
Switching mode	Light switching Dark switching
Switching mode selector	Selectable via L/D control cable
Signal voltage PNP HIGH/LOW	$> U_v - 3 \text{ V} / \text{ca. } 0 \text{ V}$
Output current I_{max}	100 mA
Response time	$\leq 330 \mu\text{s}$ ⁴⁾
Switching frequency	$\pm 1,500 \text{ Hz}$ ⁵⁾
Connection type	Male connector M12, 5-pin
Circuit protection	A ⁶⁾ C ⁷⁾ D ⁸⁾
Protection class	III
Weight	120 g
Polarisation filter	✓
Housing material	Metal, Zinc diecast
Optics material	Plastic, PMMA
Enclosure rating	IP66 IP67 IP69K
Items supplied	2 x clamps incl. screws
Special feature	Detecting transparent objects
Ambient operating temperature	$-40 \text{ }^\circ\text{C} \dots +60 \text{ }^\circ\text{C}$
Ambient storage temperature	$-40 \text{ }^\circ\text{C} \dots +75 \text{ }^\circ\text{C}$
UL File No.	NRKH.E181493 & NRKH7.E181493

¹⁾ Limit values when operated in short-circuit protected network: max. 8 A.

²⁾ May not exceed or fall below U_v tolerances.

³⁾ Without load.

⁴⁾ Signal transit time with resistive load.

⁵⁾ With light/dark ratio 1:1.

⁶⁾ A = V_S connections reverse-polarity protected.

⁷⁾ C = interference suppression.

⁸⁾ D = outputs overcurrent and short-circuit protected.

Classifications

ECl@ss 5.0	27270902
ECl@ss 5.1.4	27270902
ECl@ss 6.0	27270902
ECl@ss 6.2	27270902
ECl@ss 7.0	27270902
ECl@ss 8.0	27270902
ECl@ss 8.1	27270902

ECl@ss 9.0	27270902
ETIM 5.0	EC002717
ETIM 6.0	EC002717
UNSPSC 16.0901	39121528

Adjustments possible

WL12-3, WSE12-3

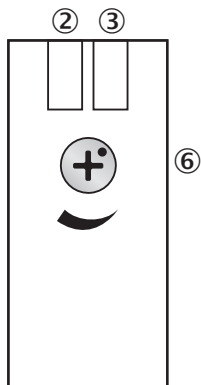

- ② LED indicator yellow: Status of received light beam
- ③ LED indicator green: Supply voltage active
- ⑥ Sensitivity control: potentiometer

Connection diagram

Cd-145

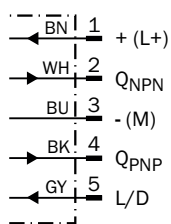

Light spot size

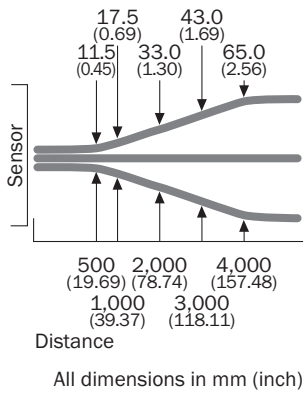

Sensing range diagram

WL12G-3

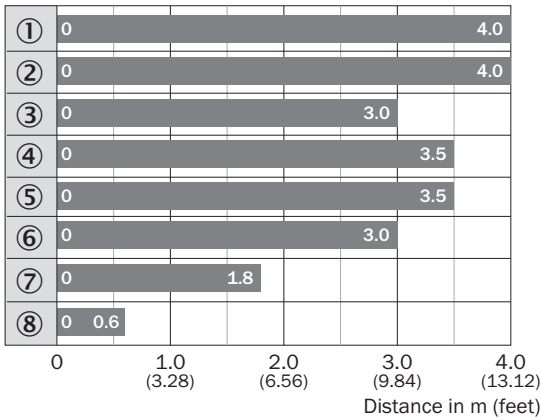

- Sensing range max.
- ① Reflector PL80A
 - ② Reflector C110A
 - ③ Reflector P250F
 - ④ Reflector PL50A
 - ⑤ Reflector PL40A
 - ⑥ Reflector PL30A
 - ⑦ Reflector PL20A
 - ⑧ Reflective tape REF-IRF-56

Dimensional drawing (Dimensions in mm (inch))



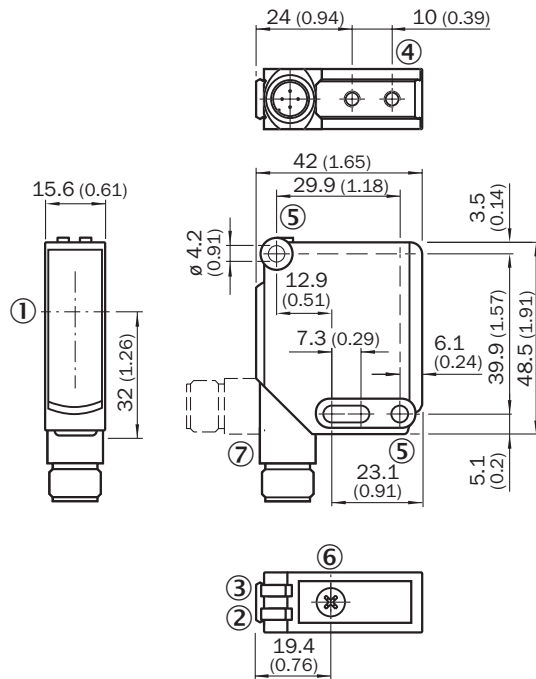

WL12-3, WSE12-3









- ① Optical axis
- ② LED indicator yellow: Status of received light beam
- ③ LED indicator green: Supply voltage active
- ④ M4 threaded mounting hole, 4 mm deep
- ⑤ Mounting hole, \varnothing 4.2 mm
- ⑥ Sensitivity control: potentiometer
- ⑦ Connection

Recommended accessories

Other models and accessories → www.sick.com/W12G

	Brief description	Type	Part no.
Universal bar clamp systems			
	Plate N02 for universal clamp bracket, Zinc plated steel (sheet), Zinc die cast (clamping bracket), Universal clamp (5322626), mounting hardware	BEF-KHS-N02	2051608
	Plate N03 for universal clamp bracket, zinc coated, Zinc plated steel (sheet), Zinc die cast (clamping bracket), Universal clamp (5322626), mounting hardware	BEF-KHS-N03	2051609
	Plate N04 for universal clamp, steel, Zinc plated steel (sheet), Zinc die cast (clamping bracket), Universal clamp (5322626), mounting hardware	BEF-KHS-N04	2051610
Device protection (mechanical)			
	Protective housing for universal clamp, Zinc plated steel (protective housing), Zinc die cast (clamping bracket), Universal clamp, mounting hardware	BEF-SG-W12-3	2045175

	Brief description	Type	Part no.
Mounting brackets and plates			
	Mounting bracket, large, stainless steel, mounting hardware included	BEF-WG-W12	2013942
	Mounting bracket, small, stainless steel, mounting hardware included	BEF-WK-W12	2012938
Terminal and alignment brackets			
	Double clamp bracket for dovetail mounting, Aluminum (anodised), mounting hardware included	BEF-DKH-W12	2013947
	Clamping block for dovetail mounting, Aluminum (anodised), mounting hardware included	BEF-KH-W12	2013285
Plug connectors and cables			
	Head A: female connector, M12, 5-pin, straight, A-coded Head B: Flying leads Cable: Sensor/actuator cable, PVC, unshielded, 5 m	YF2A15-050VB5XLEAX	2096240
	Head A: female connector, M12, 5-pin, angled, A-coded Head B: Flying leads Cable: Sensor/actuator cable, PVC, unshielded, 2 m	YG2A15-020VB5XLEAX	2096215
	Head A: female connector, M12, 5-pin, angled, A-coded Head B: Flying leads Cable: Sensor/actuator cable, PVC, unshielded, 5 m	YG2A15-050VB5XLEAX	2096216
	Head A: female connector, M12, 5-pin, straight Cable: unshielded	DOS-1205-G	6009719
	Head A: female connector, M12, 5-pin, angled Head B: - Cable: unshielded	DOS-1205-W	6009720
Reflectors			
	Rectangular, screw connection, 80 mm x 80 mm, PMMA/ABS, Screw-on, 2 hole mounting	PL80A	1003865
	Fine triple reflector, screw connection, suitable for laser sensors, 47 mm x 47 mm, PMMA/ABS, Screw-on, 2 hole mounting	P250F	5308843
	Fine triple reflector, screw connection, suitable for laser sensors, 18 mm x 18 mm, PMMA/ABS, Screw-on, 2 hole mounting	PL10F	5311210
	Fine triple reflector, screw connection, suitable for laser sensors, 38 mm x 16 mm, PMMA/ABS, Screw-on, 2 hole mounting	PL20F	5308844
	Fine triple reflector, screw connection, suitable for laser sensors, 56 mm x 28 mm, PMMA/ABS, Screw-on, 2 hole mounting	PL30F	5326523
	Fine triple reflector, screw connection, suitable for laser sensors, 76 mm x 45 mm, PMMA/ABS, Screw-on, 2 hole mounting	PL81-1F	5325060

	Brief description	Type	Part no.
	Suitable for laser sensors, self-adhesive, cut, see alignment note, 56.3 mm x 56.3 mm, self-adhesive	REF-AC1000-56	4063030
	Chemically resistant, screw connection, 47 mm x 47 mm, Plastic, Screw-on, 2 hole mounting	P250 CHEM	5321097
	Fine triple reflector, chemically resistant, screw connection, 18 mm x 18 mm, Plastic, Screw-on, 2 hole mounting	PL10F CHEM	5321636
	Chemically resistant, screw connection, suitable for laser sensors, 16 mm x 38 mm, Plastic, Screw-on, 2 hole mounting	PL20F-CHEM	5326089
	Stainless steel reflector, hygienic design, chemically resistant, enclosure rating IP69K, D12 adapter shaft, PMMA front screens, 25 mm x 25 mm, Stainless steel V4A (1.4404, 316L), D12-adapter shaft	PLH25-D12	2063404
	Stainless steel reflector, hygienic design, chemically resistant, Enclosure rating IP 69K, M12-adapter thread, PMMA front screens, 25 mm x 25 mm, Stainless steel V4A (1.4404, 316L), M12-adapter thread	PLH25-M12	2063403
	Stainless steel reflector, washdown design, chemically resistant, IP 69K enclosure rating, screw connection, PMMA front screens, 14 mm x 14 mm, Stainless steel V4A (1.4404, 316L), Screw-on, 2 hole mounting	PLV14-A	2063405

SICK AT A GLANCE

SICK is one of the leading manufacturers of intelligent sensors and sensor solutions for industrial applications. A unique range of products and services creates the perfect basis for controlling processes securely and efficiently, protecting individuals from accidents and preventing damage to the environment.

We have extensive experience in a wide range of industries and understand their processes and requirements. With intelligent sensors, we can deliver exactly what our customers need. In application centers in Europe, Asia and North America, system solutions are tested and optimized in accordance with customer specifications. All this makes us a reliable supplier and development partner.

Comprehensive services complete our offering: SICK LifeTime Services provide support throughout the machine life cycle and ensure safety and productivity.

For us, that is “Sensor Intelligence.”

WORLDWIDE PRESENCE:

Contacts and other locations –www.sick.com