

DATASHEET

ITEM: 39190

WHEEL U 190X50/60 BB FIXED X20

WHEEL SERIE

Monolithic aluminium wheels, suitable for high temp applications; available with ball bearings.

Wheel fitted with ball bearings.

FORK DESCRIPTION

Inox20 series, polished stainless steel forks, swivels with double ball races.

TECHNICAL DETAILS

Wheel diameter	(D)	190 mm
Tyre width	(E)	50 mm
Tyre width	(E)	20 mm
Reference weight		1,195 kg
Overall height	(H)	235 mm
Top plate outer dimensions	(AxB)	135x110 mm
Bolt hole spacing	(axb)	105x75 mm
Bolt hole spacing	(axb)	105x80 mm
Fixing bolt diameter	(g)	10 mm
Fork width	(U)	60 mm
Load capacity		370 kg

Possible options :

Wheel replacement 39040 CC

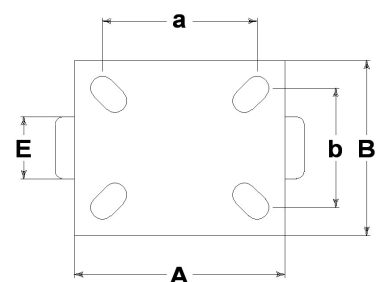
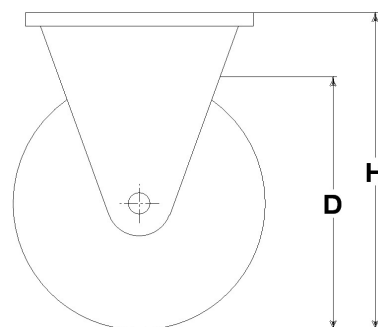

GENERAL INFORMATION / RECOMMENDATIONS AND WARNINGS

The cited text and the complete catalogue in their most up-dated versions are available in our web-site www.lagspa.eu/web/downloads. The dimensions, descriptions, specifications and illustrations herein are indicative and subject to variations without notice. The fact that products are illustrated herein does not necessarily imply they are available from stock nor does it place us under any obligation to supply them. Tests carried out refer to the original products with original accessories: the replacement of one of the components with others of different manufacture might prevent the same results from being achieved and will automatically invalidate any guarantee. Please contact our technical service concerning any special application.