

Power MOSFET

PRODUCT SUMMARY	
V_{DS} (V)	- 250
$R_{DS(on)}$ (Ω)	$V_{GS} = -10$ V 3.0
Q_g (Max.) (nC)	14
Q_{gs} (nC)	3.1
Q_{gd} (nC)	6.8
Configuration	Single

DPAK (TO-252)

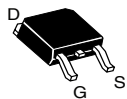

IPAK (TO-251)

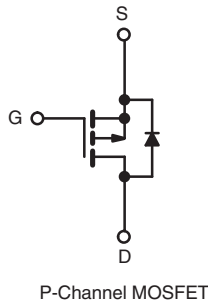
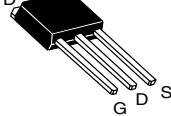

FEATURES

- Halogen-free According to IEC 61249-2-21 Definition
- P-Channel
- Surface Mount (IRFR9214, SiHFR9214)
- Straight Lead (IRFU9214, SiHFU9214)
- Advanced Process Technology
- Fast Switching
- Fully Avalanche Rated
- Compliant to RoHS Directive 2002/95/EC



Available
RoHS*
 COMPLIANT
 HALOGEN
FREE
 Available

DESCRIPTION

Third generation Power MOSFETs from Vishay utilize advanced processing techniques to achieve low on-resistance per silicon area. This benefit, combined with the fast switching speed and ruggedized device design that Power MOSFETs are well known for, provides the designer with an extremely efficient and reliable device for use in a wide variety of applications.

The DPAK is designed for surface mounting using vapor phase, infrared, or wave soldering techniques. The straight lead version (IRFU, SiHFU series) is for through-hole mounting applications. Power dissipation levels up to 1.5 W are possible in typical surface mount applications.

ORDERING INFORMATION				
Package	DPAK (TO-252)	DPAK (TO-252)	DPAK (TO-252)	IPAK (TO-251)
Lead (Pb)-free and Halogen-free	SiHFR9214-GE3	SiHFR9214TRL-GE3	SiHFR9214TR-GE3	SiHFU9214-GE3
Lead (Pb)-free	IRFR9214PbF	IRFR9214TRLPbF ^a	IRFR9214TRPbF ^a	IRFU9214PbF
	SiHFR9214-E3	SiHFR9214TL-E3 ^a	SiHFR9214T-E3 ^a	SiHFU9214-E3
SnPb	IRFR9214	IRFR9214TRL ^a	IRFR9214TR ^a	IRFU9214
	SiHFR9214	SiHFR9214TL ^a	SiHFR9214T ^a	SiHFU9214

Note

a. See device orientation.

ABSOLUTE MAXIMUM RATINGS $T_C = 25^\circ\text{C}$, unless otherwise noted					
PARAMETER			SYMBOL	LIMIT	UNIT
Drain-Source Voltage			V_{DS}	- 250	V
Gate-Source Voltage			V_{GS}	± 20	
Continuous Drain Current	V_{GS} at - 10 V	$T_C = 25^\circ\text{C}$	I_D	- 2.7	A
		$T_C = 100^\circ\text{C}$		- 1.7	
Pulsed Drain Current ^a			I_{DM}	- 11	
Linear Derating Factor				0.40	W/ $^\circ\text{C}$
Single Pulse Avalanche Energy ^b			E_{AS}	100	mJ
Repetitive Avalanche Current ^a			I_{AR}	- 2.7	A
Repetitive Avalanche Energy ^a			E_{AR}	5.0	mJ
Maximum Power Dissipation	$T_C = 25^\circ\text{C}$		P_D	50	W
Peak Diode Recovery dV/dt^c			dV/dt	- 5.0	V/ns
Operating Junction and Storage Temperature Range			T_J, T_{stg}	- 55 to + 150	$^\circ\text{C}$
Soldering Recommendations (Peak Temperature)	for 10 s			260 ^d	

Notes



- Repetitive rating; pulse width limited by maximum junction temperature (see fig. 11).
- Starting $T_J = 25^\circ\text{C}$, $L = 27$ mH, $R_g = 25 \Omega$, $I_{AS} = - 2.7$ A (see fig. 12).
- $I_{SD} \leq - 2.7$ A, $dI/dt \leq 600$ A/ μs , $V_{DD} \leq V_{DS}$, $T_J \leq 150^\circ\text{C}$.
- 1.6 mm from case.

* Pb containing terminations are not RoHS compliant, exemptions may apply

THERMAL RESISTANCE RATINGS						
PARAMETER	SYMBOL	MIN.	TYP.	MAX.	UNIT	
Maximum Junction-to-Ambient	R_{thJA}	-	-	110	°C/W	
Maximum Junction-to-Ambient (PCB Mount) ^a	R_{thJA}	-	-	50		
Maximum Junction-to-Case (Drain)	R_{thJC}	-	-	2.5		

Note

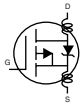
a. When mounted on 1" square PCB (FR-4 or G-10 material).

SPECIFICATIONS $T_J = 25\text{ }^\circ\text{C}$, unless otherwise noted							
PARAMETER	SYMBOL	TEST CONDITIONS		MIN.	TYP.	MAX.	UNIT
Static							
Drain-Source Breakdown Voltage	V_{DS}	$V_{GS} = 0\text{ V}, I_D = -250\text{ }\mu\text{A}$		-250	-	-	V
V_{DS} Temperature Coefficient	$\Delta V_{DS}/T_J$	Reference to $25\text{ }^\circ\text{C}$, $I_D = -1\text{ mA}$		-	-0.25	-	V/°C
Gate-Source Threshold Voltage	$V_{GS(th)}$	$V_{DS} = V_{GS}, I_D = -250\text{ }\mu\text{A}$		-2.0	-	-4.0	V
Gate-Source Leakage	I_{GSS}	$V_{GS} = \pm 20\text{ V}$		-	-	± 100	nA
Zero Gate Voltage Drain Current	I_{DSS}	$V_{DS} = -250\text{ V}, V_{GS} = 0\text{ V}$		-	-	-100	μA
		$V_{DS} = -200\text{ V}, V_{GS} = 0\text{ V}, T_J = 125\text{ }^\circ\text{C}$		-	-	-500	
Drain-Source On-State Resistance	$R_{DS(on)}$	$V_{GS} = -10\text{ V}$	$I_D = -1.7\text{ A}^b$	-	-	3.0	Ω
Forward Transconductance	g_{fs}	$V_{DS} = -50\text{ V}, I_D = -1.7\text{ A}$		0.9	-	-	S
Dynamic							
Input Capacitance	C_{iss}	$V_{GS} = 0\text{ V}, V_{DS} = -25\text{ V}, f = 1.0\text{ MHz}$, see fig. 5		-	220	-	pF
Output Capacitance	C_{oss}			-	75	-	
Reverse Transfer Capacitance	C_{rss}			-	11	-	
Total Gate Charge	Q_g	$V_{GS} = -10\text{ V}$	$I_D = -1.7\text{ A}, V_{DS} = -200\text{ V}$, see fig. 6 and 13 ^b	-	-	14	nC
Gate-Source Charge	Q_{gs}			-	-	3.1	
Gate-Drain Charge	Q_{gd}			-	-	6.8	
Turn-On Delay Time	$t_{d(on)}$	$V_{DD} = -125\text{ V}, I_D = -1.7\text{ A}, R_g = 21\text{ }\Omega, R_D = 70\text{ }\Omega$, see fig. 10 ^b		-	11	-	ns
Rise Time	t_r			-	14	-	
Turn-Off Delay Time	$t_{d(off)}$			-	20	-	
Fall Time	t_f			-	17	-	
Internal Drain Inductance	L_D	Between lead, 6 mm (0.25") from package and center of die contact 		-	4.5	-	nH
Internal Source Inductance	L_S			-	7.5	-	
Drain-Source Body Diode Characteristics							
Continuous Source-Drain Diode Current	I_S	MOSFET symbol showing the integral reverse p - n junction diode 		-	-	-2.7	A
Pulsed Diode Forward Current ^a	I_{SM}			-	-	-11	
Body Diode Voltage	V_{SD}	$T_J = 25\text{ }^\circ\text{C}, I_S = -2.7\text{ A}, V_{GS} = 0\text{ V}^b$		-	-	-5.8	V
Body Diode Reverse Recovery Time	t_{rr}	$T_J = 25\text{ }^\circ\text{C}, I_F = -1.7\text{ A}, di/dt = 100\text{ A}/\mu\text{s}^b$		-	150	220	ns
Body Diode Reverse Recovery Charge	Q_{rr}			-	870	1300	nC
Forward Turn-On Time	t_{on}	Intrinsic turn-on time is negligible (turn-on is dominated by L_S and L_D)					

Notes

- a. Repetitive rating; pulse width limited by maximum junction temperature (see fig. 11).
- b. Pulse width $\leq 300\text{ }\mu\text{s}$; duty cycle $\leq 2\%$.

TYPICAL CHARACTERISTICS 25 °C, unless otherwise noted

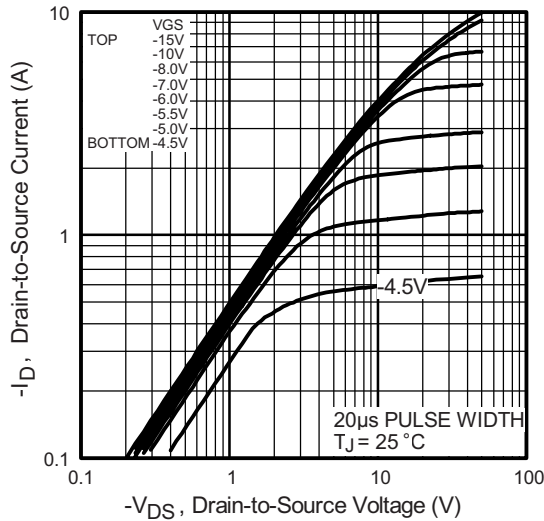

Fig. 1 - Typical Output Characteristics, $T_C = 25\text{ }^\circ\text{C}$

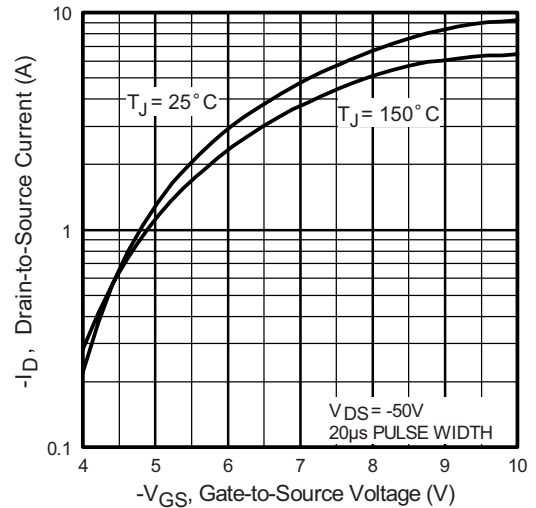

Fig. 3 - Typical Transfer Characteristics

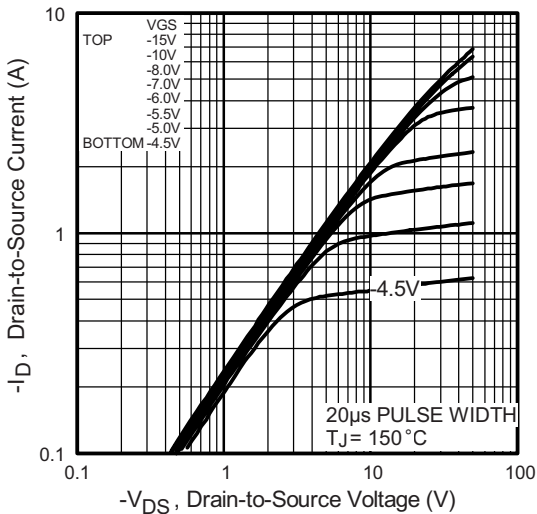

Fig. 2 - Typical Output Characteristics, $T_C = 150\text{ }^\circ\text{C}$

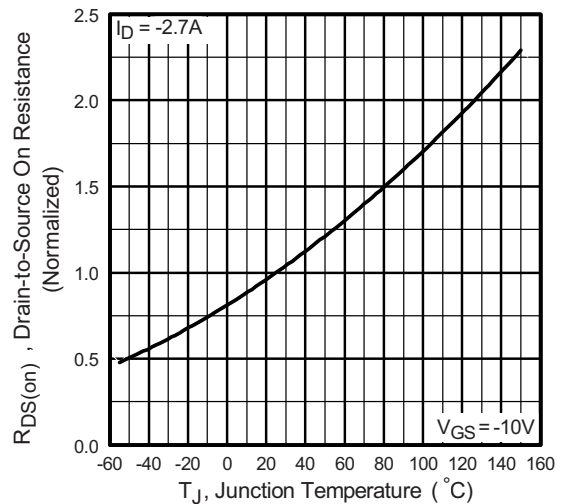

Fig. 4 - Normalized On-Resistance vs. Temperature

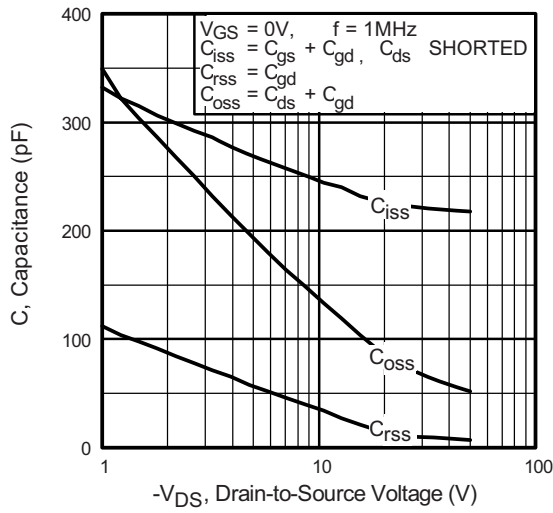

Fig. 5 - Typical Capacitance vs. Drain-to-Source Voltage

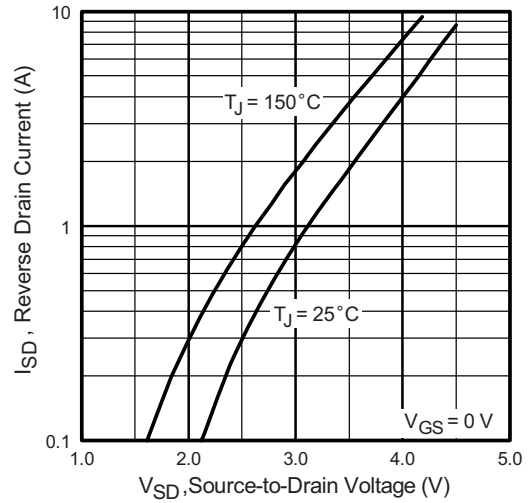

Fig. 7 - Typical Source-Drain Diode Forward Voltage

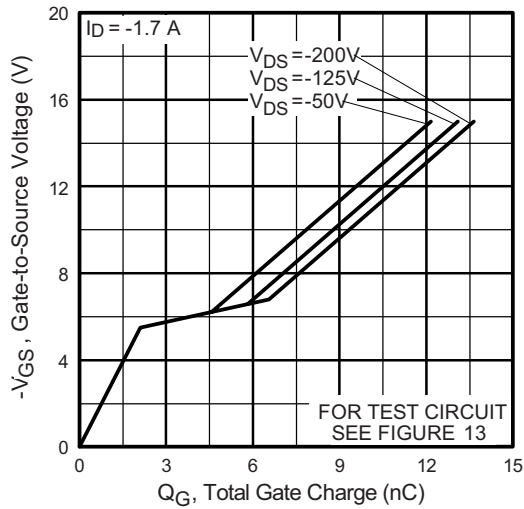

Fig. 6 - Typical Gate Charge vs. Gate-to-Source Voltage

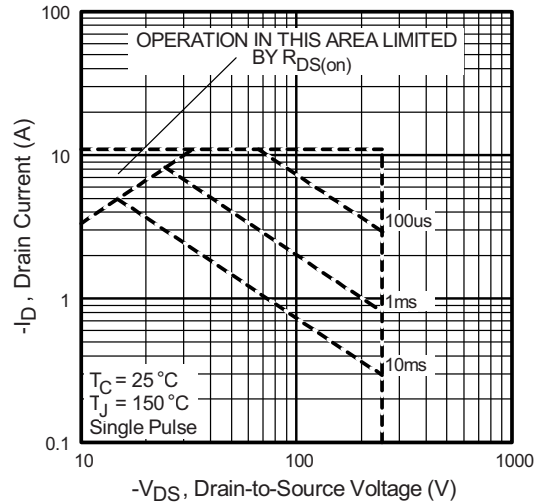

Fig. 8 - Maximum Safe Operating Area

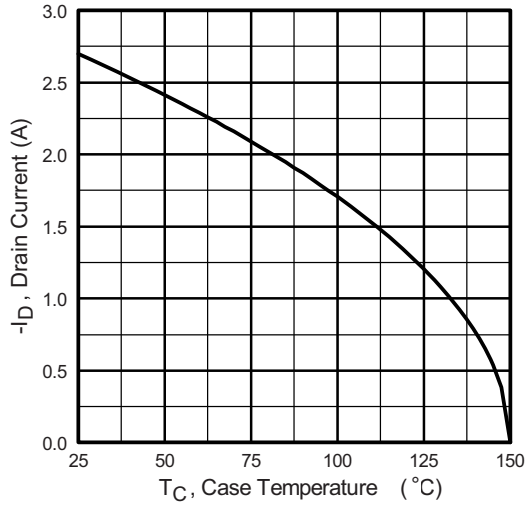

Fig. 9 - Maximum Drain Current vs. Case Temperature

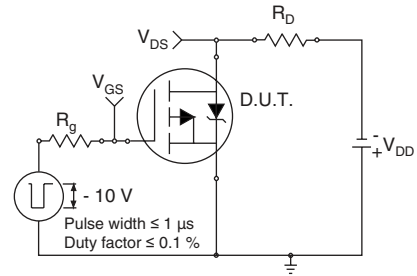

Fig. 10a - Switching Time Test Circuit

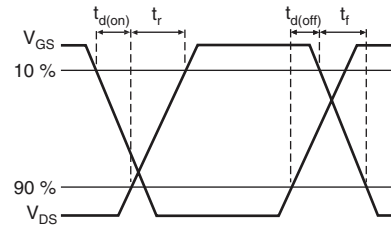

Fig. 10b - Switching Time Waveforms

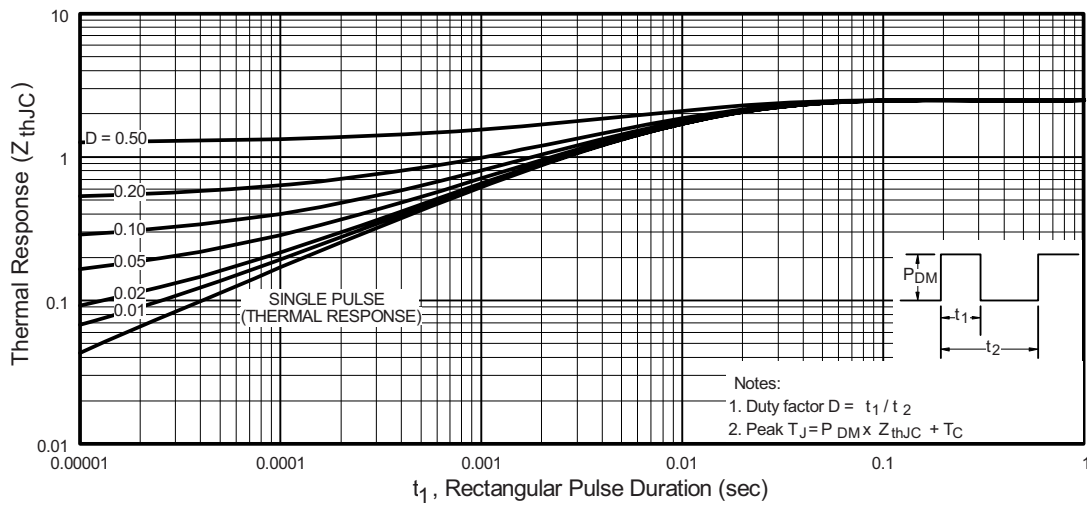

Fig. 11 - Maximum Effective Transient Thermal Impedance, Junction-to-Case

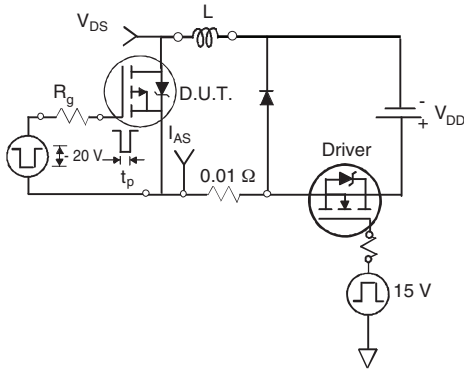

Fig. 12a - Unclamped Inductive Test Circuit

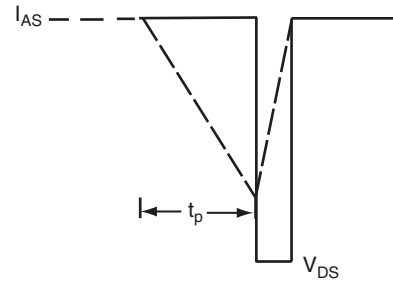

Fig. 12b - Unclamped Inductive Waveforms

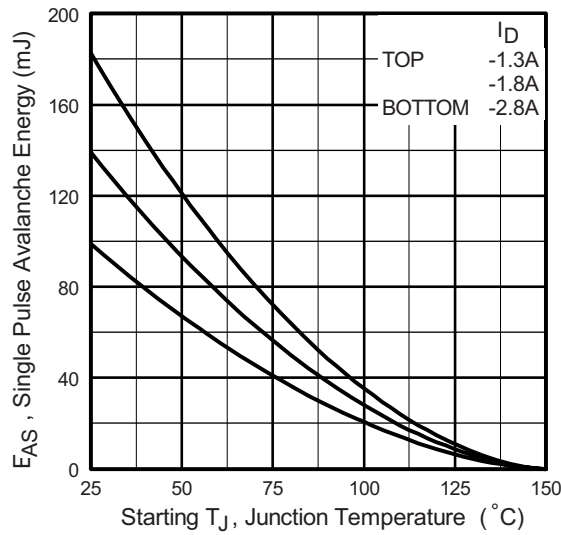

Fig. 12c - Maximum Avalanche Energy vs. Drain Current

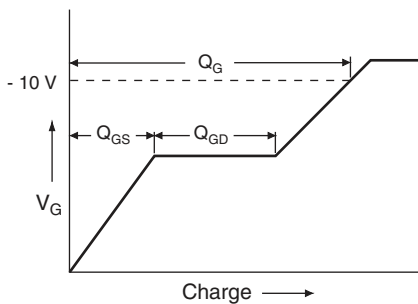

Fig. 13a - Basic Gate Charge Waveform

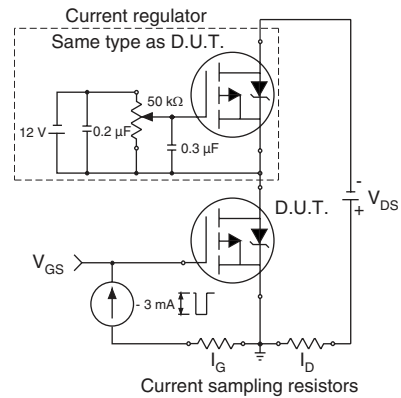
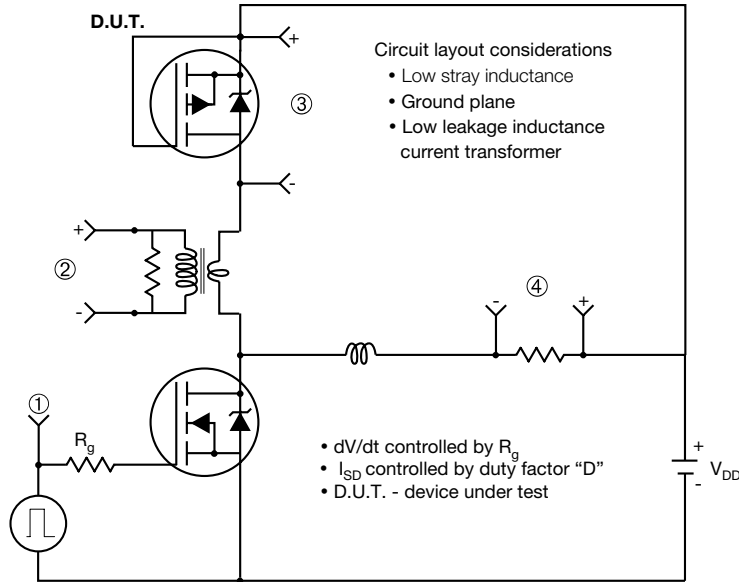
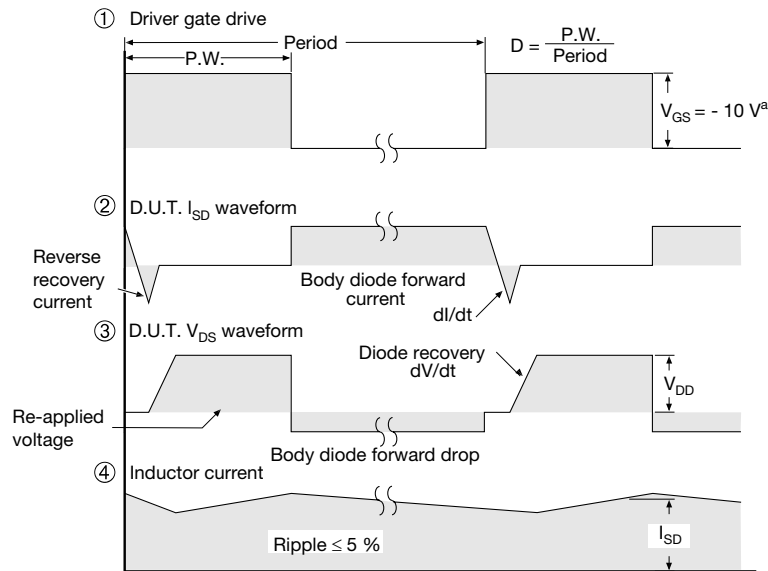

Fig. 13b - Gate Charge Test Circuit

Peak Diode Recovery dV/dt Test Circuit



Note
• Compliment N-Channel of D.U.T. for driver



Note
a. $V_{GS} = -5\text{ V}$ for logic level and -3 V drive devices

Fig. 14 - For P-Channel

Vishay Siliconix maintains worldwide manufacturing capability. Products may be manufactured at one of several qualified locations. Reliability data for Silicon Technology and Package Reliability represent a composite of all qualified locations. For related documents such as package/tape drawings, part marking, and reliability data, see www.vishay.com/ppg291282.



Disclaimer

ALL PRODUCT, PRODUCT SPECIFICATIONS AND DATA ARE SUBJECT TO CHANGE WITHOUT NOTICE TO IMPROVE RELIABILITY, FUNCTION OR DESIGN OR OTHERWISE.

Vishay Intertechnology, Inc., its affiliates, agents, and employees, and all persons acting on its or their behalf (collectively, "Vishay"), disclaim any and all liability for any errors, inaccuracies or incompleteness contained in any datasheet or in any other disclosure relating to any product.

Vishay makes no warranty, representation or guarantee regarding the suitability of the products for any particular purpose or the continuing production of any product. To the maximum extent permitted by applicable law, Vishay disclaims (i) any and all liability arising out of the application or use of any product, (ii) any and all liability, including without limitation special, consequential or incidental damages, and (iii) any and all implied warranties, including warranties of fitness for particular purpose, non-infringement and merchantability.

Statements regarding the suitability of products for certain types of applications are based on Vishay's knowledge of typical requirements that are often placed on Vishay products in generic applications. Such statements are not binding statements about the suitability of products for a particular application. It is the customer's responsibility to validate that a particular product with the properties described in the product specification is suitable for use in a particular application. Parameters provided in datasheets and/or specifications may vary in different applications and performance may vary over time. All operating parameters, including typical parameters, must be validated for each customer application by the customer's technical experts. Product specifications do not expand or otherwise modify Vishay's terms and conditions of purchase, including but not limited to the warranty expressed therein.

Except as expressly indicated in writing, Vishay products are not designed for use in medical, life-saving, or life-sustaining applications or for any other application in which the failure of the Vishay product could result in personal injury or death. Customers using or selling Vishay products not expressly indicated for use in such applications do so at their own risk and agree to fully indemnify and hold Vishay and its distributors harmless from and against any and all claims, liabilities, expenses and damages arising or resulting in connection with such use or sale, including attorneys fees, even if such claim alleges that Vishay or its distributor was negligent regarding the design or manufacture of the part. Please contact authorized Vishay personnel to obtain written terms and conditions regarding products designed for such applications.

No license, express or implied, by estoppel or otherwise, to any intellectual property rights is granted by this document or by any conduct of Vishay. Product names and markings noted herein may be trademarks of their respective owners.