

KEMET Part Number: LDBAA2150GC5N0
(DBAA2150GC5N0)

LDB, Film, Metallized PPS Stacked, General Purpose, 0.015 uF, 2%, 16 VDC, 125°C, 1206, 1.1mm

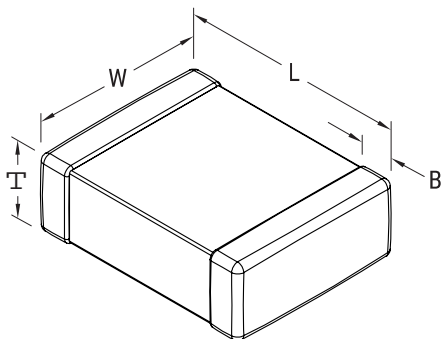

Dimensions	
Chip Size	1206
L	3.3mm +0.3/-0.1mm
W	1.7mm +/-0.2mm
T	1.1mm MAX
B	0.5mm +0.5/-0.3mm

Packaging Specifications	
Packaging:	T&R
Packaging Quantity:	3000

General Information	
Supplier:	KEMET
Series:	LDB
Dielectric:	Metallized PPS Stacked
Style:	SMD Chip
RoHS:	Yes
Shelf Life:	104 Weeks
MSL:	3

Specifications	
Capacitance:	0.015 uF
Capacitance Tolerance:	2%
Voltage DC:	16 VDC
Temperature Range:	-55/+125C
Rated Temperature:	125°C
Dissipation Factor:	0.60% 1kHz
Insulation Resistance:	3 GOhms