

PRELIMINARY SPEC

Part Number: SC39-11PBWA

BLUE



**ATTENTION**  
OBSERVE PRECAUTIONS  
FOR HANDLING  
ELECTROSTATIC  
DISCHARGE  
SENSITIVE  
DEVICES

### Features

- 0.39 INCH DIGIT HEIGHT.
- LOW CURRENT OPERATION.
- EXCELLENT CHARACTER APPEARANCE.
- EASY MOUNTING ON P.C. BOARDS OR SOCKETS.
- I.C. COMPATIBLE.
- MECHANICALLY RUGGED.
- STANDARD : GRAY FACE, WHITE SEGMENT.
- RoHS COMPLIANT.

### Description

The Blue source color devices are made with InGaN on SiC Light Emitting Diode.  
Static electricity and surge damage the LEDs.  
It is recommended to use a wrist band or anti-electrostatic glove when handling the LEDs.  
All devices, equipment and machinery must be electrically grounded.

### Package Dimensions & Internal Circuit Diagram

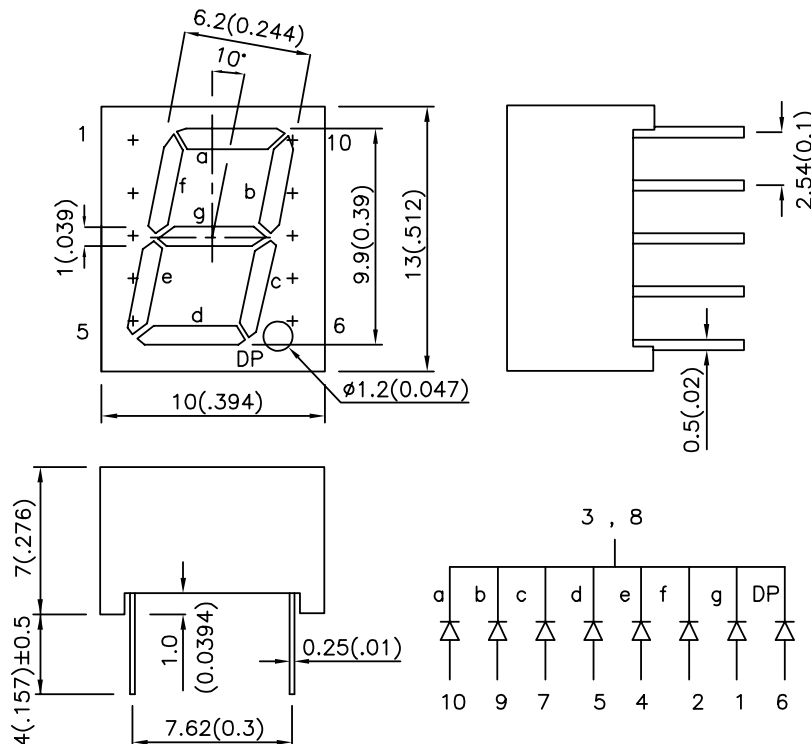

Notes:

1. All dimensions are in millimeters (inches), Tolerance is  $\pm 0.25(0.01)$  unless otherwise noted.
2. Specifications are subject to change without notice.



## Selection Guide

Part No.	Dice	Lens Type	Iv (ucd) [1] @ 10mA		Description
			Min.	Typ.	
SC39-11PBWA	BLUE (InGaN)	WHITE DIFFUSED	3000	7800	Common Cathode, Rt. Hand Decimal.

Notes:

1. Luminous Intensity / Luminous Flux: +/-15%.

## Electrical / Optical Characteristics at TA=25°C

Symbol	Parameter	Device	Typ.	Max.	Units	Test Conditions
$\lambda_{peak}$	Peak Wavelength	Blue	468		nm	IF=20mA
$\lambda_D$ [1]	Dominant Wavelength	Blue	470		nm	IF=20mA
$\Delta\lambda_{1/2}$	Spectral Line Half-width	Blue	21		nm	IF=20mA
C	Capacitance	Blue	100		pF	VF=0V;f=1MHz
VF [2]	Forward Voltage	Blue	3.2	4.0	V	IF=20mA
IR	Reverse Current	Blue		10	uA	VR = 5V

Notes:

1. Wavelength: +/-1nm.

2. Forward Voltage: +/-0.1V.

## Absolute Maximum Ratings at TA=25°C

Parameter	Blue	Units
Power dissipation	120	mW
DC Forward Current	30	mA
Peak Forward Current [1]	100	mA
Reverse Voltage	5	V
Operating/Storage Temperature	-40°C To +85°C	
Lead Solder Temperature [2]	260°C For 3-5 Seconds	

Notes:

1. 1/10 Duty Cycle, 0.1ms Pulse Width.

2. 2mm below package base.

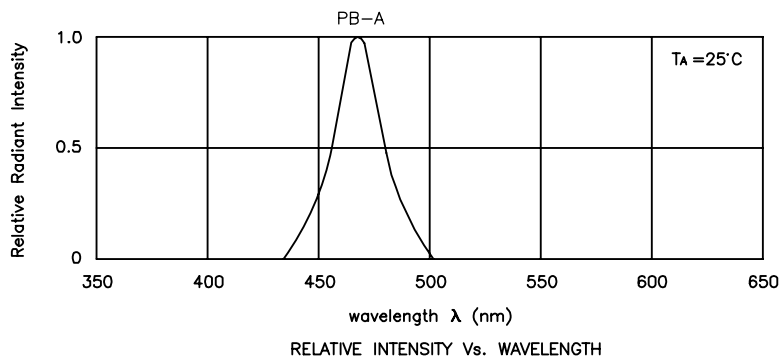

Blue

SC39-11PBWA

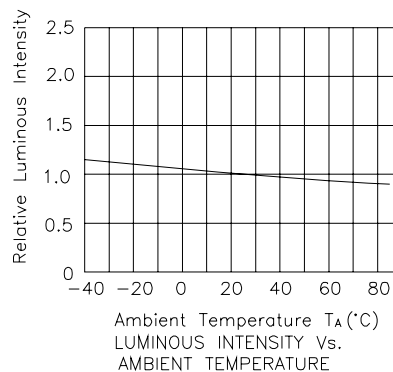
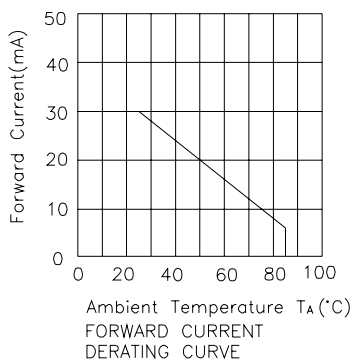
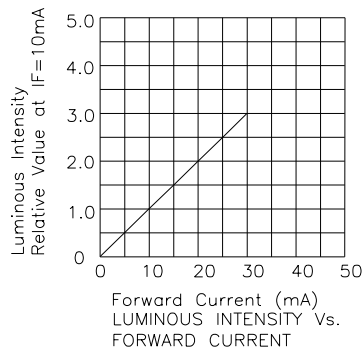
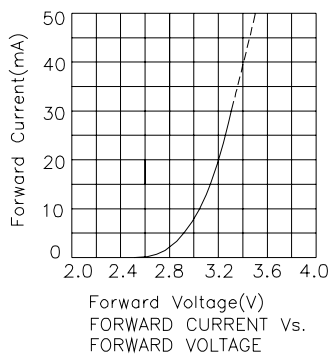

## PACKING & LABEL SPECIFICATIONS

## SC39-11PBWA

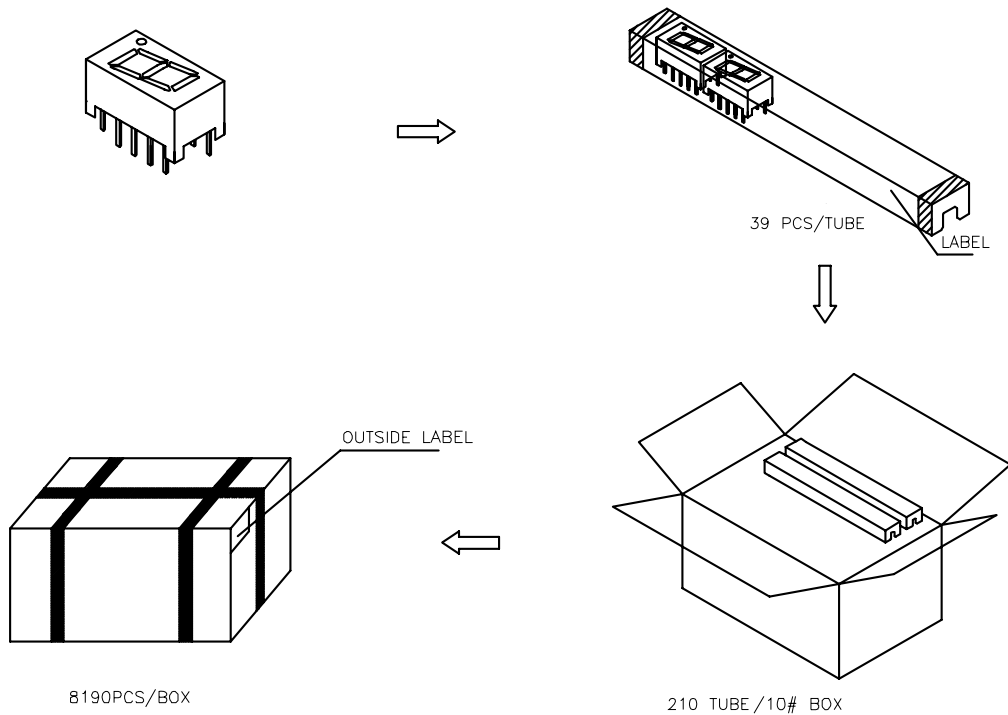

Inside LABEL Paste On The IC-tube

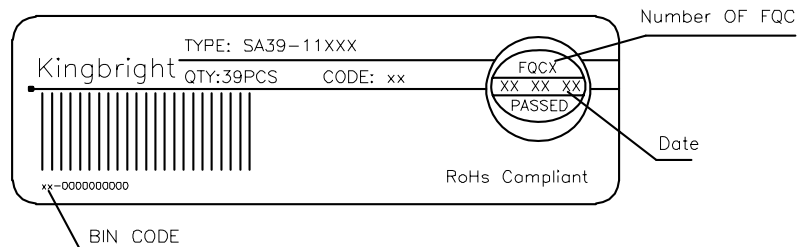

Outside LABEL Paste On The Box

