

Datasheet

Blue Surface Mount Female 2P+E Industrial Power Socket Rated At 16A,200 → 250 V

RS Stock number [781-2702](#)



Specifications:

Rated Current:	16A – 32A
Rated Voltage:	100÷690V~
Frequency:	d.c - 50÷500Hz
Insulation Voltage:	500/690V~
Protection Degree:	Base and top: IP44 – IP66/IP67 Combi: IP44 closed cover
Operating temperature according to the reference standard:	-25°C + 40°C
Max. Operating Temperature:	60°C
Glow Wire Test:	650°C/850°C
Material:	Engineering plastic
IK Degree at 20°C:	IK08
Cable Inlets:	Cable sleeve IP44 Cable gland IP66/IP67
Halogen Free:	Yes
Terminals:	Screw (16A-32A) Spring (32A)
Safe-in Device:	16A
Fuses:	Max 10A – 5x20mm
(COMBI version)	H: high power cutoff (1500A) T: delayed action

TOP VERSION - IP44

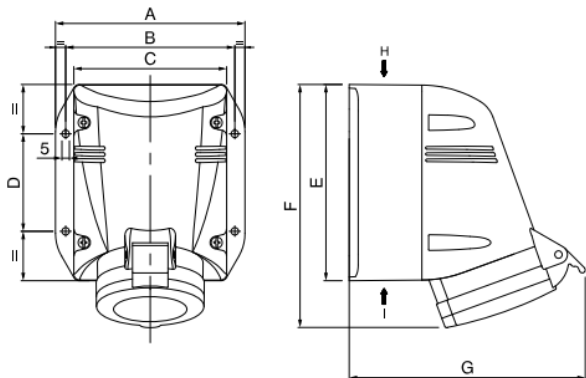

	A	B	C	D	E	F	G	H	I
2P+E	94	80	70	/	96	126	119	M20X1.5	M20X1.5
16A 3P+E	109	97	85	51	112	140	140	M25X1.5	2X M25X1.5
3P+N+E	109	97	85	51	112	143	141	M25X1.5	2X M25X1.5
2P+E	126	113	102	65	130	159	156	M32X1.5	2X M32X1.5
32A 3P+E	126	113	102	65	130	159	156	M32X1.5	2X M32X1.5
3P+N+E	126	113	102	65	130	162	158	M32X1.5	2X M32X1.5

TOP VERSION - IP66/IP67

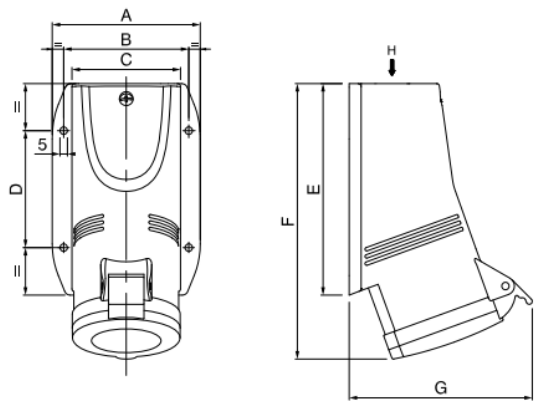

	A	B	C	D	E	F	G	H	I
2P+E	94	80	70	/	96	131	110	M20X1.5	M20X1.5
16A 3P+E	109	97	85	51	112	146	134	M25X1.5	2X M25X1.5
3P+N+E	109	97	85	51	112	150	135	M25X1.5	2X M25X1.5
2P+E	126	113	102	65	130	166	151	M32X1.5	2X M32X1.5
32A 3P+E	126	113	102	65	130	166	151	M32X1.5	2X M32X1.5
3P+N+E	126	113	102	65	130	167	152	M32X1.5	2X M32X1.5

BASE VERSION - IP44

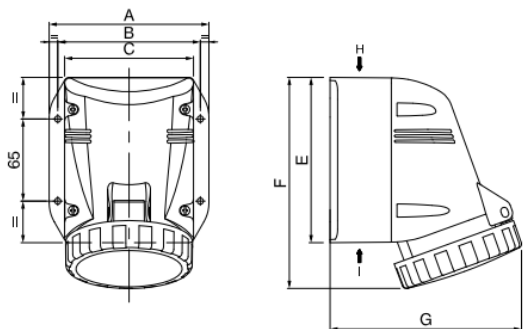

	A	B	C	D	E	F	G	H
2P+E	76	63	52	/	103	133	98	M20X1.5
16A 3P+E	91	76	65	60	123	155	103	M25X1.5
3P+N+E	91	76	65	60	123	157	110	M25X1.5
2P+E	99	84	72	78	141	182	115	M32X1.5
32A 3P+E	99	84	72	78	141	182	115	M32X1.5
3P+N+E	99	84	72	78	141	184	122	M32X1.5

COMBI VERSION - IP44

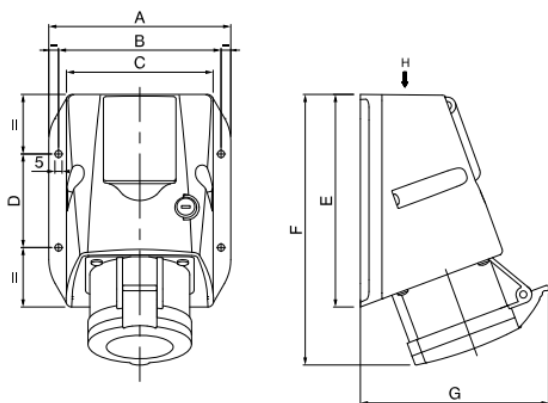

	A	B	C	D	E	F	G	H
2P+E	126	113	102	65	148	188	131	M32X1.5
16A 3P+E	126	113	102	65	148	188	131	M32X1.5
3P+N+E	126	113	102	65	148	188	131	M32X1.5
2P+E	126	113	102	65	148	188	131	M32X1.5
32A 3P+E	126	113	102	65	148	188	131	M32X1.5
3P+N+E	126	113	102	65	148	188	131	M32X1.5

(Dimension in mm)