

**Ordering number C13012\_FLARE-MAXI-D**

Family	Flare	FWHM	12+104 degrees
Type	Lens	Efficiency	94 %
LED	LUXEON A	cd/lm	2.100
Color	Clear	Gerber File	Available
Diameter	33.9 + 33.3 mm		
Height	16.7 mm		
Style	Rectang		
Optic Material	PMMA		
Holder Material	-		
Fastening	Pin, glue		
Status	Ready		

**Ordering number C13015\_FLARE-MINI-AD**

Family	Flare	FWHM	92+20 degrees
Type	Lens	Efficiency	94 %
LED	LUXEON A	cd/lm	1.100
Color	Clear	Gerber File	Available
Diameter	16 mm		
Height	8.6 mm		
Style	Round		
Optic Material	PMMA		
Holder Material	-		
Fastening	Glue		
Status	Ready		

**Ordering number C13016\_FLARE-MINI-AD-PIN**

Family	Flare	FWHM	92+20 degrees
Type	Lens	Efficiency	94 %
LED	LUXEON A	cd/lm	1.100
Color	Clear	Gerber File	Available
Diameter	16 mm		
Height	8.6 mm		
Style	Round		
Optic Material	PMMA		
Holder Material	-		
Fastening	Pin, glue		
Status	Ready		

**Ordering number CA13057\_FLARE-MINI-AD**

Family	Flare	FWHM	92+20 degrees
Type	Assembly	Efficiency	94 %
LED	LUXEON A	cd/lm	1.100
Color	Clear	Gerber File	Available
Diameter	16 mm		
Height	9.1 mm		
Style	Round		
Optic Material	PMMA		
Holder Material	-		
Fastening	Tape		
Status	Ready		

**Ordering number CA13058\_FLARE-MINI-AD-PIN**

Family	Flare	FWHM	92+20 degrees
Type	Assembly	Efficiency	94 %
LED	LUXEON A	cd/lm	1.100
Color	Clear	Gerber File	Available
Diameter	16 mm		
Height	9.1 mm		
Style	Round		
Optic Material	PMMA		
Holder Material	-		
Fastening	Pin, tape		
Status	Ready		

**NOTE: The typical divergence will be changed by different color, chip size and chip position tolerance. The typical total divergence is the full angle measured where the luminous intensity is half of the peak value.**



## PRODUCT DATASHEET

### Flare series

last update 16/11/2012

PHILIPS  
LUMILEDS

#### GENERAL INFORMATION

- Product series especially designed & optimized for LUXEON A series of LEDs.
- Special care taken to make light distribution as uniform as possible.
- Lens material optical grade PMMA with high UV and temperature resistance. Allows use of high current and temperature conditions.

Please find more information about used material from below:

[http://ledil.fi/sites/default/files/Documents/Technical/Material/PMMA%20N%20UL94\\_Yellow%20Card.pdf](http://ledil.fi/sites/default/files/Documents/Technical/Material/PMMA%20N%20UL94_Yellow%20Card.pdf)

<http://ledil.fi/sites/default/files/Documents/Technical/Material/PMMA%20N%20PLEXIGLAS-Datasheet.pdf>

Relative intensity of CA13057&CA13058\_FLARE-MINI-AD-LuxA

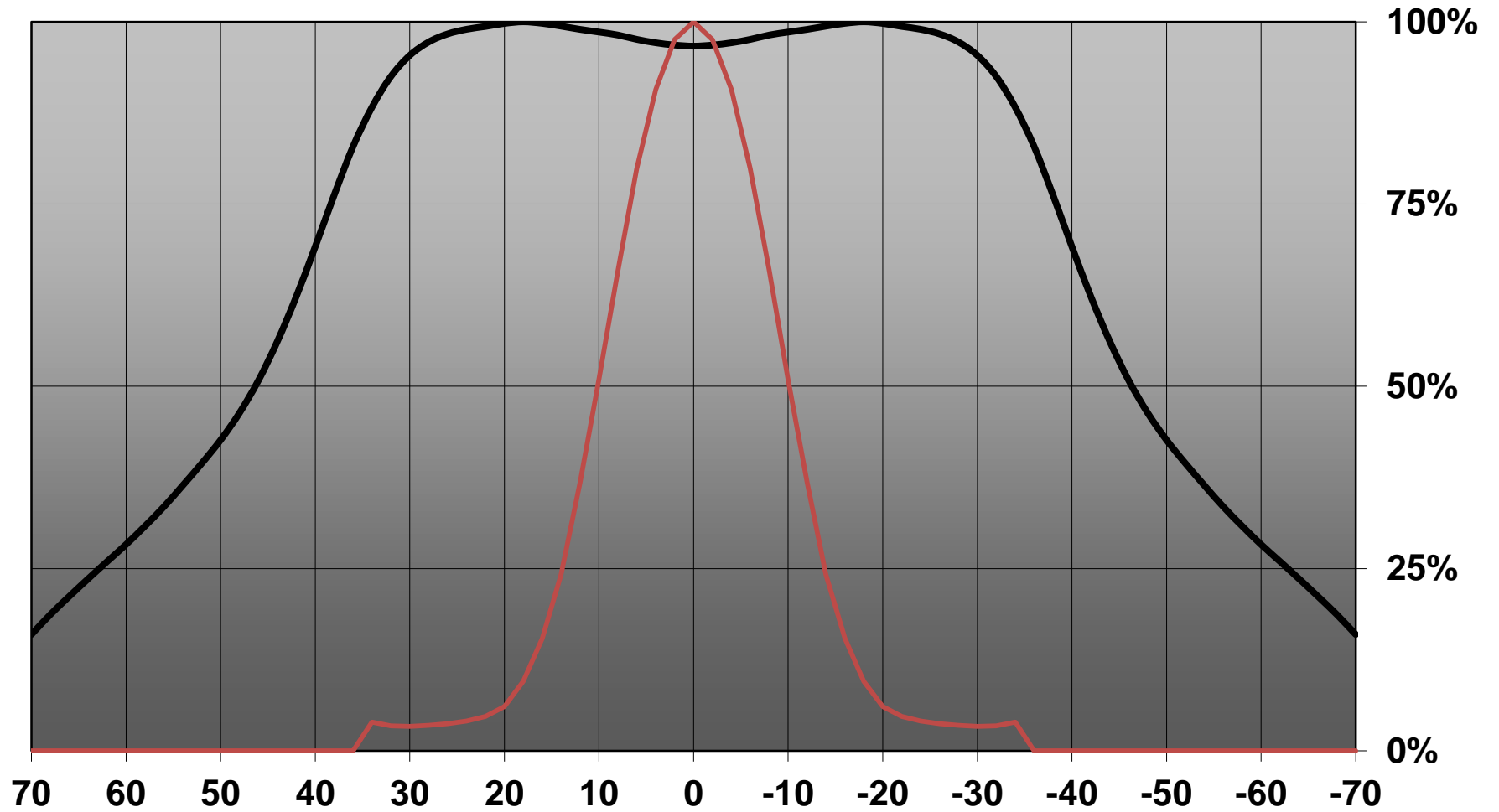

Relative intensity of CA13057&CA13058\_FLARE-MINI-AD-LuxA

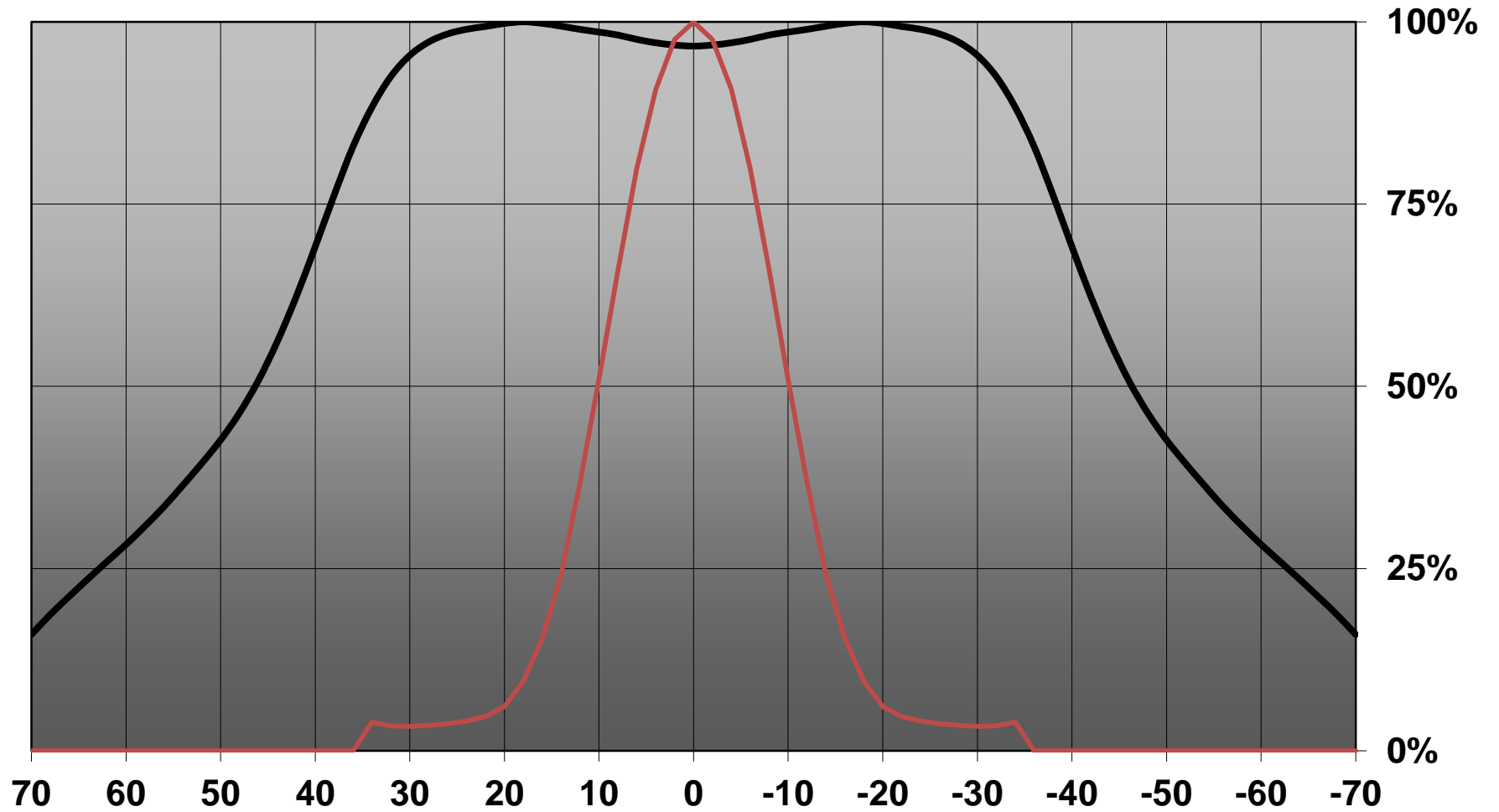

Relative intensity of CA13057&CA13058\_FLARE-MINI-AD-LuxA

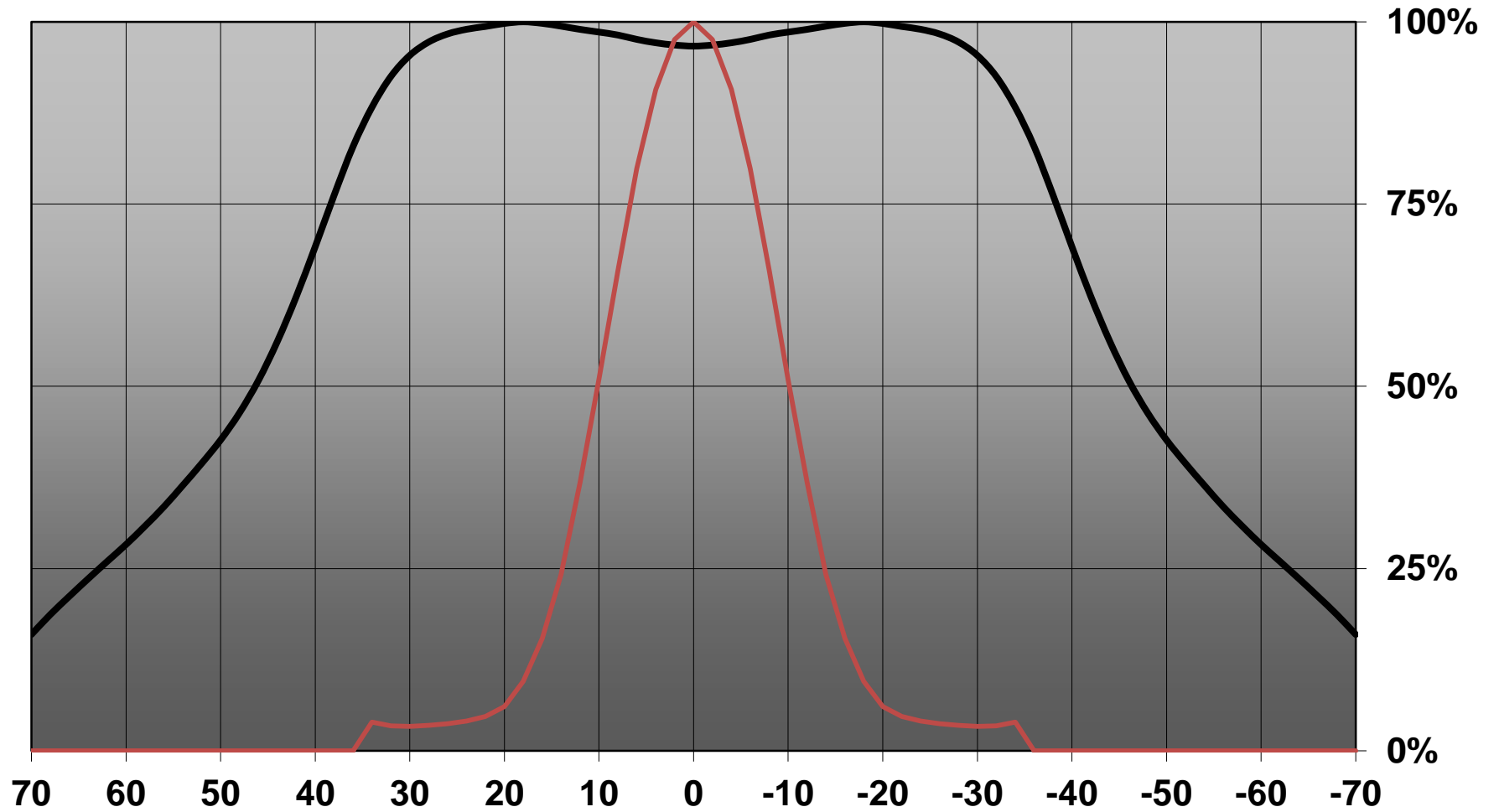

Relative intensity of CA13057&CA13058\_FLARE-MINI-AD-LuxA

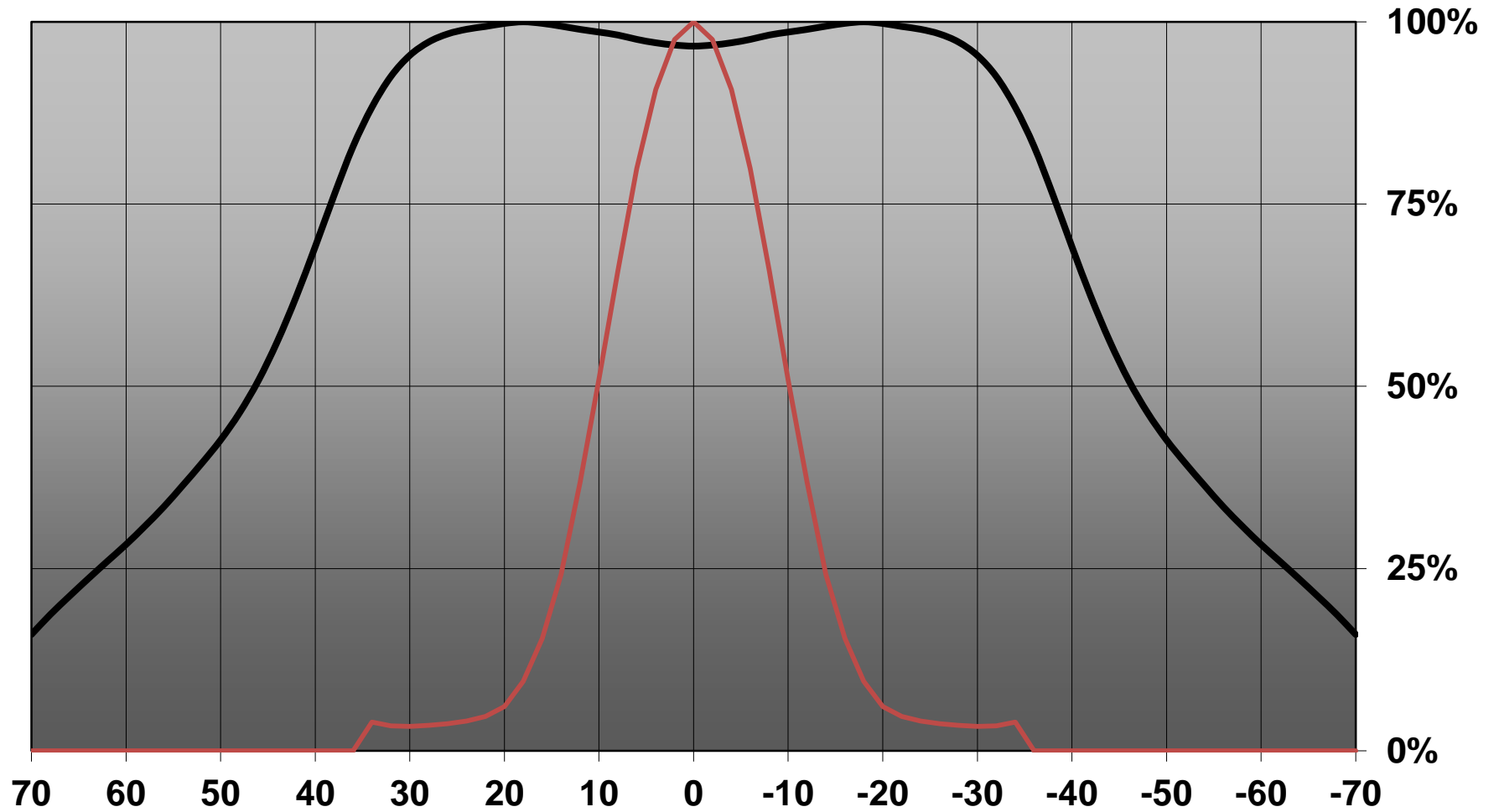

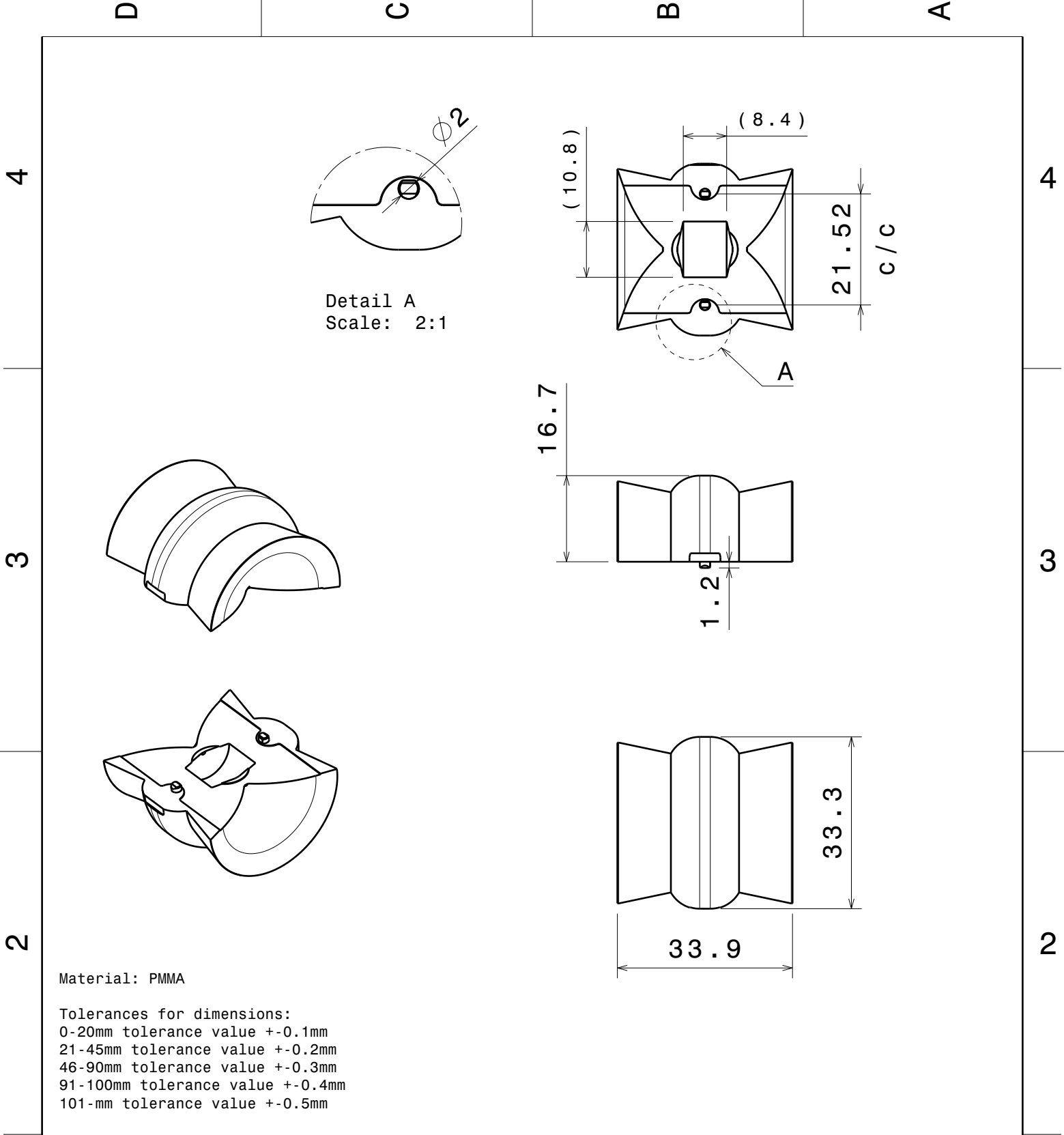

This drawing is our property.  
 It can't be reproduced  
 or communicated without  
 our written agreement.



Ledil Oy  
 Salorankatu 10  
 FIN 24240 SALO  
 Finland

**DRAWING TITLE**

**Datasheet FLARE-MAXI Lens**

**DRAWN BY**  
pv

**DATE**  
18.4.2012

**CHECKED BY**  
sn

**DATE**  
17.4.2012

**SIZE**  
A4

**DRAWING NUMBER**

**REV**  
1

**DESIGNED BY**  
hh

**DATE**  
6.4.2012

**SCALE**

1:1

**WEIGHT (g)**

**SHEET**

1/1

Luminaire: Ledil oy C13012\_FLARE-MAXI-D (Luxeon A 64lm @ 250mA) Efficiency=94%  
Lamps: 1 x Luxeon A 64lm @ 250mA

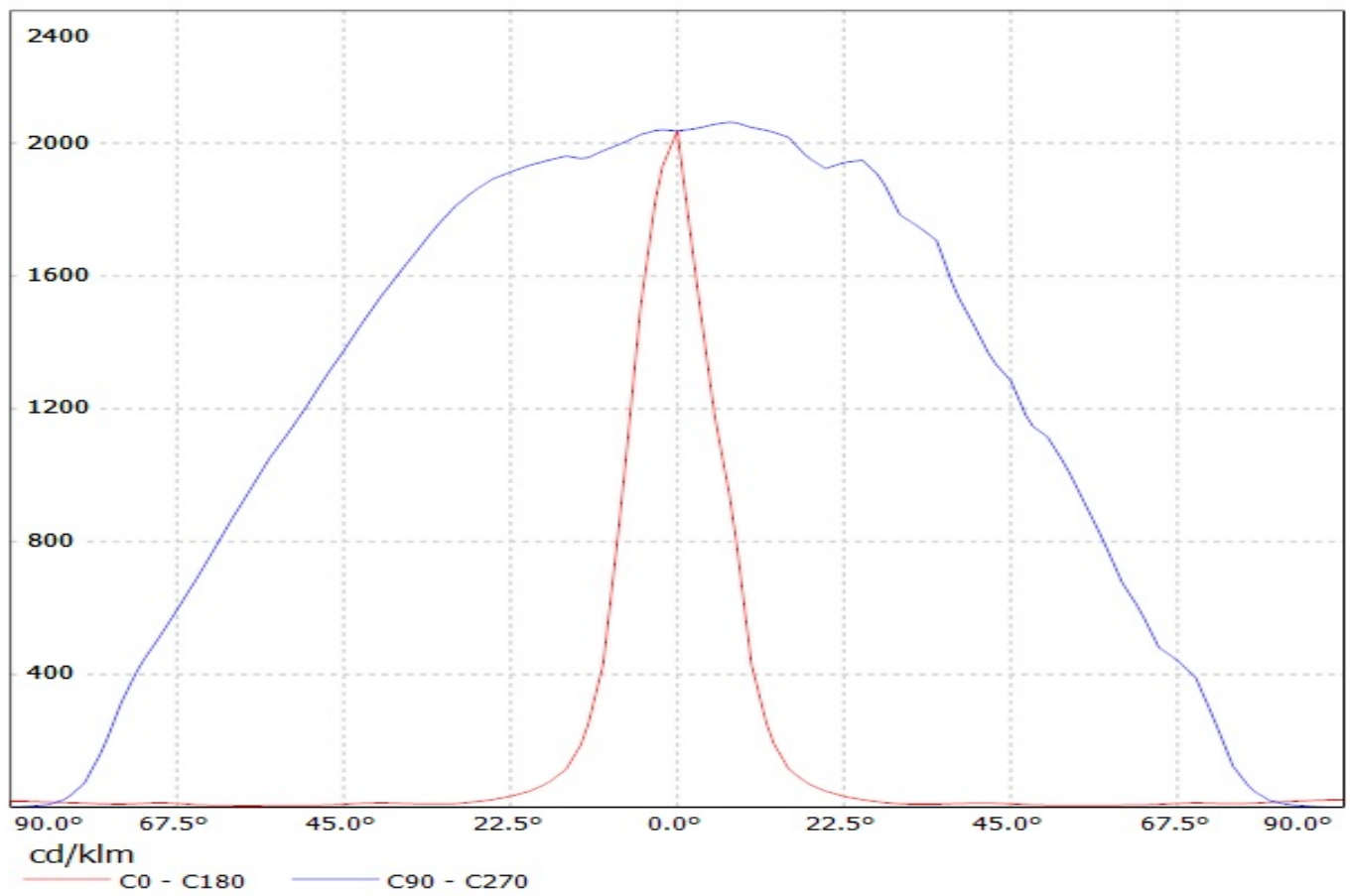

Luminaire: Ledil oy C13012\_FLARE-MAXI-D (Luxeon A 64lm @ 250mA) Efficiency=94%  
Lamps: 1 x Luxeon A 64lm @ 250mA

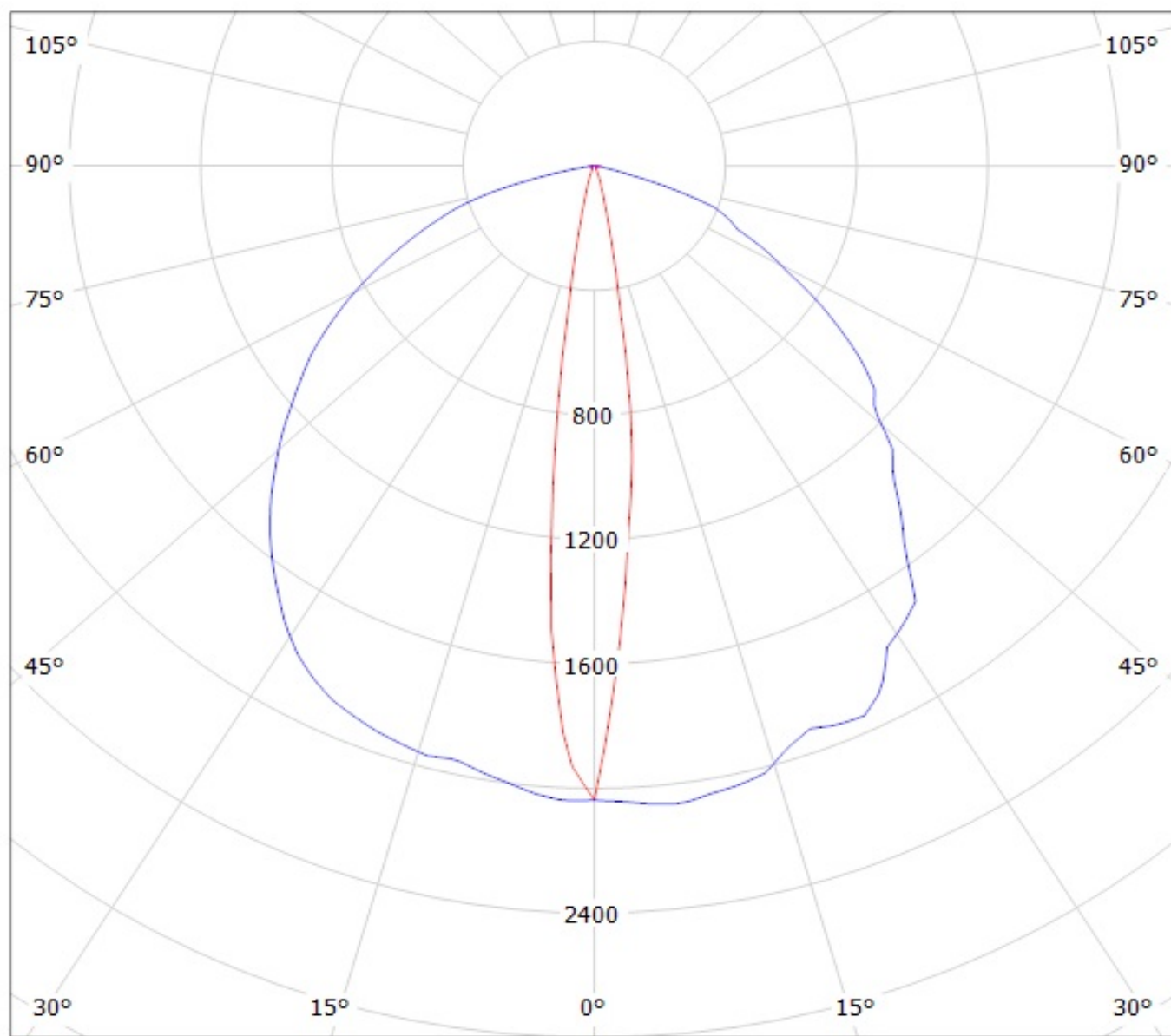

cd/klm

— C0 - C180

— C90 - C270