

# Monitor Risers



## Monitor Riser #91712

- Height adjustable from 2" to 4" with innovative stacking columns.
- Non-skid rubber foot rings ensure stability on any surface.
- Sturdy high-impact plastic supports up to 40 lb. or 15" monitors.
- Platinum and graphite color combination fits any home or office decor.



## Premium Monitor Riser #91717

- Innovative stacking columns provide 5 height adjustment levels (2 1/2" to 6 1/2") to raise your monitor to the most comfortable level.
- Durable plastic base doubles as paper storage shelf.
- Sturdy high-impact stacking columns support up to 60 lb. or 17" monitors.
- Platinum and graphite color combination looks great in every home and office decor.



### **Monitor Riser Plus #91713**

- Can be adjusted to five different heights with innovative stacking columns.
- A line-of-sight copyholder stores neatly under the monitor platform. along with a 2" storage drawer and organization tray.
- The drawer is sized to accept 8-1/2" X 11" and A4 paper.
- Cable/power cord guides allow for proper cable routing.
- Can sit on the the desktop or on top of CPU and is capable of holding up to 60 lbs.



### **Monitor Riser System #91716**

- Innovative stacking columns provide 5 height adjustment levels (2 1/2" to 6 1/2") to raise your monitor to the most comfortable level.
- Features a generous storage drawer, perfect for paper or various media and a convenient compartment tray for organizing your office supplies.
- Two speaker/media storage trays are included for the multimedia user.
- Also includes side mount copyholder that attaches to the platform on either side.
- Durable plastic base offers additional storage space.
- Sturdy high-impact plastic constructions supports up to 60 lb. or 17" monitors

### **Monitor Station #91734**

- Sleek design raises monitor to a more comfortable viewing height.
- Convenient pull-out draw with dividers stores various media and supplies (16 CDâs, 16 Zip Disks, 50 3.5" diskettes).
- Sturdy high-impact plastic supports up to 50lbs or 15" monitors.
- Platinum with graphite accents complements any decor.
- Unique drawer design allows space underneath for keyboard.

Monitor Riser Plus  
Support Moniteur Réglable Plus  
Eleva Monitor Plus  
Monitor-Stand Plus  
Monitor Riser Plus  
Monitor Standaard Plus

**FELLOWES**  
COMPUTERWARE™

## Instructions, Instrucciones, Anleitungen, Istruzioni, Instructies:

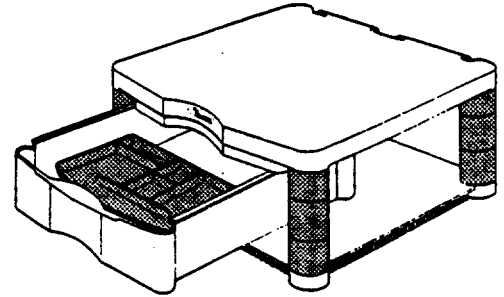
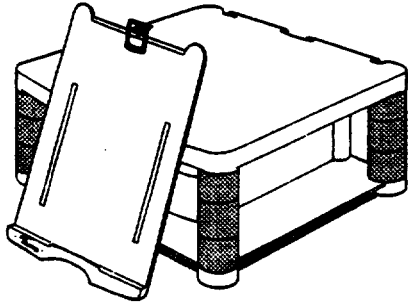

### **Note:**

According to the American National Standards Institute (ANSI), the top of your monitor should be placed at eye level as illustrated.

Monitor Riser supports monitors up to 60 lbs (27 kg).

### **Remarque:**

D'après l'Institut National Américain de Normes (ANSI), le haut du moniteur doit être placé au niveau des yeux conformément à l'illustration.

Le support moniteur peut supporter un moniteur jusqu'à 27 kg.

### **Nota:**

Según el Instituto Americano de Normas Nacionales (ANSI), la parte superior de su monitor debe colocarse al nivel de los ojos, como se muestra.

El eleva-monitor soporta monitores de hasta 27 kgs (60 libras).

### **Hinweis:**

Das Amerikanische Institut für Normung (ANSI) empfiehlt, den Monitor so aufzustellen, daß sich die Oberkante in Augenhöhe befindet (siehe Abbildung).

Monitor-Stand hält Monitore mit einem Gewicht von bis zu 27 kg.

### **N.B.:**

Secondo l'American National Standards Institute (ANSI), la parte superiore de vostro monitor dovrebbe trovarsi all'altezza dei vostri occhi così come viene illustrato.

Il Monitor Riser regge i monitors fino ad un peso di 27 kg.

### **Opmerking:**

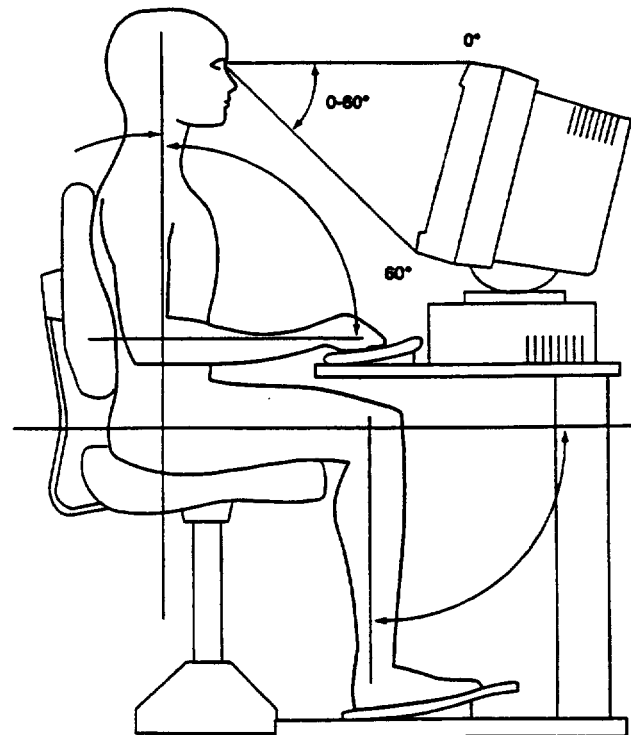

Volgens het Amerikaanse normalisatie-instituut ANSI dient de bovenkant van uw monitor, zoals aangegeven, op ooghoogte te worden opgesteld.

De monitorstandaard kan monitoren met een gewicht tot 27 kg. dragen.

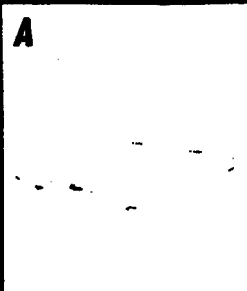
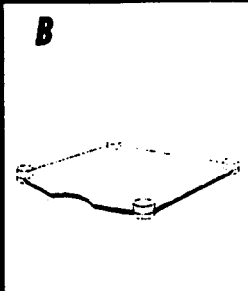
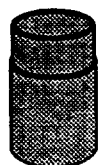

Monitor Riser Plus  
 Support Moniteur Réglable Plus  
 Eleva Monitor Plus  
 Monitor-Stand Plus  
 Monitor Riser Plus  
 Monitor Standaard Plus

**FELLOWES**  
 COMPUTERWARE™

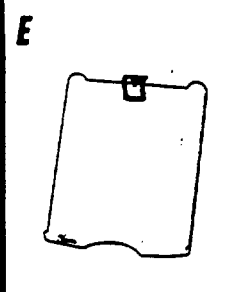
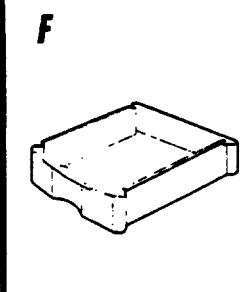
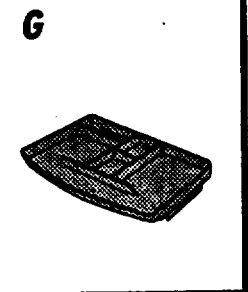
#91713	#		#		#		#
<b>A</b>	<b>1</b>	<b>B</b>	<b>1</b>	<b>C</b>	<b>8</b>	<b>D</b>	<b>4</b>
				 2 11/16" 68 mm		 1 13/16" 46 mm	
<b>E</b>	<b>1</b>	<b>F</b>	<b>1</b>	<b>G</b>	<b>1</b>		
							

**Instructions, Instrucciones, Anleitungen, Istruzioni, Instrucții:**

Alternate column arrangements provide 5-position height adjustment.

Les colonnes évolutives permettent un réglage de la hauteur sur 5 positions.

Las columnas ajustables permiten 5 posiciones de altura.

Alternative Anordnungen für flexible Höheneinstellung mit 5 Positionen.

Les sistemazioni a colonne alternate permettono una regolazione dell'altezza in 5 posizioni.

Door andere opstellingen van de kolomvormige dragers kunnen 5 verschillende hoogteposities worden ingesteld.

